

Agilent Analytical and Semipreparative Guard User Guide

Contents

Section 1: General guard column guidelines

Section 2: Fast guards (used for most Agilent InfinityLab Poroshell 120 and sub-2 μm (RRHT/RRHD) applications)

Section 3: Guard cartridges

Section 3A: See this section for 2.1 and 4.6 mm id guard cartridges with $\geq 5 \mu\text{m}$ particles

Section 3B: See this section for 2.1, 4.6, and 6.0 mm id guard cartridges with 3.5, 3.0, and 1.8 μm particles or for semipreparative (9.4 mm id) guard cartridges

Section 1: General guard column guidelines

- Eluents and samples should be filtered with a 0.45 μm filter before use. Visit <https://www.agilent.com/chem/filtration> for products and a selector tool.
- The same flow rate, pressure, and mobile phase restrictions that apply to the analytical column should remain for the guard column.

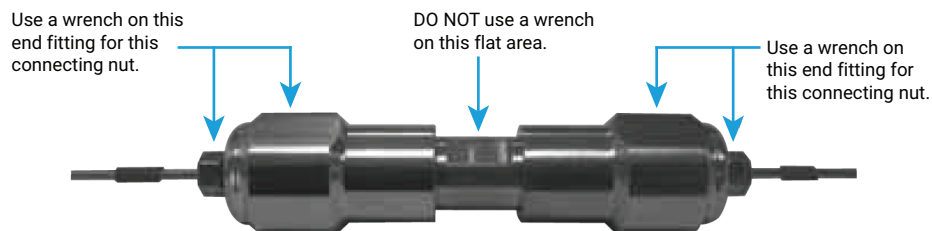

WARNING: To avoid loosening end fittings and causing column leakage, use wrenches as indicated above when connecting the guard column to the system.

Figure 1. An illustration demonstrating how to attach and tighten guards and other columns on an LC system.

Section 2: Fast guards



Introduction

Agilent Fast Guards are designed to protect high performance fast LC columns, such as the Rapid Resolution High Definition (RRHD), Rapid Resolution High Throughput (RRHT), and Agilent InfinityLab Poroshell 120 LC columns, with minimal impact on chromatographic performance. These guard columns are packed with the same particles and chemistries available in their respective HPLC/UHPLC columns.

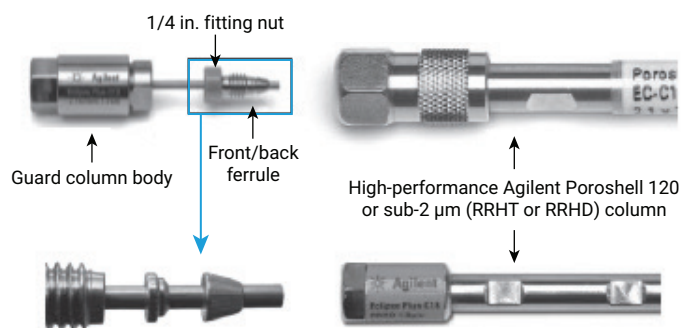

Figure 2. An illustration of the Agilent Fast Guards, ferrule positioning, and the types of compatible analytical columns.

Installing your guard column

Care must be taken during installation to properly seat the guard column capillary and ferrule securely within the LC column. This is to ensure a leak-free and low-dispersion union. To install the guard column, follow these steps:

1. Carefully remove the black rubber cap from the end of the guard column while ensuring that the fitting and ferrule (front and back) remain on the tubing.
2. Insert the guard column capillary into the inlet side of the LC column, so that the guard tubing is seated within the bottom of the column inlet.
3. Finger-tighten the 1/4 inch nut on the guard column into the analytical column.

4. Once it is finger-tight, use a wrench to adjust an additional 1/4 turn to securely swage the ferrule and ensure a tight, leak-free fit. If the guard remains loose, tighten an additional 1/4 turn until the ferrule is seated and the guard is leak free. To allow for variance and flexibility in fitting choice, the ferrule on the guard column does not arrive preswaged.
5. Attach the tubing from the instrument and apply a mobile phase flow through the guard.

Fast Guard care and use

- Fast Guards are one-piece guard columns and are manufactured for high performance. After the guard column becomes clogged or the lifetime is reached, dispose of the guard column.
- Do not disassemble the guard column. Disassembly of guard columns will compromise their stability.
- The guard hardware is rated to a temperature of 60 °C at the maximum operating pressure. Guards are stable to their corresponding maximum column pressures:

Guard Column Type	Pressure Limit (bar)
InfinityLab Poroshell 120 Fast Guard	600
AdvanceBio Fast Guard	600
Sub-2 µm Fast Guard	1,200

- Exceeding the pressure or temperature limits of the guard column will compromise the lifetime of the guard.

Remember:

Only tighten your columns at the nut.

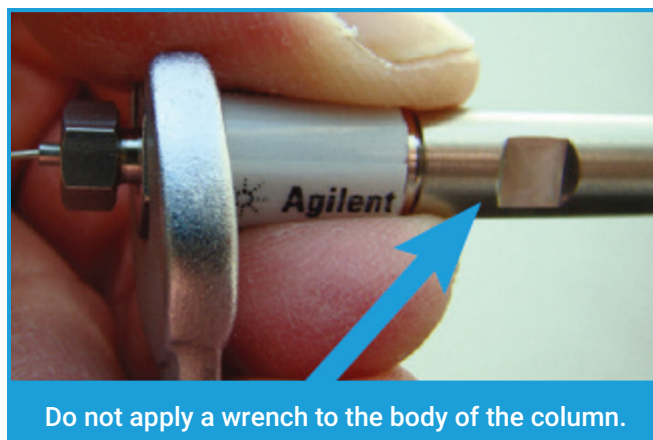

Figure 3. Tighten the fittings by applying a wrench to the nut at the top of the column. Applying a wrench to the body of the column may disassemble the column and may cause column failure.

Section 3: Guard cartridges



- See section 3A for 2.1 and 4.6 mm id guard cartridges with $\geq 5 \mu\text{m}$ particles.
- See section 3B for 2.1, 4.6, and 6.0 mm id guard cartridges with 3.5, 3.0, and 1.8 μm particles or for semipreparative (9.4 mm id) guard cartridges.

Section 3A

Introduction

The Agilent ZORBAX Reliance cartridge guard column series was developed to provide convenient, cost-effective protection for high-performance analytical columns. The cartridge components assemble quickly and easily to provide a high-efficiency, low dead volume column that seals with hand tightening against operating pressures of 400 bar. The reusable exit end fitting, with integrated 1/16 inch od tubing, adapts the cartridge guard column for direct connection to standard 1/16 inch LC fittings, and provides a standalone guard column system. The materials used in these guard cartridges are ZORBAX, ZORBAX StableBond, ZORBAX Eclipse, and Extend packings.

Guard column cartridges

The guard column cartridges provide physical (filtration) and chemical (adsorption) protection for analytical columns. They are packed with 5 μm media of identical chemistry to their corresponding analytical columns to provide the most effective protection. The guard column cartridges are unthreaded 2.1 mm id or 4.6 mm id \times 12.5 mm PPS polymer tubes with press-fit 2 μm porosity frits and are available in several stationary phases. A packed 4.6 mm id guard column cartridge has a void volume of less than 150 μL . A packed 2.1 mm id guard column cartridge has a void volume of less than 30 μL .

Guard column hardware kit

The Reliance Guard column hardware kit (p/n 820999-901) consists of four major components:

- Low volume guard column holder
- Inlet end fittings (2/pk)
- Exit end fitting with integrated column connector
- PEEK finger-tight fitting (see special note in Assembly guidelines section)

Assembly guidelines

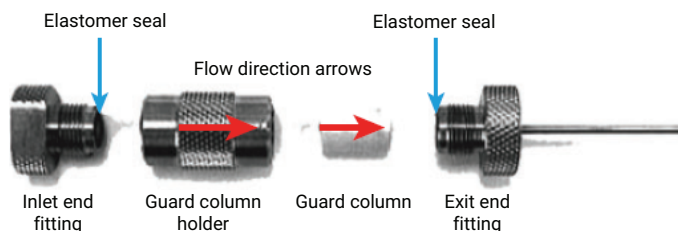

Figure 4. An exploded view of the Reliance Guard column kit, hardware (p/n 820999-901), and guard column cartridges with $\geq 5 \mu\text{m}$ particles.

1. Loosely screw the inlet end fitting into the inlet end of the guard column holder, leaving one or two threads showing.
2. Place the assembly on the benchtop, open end up.
3. Put the polymeric guard cartridge into the holder with the arrow on the cartridge pointing up.
4. With the guard column holder still vertical on the benchtop, screw the guard column exit end fitting into it until it is finger-tight.
5. Hand-tighten the full assembly by gripping both ends and turning them clockwise until tight.
6. To connect the guard column assembly to the analytical column, use the integral column connector provided (0.010 inch id \times 30 mm length).

Alternatively, you can use a different inlet end fitting (included) on the exit end of the guard column holder. This allows you to use other connecting tubing, if desired.

Note: PEEK finger-tight fittings should only be used when application conditions permit (for example, lower pressure operation, < 200 bar). For higher pressure applications, it is recommended that permanent 1/16 inch steel fittings (not included) be used to connect the guard system to the analytical column. Initial use of permanent steel fittings requires careful tightening inside the inlet fitting of an analytical column to properly set the depth of the ferrule.

Operational guidelines

- Do not use a mobile phase outside of the pH range of the analytical column being used.
- To avoid damaging the polymeric cartridge, only finger-tighten the cartridge holder.
- HPLC guards may be used for temperatures up to 80 °C. Do not exceed the maximum operating temperature of the analytical column.
- Routinely check for the presence and integrity of the perfluoroelastomer seals on the end fittings before every assembly operation. Replace the seals when necessary.
- Minimize the system dead volume to maintain efficiency.
- Do not reverse the guard cartridge. Only use in the recommended direction.
- Replace the guard cartridge when the system pressure has increased 10% from normal, or every 100 to 200 injections.
- Do not open the guard cartridges. The small particles are respirable.
- All cartridges are shipped dry. Before use, flush with methanol to wet the packing, then flush with mobile phase to ensure the highest column performance. Use the following minimum volumes:

Cartridge id (mm)	MeOH Wetting Volume (mL)	Mobile Phase Flush (mL)
2.1	0.5	2
4.6	3	10

Section 3B

Introduction

The ZORBAX cartridge guard column series has been developed to provide convenient, cost-effective, high-speed analyses. The cartridge components assemble quickly and easily to provide a high-efficiency, low dead volume column. The reusable cartridge end fittings adapt the cartridge column for connection to standard 1/16 inch LC fittings. The materials used in the cartridges are ZORBAX, ZORBAX StableBond, and ZORBAX Eclipse packings. There are three styles of guard columns: ZORBAX Rapid Resolution/Rapid Resolution HT, Reliance 3, and ZORBAX Semipreparative.

Guard column cartridges

The guard column cartridges provide physical (filtration) and chemical (adsorption) protection for analytical columns.

The ZORBAX Rapid Resolution (3.5 µm) and Rapid Resolution HT (1.8 µm) cartridge column series are recommended for high-speed analyses that require a moderate number of theoretical plates, such as high-throughput LC/MS applications. The cartridges are made of grade 316 stainless steel. The packing is retained in the cartridges by stainless steel frits, which are pressed into the cartridge. The Rapid Resolution cartridges, containing 3.5 µm particles, have 2 µm inlet frits and 0.5 µm outlet frits. The Rapid Resolution HT cartridges, containing 1.8 µm particles, have inlet and outlet frits of 0.5 µm porosity, and should be protected to minimize clogging of the inlet by debris in the mobile phase or samples.

Four types of Rapid Resolution cartridge columns filled with 3.5 µm packings are available: 2.1 × 15 mm, 2.1 × 30 mm, 4.6 × 15 mm, and 4.6 × 30 mm. Six types of cartridge column are available for Rapid Resolution HT columns, filled with 1.8 µm packings: 2.1 × 15 mm, 2.1 × 30 mm, 2.1 × 50 mm, 4.6 × 15 mm, 4.6 × 30 mm, and 4.6 × 50 mm. The 4.6 and 2.1 × 50 mm dimensions are also available as columns with fixed end fittings. The pressure limit on all cartridges is 400 bar.

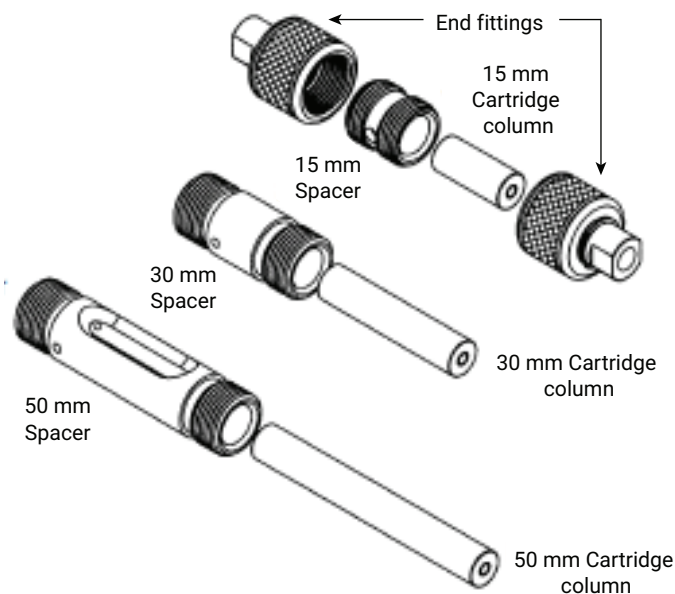

Figure 5. The hardware (p/n 820555-901) consists of the end fittings and a spacer. It is used with Rapid Resolution and Rapid Resolution HT guard cartridges.

The Reliance 3 cartridges provide shorter analysis time and savings on column and solvent costs. The cartridge components assemble quickly and easily to provide a high-efficiency, low dead volume column that seals with PEEK-encapsulated frit/gaskets at pressures up to 350 bar (5,000 psi) and temperatures up to 60 °C. The reusable cartridge end fittings adapt the cartridge column for connection to standard 1/16 inch LC fittings. The packings used are ZORBAX materials, identical to those used in traditional, high-quality ZORBAX HPLC columns, produced with compression fittings. The Reliance 3 cartridge column series uses a threaded stainless steel tube, 6 × 40 mm, packed with 3 µm ZORBAX media. The packing is retained by stainless steel frits which are pressed into the cartridge. The inlet frit is 2 µm and the void volume of the column is approximately 0.5 mL.

To eliminate galling of the threads, the sealing hardware and the cartridges are made from two different types of stainless steel. The actual sealing in Reliance columns is accomplished with reusable PEEK-encapsulated frit/gaskets, compressed at metal-to-metal sealing surfaces (for example, the column cartridge and the end fitting). The PPS polymeric guard column tubing is more solvent-resistant than PEEK and is engineered to make leak-tight seals against metal surfaces, without requiring gaskets. The Reliance 3 hardware is included with the guard cartridge.

The ZORBAX Semipreparative guard column has been developed to provide convenient, cost-effective protection for high-performance, lab-scale semipreparative columns. The cartridge components assemble quickly and easily to provide a high-efficiency, low dead volume column that seals at pressures up to 135 bar (2,000 psi). The PPS polymeric guard column tubing is more solvent-resistant than PEEK, and is specifically engineered to make leak-tight seals against metal surfaces, without requiring gaskets.

The reusable guard column end fittings adapt the cartridge guard column for connection to standard 1/16 inch LC fittings and provide a standalone guard column system. They are packed with 5, 6, or 7 µm ZORBAX media to provide the most effective protection. The guard column cartridges are unthreaded 9.4 mm id × 15 mm tubes with press-fit 2 µm porosity frits, and are available in a variety of reversed-phase and normal phase stationary phases. A packed guard column cartridge has a void volume of less than 800 µL.

The Semipreparative guard column hardware kit (p/n 840140-901) is used for 9.4 mm id cartridges and consists of three major components:

- Inlet fitting
- End fitting (PTFE-coated to prevent galling)
- Column connector (see note in Semipreparative assembly guidelines)

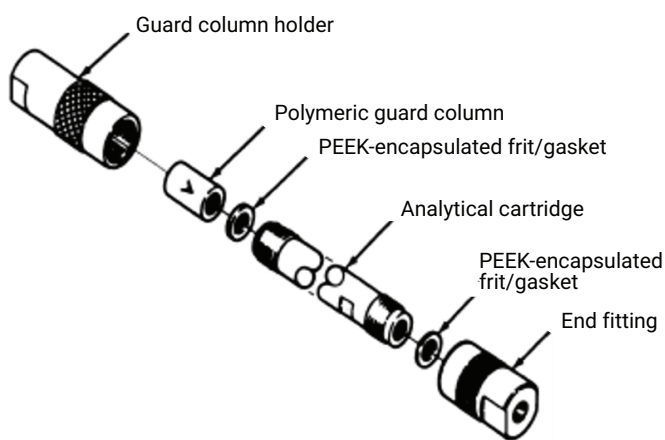

Figure 6. An exploded view of the Reliance 3 guard column. Stationary phases included in the 6.0 × 40 mm guards are ZORBAX SIL, ODS, CN, and C8.

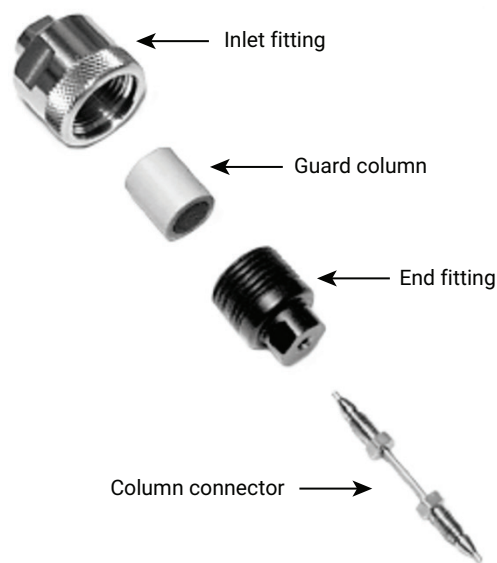

Figure 7. An exploded view of the ZORBAX Semipreparative guard column.

Guard column pressure rating summary

Guard Type/Dimensions	Maximum Pressure (Bar)
2.1 or 4.6 mm id; 3.5 μm	400
2.1 or 4.6 mm id; 1.8 μm	400
6.0 \times 40 mm; 3 μm	350
9.4 \times 15 mm	135

ZORBAX Rapid Resolution and Rapid Resolution HT (2.1 or 4.6 mm id) assembly guidelines

The standard configuration requires a column spacer, an analytical cartridge column, and two end fittings. The end fittings contain a perfluoroelastomer gasket to seal with hand tightening.

1. Screw the appropriate length spacer into one end fitting until only two or three threads remain visible.
2. Put the analytical column into the spacer, noting the direction of the flow arrow. (The flow through the column should always be in the direction of the arrow.)
3. Screw the other end fitting onto the spacer.
4. Hand-tighten both of the end fittings.

For your convenience, a wrench has been provided to aid in the removal of a spacer from an end fitting. To remove a spacer from an end fitting, engage the tooth end of the wrench in the hole through the side of the spacer, then rotate the wrench and the spacer in a counterclockwise direction.

Reliance 3 (6.0 \times 40 mm) cartridge assembly guidelines

The standard configuration requires a guard column holder, one or two PEEK-encapsulated frit gaskets, a polymeric guard column cartridge, an analytical cartridge, and an end fitting. The gaskets are placed at each steel-to-steel interface. The gasket must be placed flat in the fittings.

1. Place the guard column holder on the benchtop, open end up.
2. Put the guard cartridge into the holder with the arrow on the cartridge pointing up (to minimize clogging of the analytical cartridge, the flow through the guard column should always be in the direction of the arrow).
3. Place a PEEK frit/gasket on the outlet of the guard column cartridge and ensure it is concentrically aligned.
4. With the guard column holder still vertical on the benchtop, screw in the inlet end of the analytical cartridge column until snug.

5. Place the exit end fitting on the benchtop, open end up, and install a frit/gasket.
6. Screw in the exit end of the analytical column with the exit fitting remaining on the benchtop.
7. Use a wrench to tighten both ends before installing the column assembly on the LC. See Figures 1 and 3 in Sections 1 and 2 for proper wrench placement.

To install the column coupler, use an analogous procedure. First, screw one analytical cartridge approximately halfway into the coupler. Then, orient it vertically, open end up, and install a frit/gasket. Tighten the second cartridge on the gasket before changing the orientation. A PEEK frit/gasket must be used at both ends to seal metal-to-metal surfaces.

Semipreparative assembly guidelines

The standard configuration requires an inlet and outlet fitting, a semipreparative cartridge column, and a column connector.

1. Place the end fitting on the benchtop, open end up.
2. Put the guard cartridge into the holder with the arrow on the cartridge pointing down. (To avoid possible plugging of the semipreparative column, the flow through the guard column cartridge should always be in the same direction. The flow arrow is provided to show the user the correct direction of flow).
3. With the end fitting still vertical on the benchtop, screw on the inlet fitting until it is finger-tight.
4. Use a wrench to tighten the end fittings 1/8 to 1/4 turn before the guard column assembly is installed onto the HPLC. See Figures 1 and 3 in Sections 1 and 2 for proper wrench placement.
5. Connect the guard column assembly to the semipreparative column using the guard column connector provided (0.020 inch id \times 50 mm).

Note: The column connector tube and fittings are provided unassembled. Initial use requires careful tightening inside the guard column assembly end fitting and the inlet fitting of the semipreparative column to properly set the ferrules.

Operational guidelines for all guard types

- Do not exceed operating pressures (see the table in Guard column cartridges section).
- Do not use a pH outside the range of 2 to 8 (pH 3 to 8.5 for Diol).
- Do not exceed the maximum operating temperature of the guard columns (see the table in the Temperature limits section).

- Replace the guard cartridge when the system pressure has increased by 10% from normal or after every 100 to 200 injections.
- Do not open the guard cartridges. The small particles are respirable.
- Minimize the system dead volume to maintain efficiency.
- Do not reverse the guard cartridge. Only use in the recommended direction.
- All cartridges are shipped dry. Before use, flush with methanol to wet the packing, then flush with mobile phase to ensure the highest column performance. Use the following minimum volumes:

Cartridge id (mm)	MeOH Wetting Volume (mL)	Mobile Phase Flush (mL)
2.1	0.5	2
4.6	3	10
6.0	8	25
9.4	20	50

Temperature limits

Chemistry Type	Maximum Temperature at pH 2 to 6	Maximum Temperature (pH > 6)
ZORBAX	60 °C; 80 °C for semipreparative	60 °C (pH ≤ 8)
ZORBAX Eclipse	60 °C	40 °C (pH 6 to 9)
ZORBAX StableBond	90 °C (pH 1 to 6); 80 °C for semipreparative	40 °C (pH 6 to 8)

www.agilent.com

This information is subject to change without notice.

DE99026896

© Agilent Technologies, Inc. 2024
Printed in the USA, February 7, 2024
5994-7136EN