

February 2022, Issue 87



Page 1

ICP-MS Sample Preparation and High Matrix Sample Analysis

Pages 2-3

A Practical Approach to Analyzing High Matrix Samples Using ICP-MS

Pages 4-5

ICP-MS Interface Cones. Design Considerations for Optimum Analytical Performance

Pages 6

The Importance of Good Sample Preparation for Trace Level Analysis by ICP-MS

Page 7

News and Highlights from the Winter Conference on Plasma Spectrochemistry

Page 8

Webinars on Choosing the Best Elemental Analysis Instrument for Your Lab and New ICP-MS Publications

ICP-MS Sample Preparation and High Matrix Sample Analysis

In this issue of the Agilent ICP-MS Journal, we report from the most recent Winter Conference on Plasma Spectrochemistry. We also review some recent e-seminars that discussed sample preparation for trace level analysis by ICP-MS. Agilent applications chemists, together with representatives from leading suppliers of microwave digestion systems, provide tips on how to control contamination and ensure effective digestion of a range of sample types.

We also continue our series of articles exploring the basic principles of ICP-MS, this time looking at the critical role of the ICP-MS vacuum interface. We show how a well-designed interface provides high ion transmission without compromising vacuum quality. To illustrate the surprising capability of a modern ICP-MS, we summarize a recent application note on the analysis of undiluted seawater.

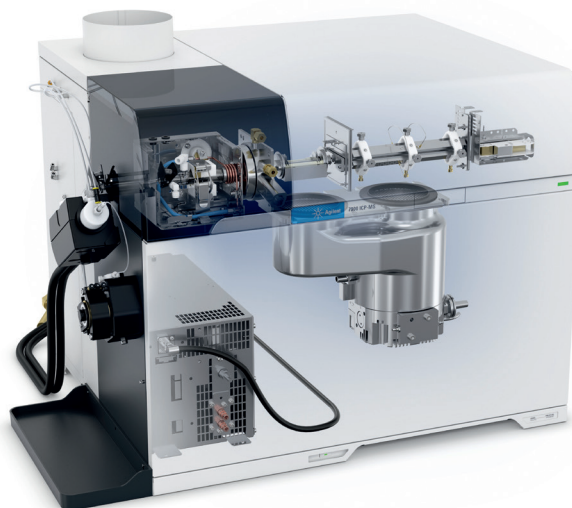

Figure 1. A look inside the Agilent 7900 single quadrupole ICP-MS.

A Practical Approach to Analyzing High Matrix Samples Using ICP-MS

Tetsuo Kubota and Ed McCurdy, Agilent Technologies, Inc.

High matrix sample analysis by ICP-MS

A significant limitation of early ICP-MS instruments was their poor tolerance of high levels of total dissolved solids (TDS). In these early instruments, the sample introduction and plasma operating conditions were usually optimized to give the highest possible sensitivity, leading to compromised matrix tolerance (Figure 1).

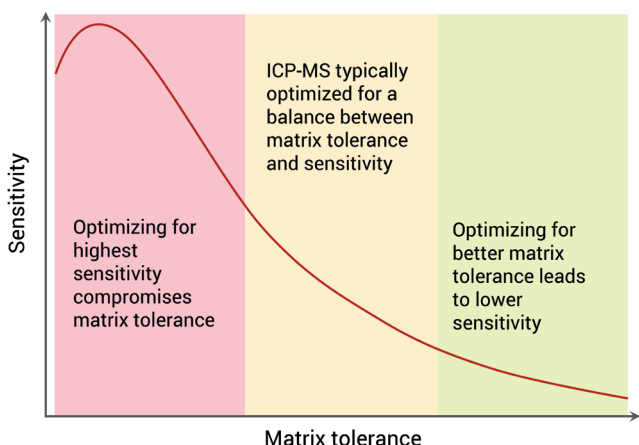

Figure 1. ICP-MS hardware design and operating conditions must strike a balance between sensitivity and matrix tolerance.

The relatively poor matrix tolerance of early ICP-MS systems led to a recommended maximum matrix level of <0.2% or 2000 ppm TDS for routine analysis. This limit meant that samples often had to be diluted before analysis, either manually or using an online autodilutor. But offline sample dilution is time-consuming, prone to errors, and can introduce contamination, while online autodilution devices are expensive and add complexity, increasing the risk of leaks and blockages.

The historical limit of 0.2% TDS still applies to many modern ICP MS instruments, where plasma conditions are still optimized to maximize sensitivity at the expense of matrix tolerance.

However, ICP-MS is now accepted as the preferred technique for multi-element analysis across a wide range of industries. As a result, the technique is often used to analyze high matrix samples. ICP-MS is also widely used in high throughput commercial laboratories, where the pressure to achieve high productivity and fast turnaround mean labs try to avoid sample processing before analysis.

To address these changing requirements, Agilent R&D engineers have focused on increasing ICP-MS matrix tolerance to enable large batches of high matrix samples to be analyzed routinely. Developments have included innovations in sample introduction and aerosol processing, more efficient energy transfer from the plasma, and increased ion transmission through the interface, ion lens, and mass spectrometer. As a result, Agilent ICP-MS users can use plasma conditions that provide excellent matrix tolerance while still achieving sensitivity comparable to or better than other, less robust ICP-MS systems.

Plasma robustness and matrix tolerance

The ability of an ICP-MS to routinely analyze high matrix samples is mainly dependent on the robustness of the plasma. The plasma must be able to decompose the sample matrix and dissociate interfering molecular ions while retaining sufficient energy to ionize the analytes. Plasma robustness in ICP-MS is monitored using the ratio of the signal of CeO⁺ to Ce⁺ (CeO/Ce). The CeO/Ce ratio indicates the efficiency with which the plasma can decompose the strongly bound CeO molecule.

The robust, matrix tolerant plasma of an Agilent ICP-MS typically operates at around 1 – 1.5% CeO/Ce, or lower. Operating under less robust conditions (higher CeO/Ce ratio) leads to incomplete matrix decomposition, matrix build-up on the ICP-MS interface cones, and signal drift.

Ionization suppression

It takes a lot of plasma energy to decompose a high sample matrix, leaving less energy to ionize analytes. This effect particularly impacts poorly ionized analytes, such as As, Se, Cd, and Hg, which require more energy to ionize. Easily ionized matrix elements, such as Na and K, have an even greater impact on analyte ionization, as these matrix elements yield a large number of free electrons when ionized. The free electrons preferentially recombine with the poorly ionized analyte ions, reducing ionization and therefore sensitivity.

This effect – known as ionization suppression – can lead to severe signal loss for poorly ionized analytes in the presence of a high salt matrix. A robust plasma has more energy in total, so more energy remains to ionize poorly ionized analytes, even after decomposing a sample matrix containing high salt levels.

Routine high matrix sample analysis

Analysis of poorly ionized trace elements in samples that contain a high level of easily ionized matrix elements can be considered a “worst case” scenario for ICP-MS. Yet this is exactly what is involved in the analysis of toxic trace elements As, Cd, and Hg in seawater, as required for routine monitoring of coastal fisheries, for example.

An Agilent 7850 ICP-MS with Agilent Ultra High Matrix Introduction (UHMI) aerosol dilution system was used to analyze undiluted seawater samples. UHMI is widely accepted as a robust and simple approach for extending ICP-MS matrix tolerance to percent levels of TDS (1).

The seawater samples analyzed included a synthetic seawater, a natural seawater, and a seawater CRM (NMIAX014 Trace Elements in Sea Water). Spiked samples were prepared for each of the seawater samples. More details are given in reference (2).

Spike recovery and stability in undiluted seawater

To demonstrate the robustness of the 7850 ICP-MS for routine analysis of undiluted seawater, 120 seawater samples and 30 standards and QC samples were analyzed repeatedly for seven hours. Spike recoveries for two seawater samples and recoveries for the certified elements in the seawater CRM are shown in Figure 2.

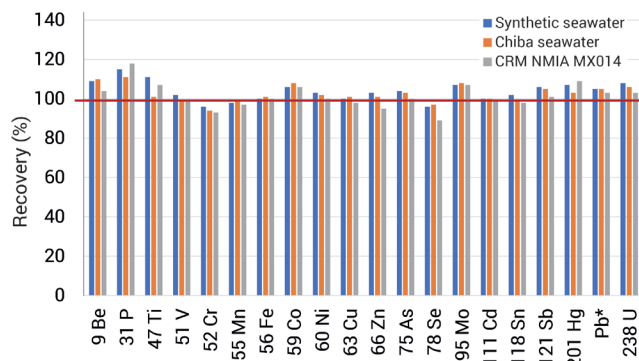

Figure 2. Accurate spike recoveries for analytes – including poorly ionized elements – in undiluted seawater samples. *Pb was measured as the sum of the three most abundant isotopes, 206, 207, and 208.

Recoveries were mostly within $\pm 10\%$ of the spike or certified concentrations, confirming the matrix tolerance and accuracy of the 7850 ICP-MS method.

Figure 3 shows the internal standard (ISTD) signals remained stable throughout the seven-hour run. The alternating high and low ISTD signals show the effect of the high salt matrix on physical sample transport and nebulization processes. ISTD correction ensured accurate quantitative analysis throughout the analysis.

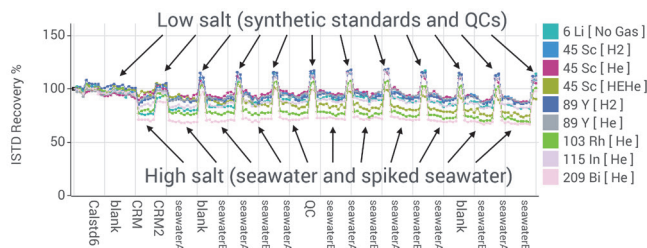

Figure 3. Internal standard signals for undiluted seawater analysis.

Conclusion

The study demonstrates the suitability of the Agilent 7850 ICP-MS with UHMI and optional Agilent ISIS 3 DS system for the long-term analysis of multiple elements in undiluted seawater samples.

References

1. Ultra High Matrix Introduction (UHMI), Agilent ICP-MS technology brief, [5994-1170EN](#)
2. Analysis of Undiluted Seawater using ICP-MS with UHMI and Discrete Sampling, [5994-4467EN](#)

The ICP-MS Interface. Design Considerations for Optimum Analytical Performance

Ed McCurdy and Abe Gutierrez, Agilent Technologies, Inc.

The ICP-MS vacuum interface

Mass spectrometers (MS) and ion detectors work best when they are operated under high vacuum (low pressure). Operating the MS at low pressure reduces ion scattering, increases transmission, improves peak shape, and reduces background noise. Many MS instruments are enclosed systems – where the ion source is inside the vacuum chamber – making it relatively easy to maintain the low pressure needed for optimum MS operation. But the plasma ion source of an ICP-MS is operated at atmospheric pressure, open to the laboratory environment, so ions must pass through an interface into the high vacuum region. The ICP-MS vacuum interface must therefore perform two conflicting roles:

1. Transfer ions from the plasma (at atmospheric pressure) to the MS (in the high vacuum region).
2. Maintain the lowest possible pressure in the vacuum region for optimum MS performance.

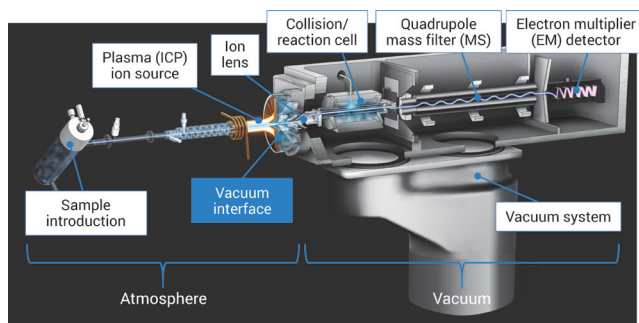

Figure 1. The ICP-MS vacuum interface transfers ions from the plasma into the high vacuum region.

The ICP-MS interface consists of a series of conical plates or “cones”, which have small orifices or apertures in them. The cones are water-cooled to prevent damage due to the high temperature plasma and are typically manufactured from solid nickel (or nickel with a copper base for improved electrical and thermal conductivity).

The interface components used as standard on Agilent ICP-MS systems (except semiconductor configurations) comprise a Ni sampling cone with a copper base, and a solid Ni skimmer cone, as shown in Figure 2.

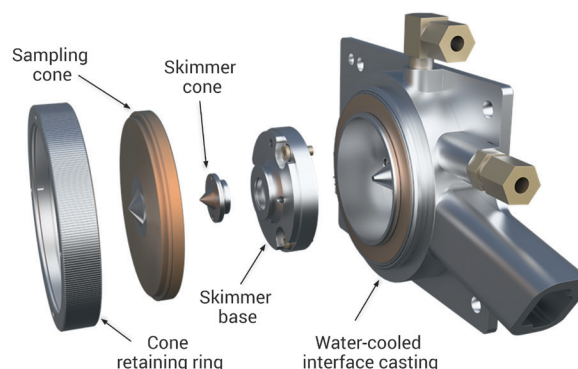

Figure 2. Interface components of an Agilent ICP-MS.

For applications that require the best corrosion resistance, platinum-tipped and nickel-plated cones are available.

ICP-MS vacuum interface design considerations

The ideal (lowest) vacuum pressure would be achieved with no cone apertures at all, but clearly that is not practical, as it would also give no ion transmission. A well-designed interface must work with the rest of the ICP-MS system to deliver the best combination of matrix tolerance, sensitivity, background, and MS performance.

An optimized interface design should also:

- Control the amount of sample matrix that passes into the vacuum chamber, helping to reduce maintenance in the high vacuum region.
- Reduce space charge effects by limiting the transfer of plasma gas ions (Ar^+ , ArH^+ , O^+ , O_2^+ , NO^+ , etc.), while maintaining transmission of analyte ions. Lower space charge reduces mass bias, giving higher sensitivity and lower detection limits for light ions.

Interface design and matrix tolerance

It is a common misconception that larger interface cone apertures prevent matrix deposition and so reduce signal drift. In reality, matrix deposition on the interface cones is mainly controlled by the robustness of the plasma (7). On an ICP-MS system with poor plasma robustness (CeO/Ce ratio >2%), a larger cone orifice might be necessary to delay the cone clogging that causes signal drift. But the larger cone aperture will also allow more of the undissociated matrix to pass through the interface and enter the high vacuum region, as shown in Figure 3.

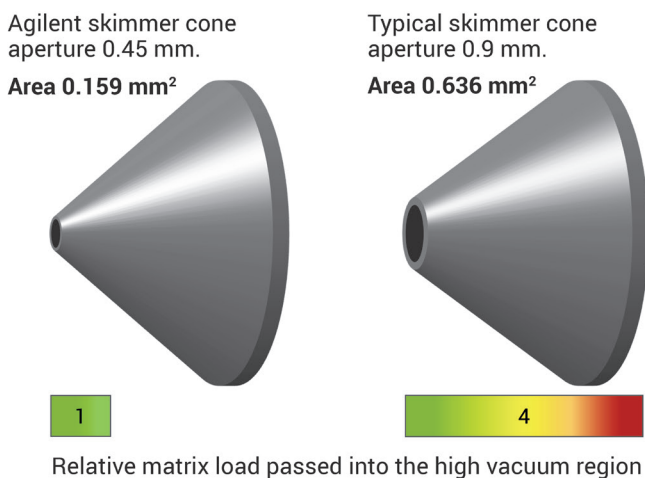

Figure 3. A skimmer cone with a 2x larger diameter aperture allows 4x more sample matrix to enter the high vacuum region.

A better way to control matrix deposition on the interface cones is to use more robust plasma conditions (lower CeO/Ce ratio). A more robust plasma decomposes the sample matrix more effectively, so there is less undissociated material to deposit on the cones. Agilent ICP-MS systems are routinely operated with the most robust plasma conditions of any ICP-MS. Typically the CeO/Ce ratio is around 1.0% for normal sample types, and as low as 0.3% CeO/Ce for high matrix samples. This CeO/Ce ratio is approximately 10x lower than the level typically achieved on some non-Agilent ICP-MS systems, indicating 10x better sample matrix decomposition.

Ten times better matrix decomposition and four times less matrix passing through the skimmer mean that 40x less matrix enters the vacuum system of an Agilent ICP-MS compared to less well-designed systems.

A further approach that can help prevent drift due to matrix deposition is to control the operating temperature of the skimmer cone tip. Agilent ICP-MS systems use carefully selected materials and an optimized skimmer base design to ensure that the skimmer cone tip operates at a precisely controlled, elevated temperature (Figure 4).



Figure 4. Left: Stainless steel skimmer base used with Ni skimmer cone. Right: Brass skimmer base used with Pt-tipped skimmer cone.

Careful control of the skimmer tip temperature prevents condensation of any residual matrix material and molecular species that pass through the interface. This control of operating temperature reduces the matrix deposition that is observed on systems where the skimmer is operated at lower temperature.

Conclusion

The ICP-MS vacuum interface must transfer ions from the plasma to the mass spectrometer while maintaining the lowest possible pressure in the vacuum region. The interface – together with the other components between the sample introduction and the ion lens – functions to deliver the optimum conditions for best performance of the mass filter and detector.

As discussed in a previous article (2), the various parts of an ICP-MS should work together to provide the ideal combination of good matrix tolerance and high sensitivity. On Agilent ICP-MS systems, the interface design combines with a robust plasma and an efficient, high-transmission off-axis ion lens to give the exceptional overall system performance characteristics.

References

1. Agilent ICP-MS Journal issue 81, [5994-2203EN](#)
2. Agilent ICP-MS Journal issue 85, [5994-3758EN](#)

The Importance of Good Sample Preparation Methods for Trace Level Analysis by ICP-MS

Bert Woods and Jenny Nelson, Agilent Technologies, Inc.

Achieving low detection limits with ICP-MS

Sample preparation is a critical part of achieving high quality data and low detection limits for elemental analysis by ICP-MS. In a recent virtual symposium entitled [Trace Element Detection Limits: What Every Spectroscopist Should Know](#), the importance of sample preparation was discussed in detail.

In the afternoon session, Eric Farrell, Product Specialist at Milestone Inc., explained the role of microwave digestion in achieving superior trace metals detection limits.

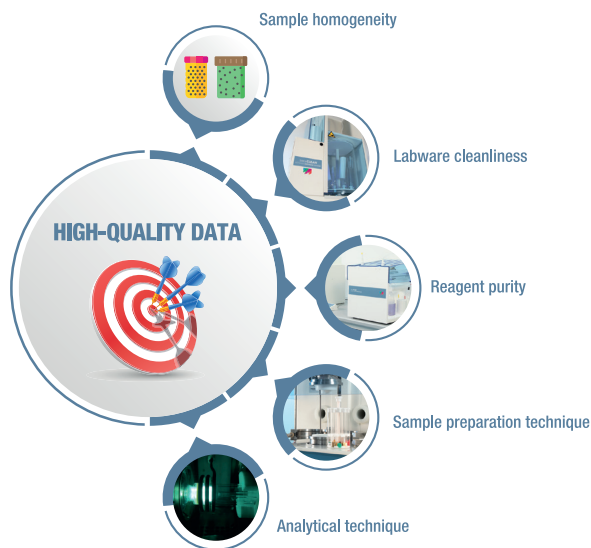

Figure 1. Factors that affect the quality of analytical data.
© Milestone Inc., 2021. Reproduced with permission.

For samples that need to be digested rather than just diluted, microwave acid digestion is increasingly used in preference to other techniques such as dry ashing, hotplate digestion, or Parr bomb.

Closed-vessel microwave digestion provides higher temperatures and pressures (T/P) than open vessel digestions, ensuring complete digestion while also often requiring less acid. Microwave digestion procedures are

faster and more consistent than alternative approaches, while the use of closed vessels prevents the loss of volatile elements such as Hg. The choice of microwave system (rotor-based or single-reaction chamber (SRC)) depends on the sample types and application requirements. The webinar detailed some of the key factors that affect detection limits including:

- Sample preparation technique, including choice of sample vessels, vials, and acids
- Quality/grade of reagents and cleanliness of sample preparation/digestion equipment
- Selection of the optimal sample mass to digest
- Dilution factor

Microwave acid digestion of food samples

In a recent [webinar](#) on food analysis, Elaine Hasty, Senior Applications Chemist at CEM, described how varied food samples were prepared using microwave acid digestion, ready for multi-element analysis by ICP-MS.



Forty samples were prepared in total, including duplicates of 10 different food types, two food samples each spiked at high and low levels, and three NIST SRMs. The batch also included method blanks with and without high- and low-level spikes. All samples and blanks were digested in a single batch using a MARS 6 microwave digestion system.

Elaine's presentation included tips on how best to prepare homogeneous samples and why care must be taken during sample weighing and transfer into the digestion vessels. Details of the microwave digestion method are provided in Agilent application note [5994-2839EN](#).

News and Highlights from the 2022 Winter Conference on Plasma Spectrochemistry

Chuck Schneider, Agilent Technologies, Inc.

Tucson, Arizona, USA, January 16–21, 2022

After the cancellation of so many events in 2020 and 2021 due to Covid-19, it was great to be back at the Winter Conference on Plasma Spectrochemistry in Tucson. To bring some color to the opening reception and to honor conference organizer Dr. Ramon Barnes, the Agilent team wore their brightest Hawaiian shirts. On-going travel restrictions meant that there were fewer conferees overall, but everyone who attended Agilent events during the week seemed to enjoy themselves. Highlights included hands-on software workshops — designed to improve skills around method development, method optimization, and reporting.

Steve Wall and Chris Conklin, Agilent ICP-OES Product Specialists, gave a lunch seminar on Powering the Lab of the Future with “smart” ICP-OES features. Agilent ICP-MS Specialists Abe Gutiérrez, Jenny Nelson, and Mark Kelinske presented lunch seminars on the latest developments in single quadrupole and triple quadrupole ICP-MS (ICP-QQQ). Special thanks to Dr. Melanie Barboni, from Arizona State University, who gave the keynote presentation at the ICP-QQQ User Group Meeting. Naoki Sugiyama, Agilent ICP-MS Product Manager, provided an update on ICP-QQQ, leaving plenty of time for informal discussions. On Wednesday evening, guests at the Agilent Customer Appreciation Event celebrated the 10th anniversary of ICP-QQQ with dancing, stargazing, and wonderful food.

Themes of the 22nd conference in biennial series

Popular themes of the conference included single nanoparticle and single cell analysis, biomedical research, laser ablation, speciation, and isotope ratio and isotope dilution. A workshop on cannabis analysis was also held. ICP-QQQ remains the hot topic in plasma-based instrumentation. For the first time, ICP-QQQ posters outnumbered those on single quad ICP-MS.

Poster presentation overview

A review of the posters presented during the conference showed that clinical research, pharmaceuticals, laser ablation, nuclear, food, environmental, single cells and nanoparticles were the main topics of interest. The poster count confirmed that Agilent ICP-MS instruments were the most widely used, being mentioned in 44% of the posters.

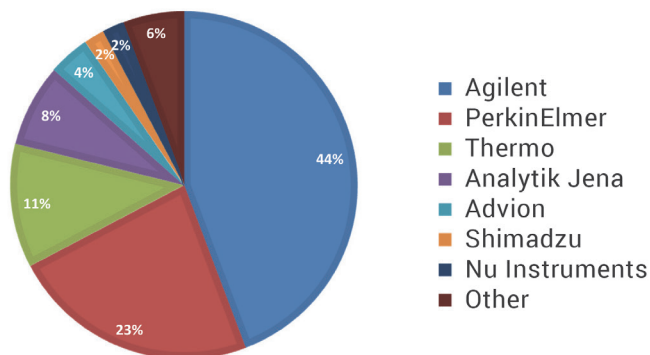

Working together



The Agilent atomic spectroscopy team presented 25 posters or oral presentations, chaired conference sessions and workshops, and hosted six different customer events.

Looking ahead: The [European Winter Conference on Plasma Spectrochemistry](#) will take place in Ljubljana, Slovenia from January 29 to February 3, 2023.

Which is the best elemental analysis instrument for your lab? Get inside knowledge from the Agilent atomic spectroscopy team

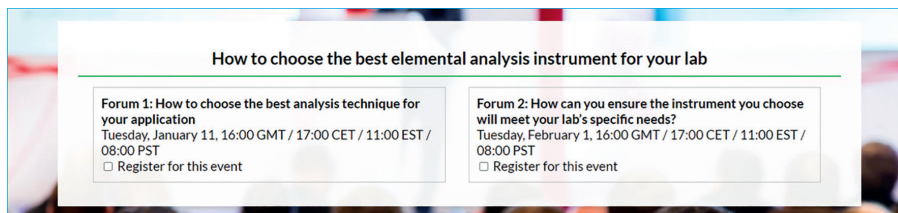

Choosing the best atomic spectroscopy technique for your lab's needs can be confusing. Instrument capabilities overlap while lab and regulatory requirements change over time. In a series of online forums, experienced members of the Agilent atomic spectroscopy team discuss several common applications and laboratory scenarios. They explain the pros and cons of each atomic spectroscopy technique for each situation. The discussion forums will help you:

- Understand the key differences between atomic spectroscopy techniques
- Learn how to plan an evaluation that is relevant to your lab's daily work to help you identify the critical differences between instruments.

Moderator: Ross Ashdown; **presenters:** Ed McCurdy, ICP-MS Product Marketing; Dr Elizabeth Kulikov, ICP-OES Product Manager; and Milos Ridesic, Applications Chemist for ICP-OES, MP-AES, and AAS.

Link to the two recorded forums hosted by Select Science: <https://view6.workcast.net/AuditoriumAuthenticator.aspx?cpak=6140127235089763&pak=5932768662768021>

Latest Agilent ICP-MS publications

- **Application note:** Determination of Hexavalent Chromium in Drinking Water by Ion Chromatography (IC)-ICP-MS, [5994-4295EN](#)
- **Application note:** Determination of Extractable and Leachable Elements Using ICP-MS, [5994-4340EN](#)
- **Application note:** Analysis of Undiluted Seawater using ICP-MS with Ultra High Matrix Introduction (UHMI) and Discrete Sampling (DS), [5994-4467EN](#)
- **Application note (updated):** High-Throughput, Multi-Element Analysis of Milk and Milk Powder Using ICP-MS, [5991-6185EN](#)

This information is subject to change without notice.

© Agilent Technologies, Inc. 2022
Published in the USA, January 27, 2022
5994-4529EN
DE43294262

