

Application News

No.L440

High Performance Liquid Chromatography

LC/MS/MS Analysis of Impurities in Active Pharmaceutical Ingredients Using the Co-Sense for Impurities System

Detection of impurities in active pharmaceutical ingredients (APIs) is often conducted using an HPLC-UV method. However, qualitative and quantitative analysis of impurities requires not only the separation of the impurities from the major component, but also separation among impurities themselves. The time and effort required to establish effective analytical conditions for this type of analysis are significant. Furthermore, the source of the impurity, whether it be the sample itself or some external factor associated with a particular lot, must also be determined. Here we demonstrate analysis of an impurity in an API using the 2-dimensional LC/MS/MS separation feature of the Co-Sense for Impurities System.

■ LC/MS Analysis of an Impurity Peak

Here we conducted measurement of a sample solution of rabeprazole sodium (1 mg/mL) according to the method specified in the Japanese Pharmacopeia. The analytical conditions are shown in Table 1. The Co-Sense for Impurities system with the configuration shown in Fig. 1 was used, and analysis was conducted using the red-colored segment of the flow line. The LC-UV chromatogram is shown in Fig. 2.

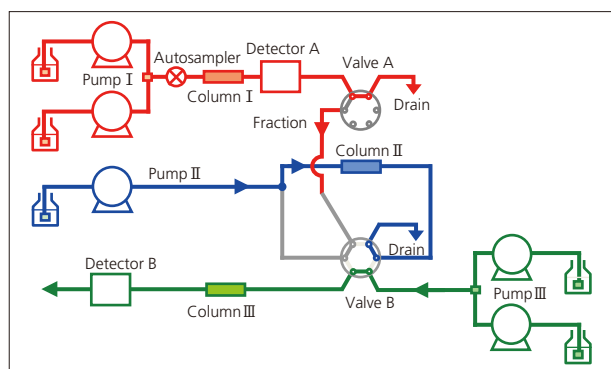

Fig. 1 Flow Diagram

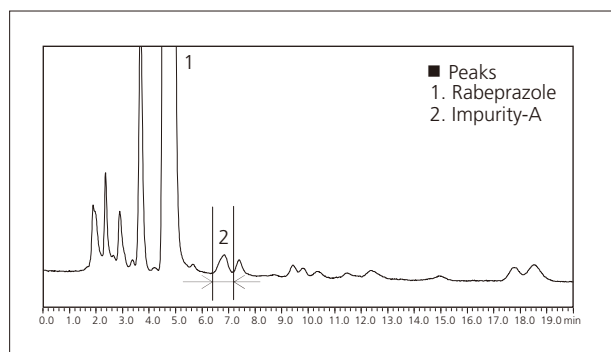

Fig. 2 LC-UV Chromatogram of Rabeprazole Sodium

Table 1 Analytical Conditions

Column (I)	: Shim-pack VP-ODS (150 mm L. × 4.6 mm I.D., 4.6 μm)
Mobile Phase	: Methanol / 50 mmol/L Phosphate buffer pH7.0 (3/2)
Flowrate	: 1.0 mL/min
Column Temp.	: 30 °C
Injection Volume	: 20 μL
Detection (A)	: UV 290 nm

MS detection requires analysis to be conducted using a volatile mobile phase. Flow lines with volatile additives in Fig. 1 are shown in blue (trap) and green (2nd separation).

In the analysis, valve A of Fig. 1 is switched during the elution of the impurity peak from the red flow line. The impurity peak is introduced into the blue-colored flow line, where it is mixed with volatile mobile phase and concentrated on column (II). Then, valve B is switched for elution and separation on column (III) with volatile mobile phase in the green flow line. The analytical conditions for that process are shown in Table 2.

Table 2 Analytical Conditions

Column (II)	: STR-ODS II (10 mm L. × 4.6 mm I.D., 5 μm)
Mobile Phase	: 100 mmol/L Ammonium Acetate
Flowrate	: 5.0 mL/min
Column (III)	: Shim-pack XR-ODS (50 mm L. × 2.0 mm I.D., 2.2 μm)
Mobile Phase	: Methanol / 10 mmol/L Ammonium Acetate (3/2)
Flowrate	: 0.2 mL/min
Detection (B)	: LCMS-8030 (ESI)

We conducted MS measurement in scan mode of impurity peak A (peak area approximately 0.06 % of the API peak) with an approximate retention time of 6.8 minutes as shown in Fig. 2, and the mass chromatograms of m/z 394.1, m/z 508.2 and m/z 569.2 using electrospray ionization in positive mode are shown in Fig. 3. These peaks showed nearly identical elution patterns when using direct LC/MS analysis of the sample solution. However, using the 2-dimensional enhanced separation, three impurity peaks (IM1 – IM3) were all separately distinguishable.

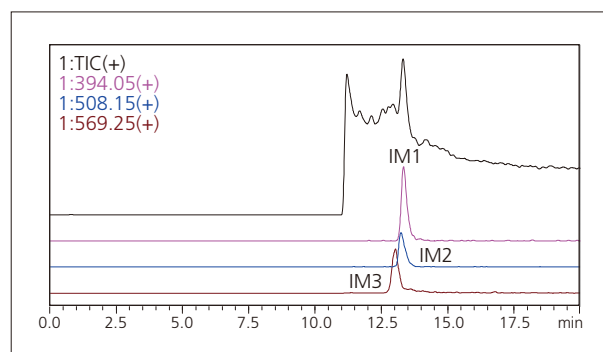

Fig. 3 Mass Chromatograms of Impurity-A Peak

Structure Prediction and MRM Analysis of Impurities

After conducting a product ion scan of the precursor ion at m/z 508.2, we predicted the structure of the impurity IM2 through comparison with the API. Fig. 4 shows the obtained product ion spectrum. These results indicate that the impurity is a benzimidazol-2-thiol derivative of the API.

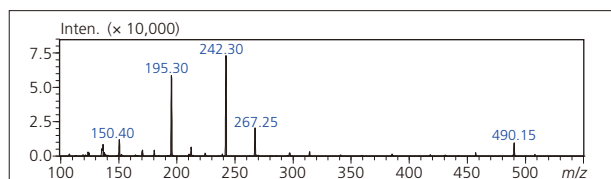
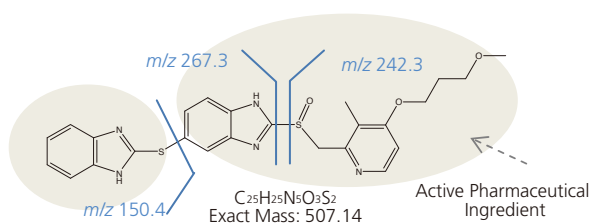

Fig. 4 Product Ion Spectrum for m/z 508.2



In addition, MRM measurements were conducted for the impurities IM1 – IM3. Using this method, we achieved excellent repeatability by conducting replicate measurements of the sample solution, in addition to excellent linearity with different sample injection volumes.

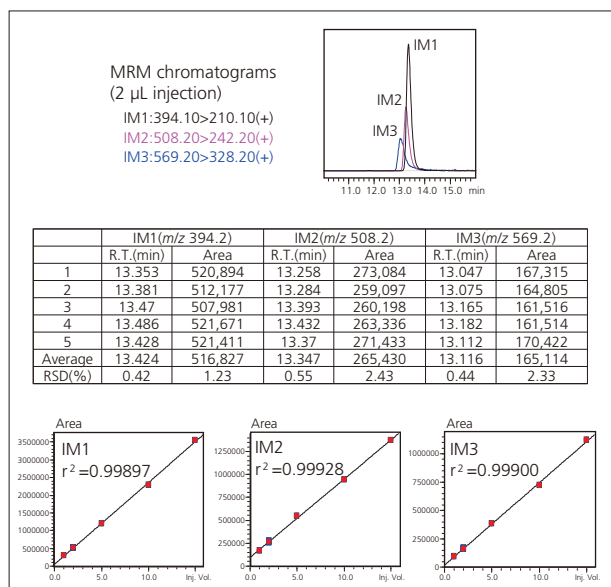

Fig. 5 MRM Analysis of Impurities IM1 - IM3

2-Dimensional Separation of Impurity Peak

Using this LC/MS/MS system, we conducted an in-depth examination of the separation obtained using UV detection of impurity peak A (Peak 2 of Fig. 6), which we confirmed to have eluted simultaneously as three separate impurity components.

As a result, by replacing mobile phase A in the second dimension from the aqueous solution of ammonium acetate (chromatogram (2), Fig. 6) to aqueous acetic acid (chromatogram (1), Fig. 6), the impurity separation was improved.

In addition, Fig. 6 shows the LC-UV chromatograms in which all the vertical axes have been normalized. Compared to the original impurity peak A obtained from just the first separation alone, shown at left, the peak intensity is much greater when using the second separation. These results indicate that both separation and sensitivity can be improved using the Co-Sense for Impurities System.

Table 3 Analytical Conditions

Column (II)	: STR-ODSII (10 mm L. \times 4.6 mm I.D., 5 μ m)
Mobile Phase	: 10 mmol/L Ammonium Acetate
Flowrate	: 5.0 mL/min
Column (III)	: Shim-pack XR-ODS (50 mm L. \times 2.0 mm I.D., 2.2 μ m)
Mobile Phase	: A; (1) 0.1 % Acetic acid aq. (2) 10 mmol/L Ammonium Acetate B; Methanol
Time Program	: B CONC 40 % (0 min) \rightarrow 65 % (5 min) Mixer : 180 μ L
Flowrate	: 0.2 mL/min
Detection (B)	: UV 290 nm

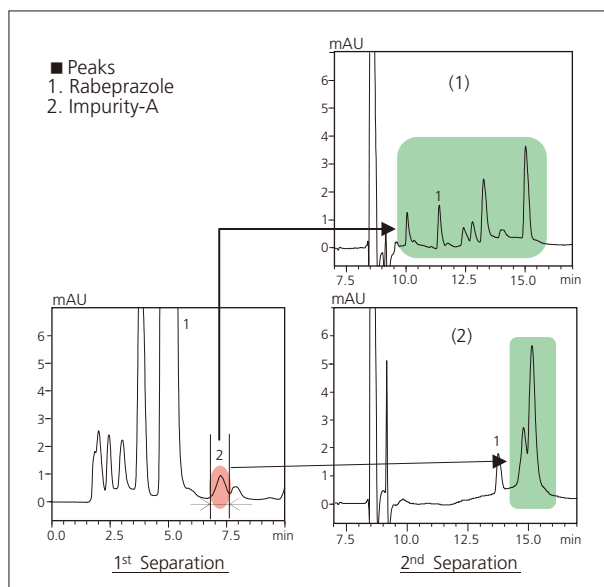

Fig. 6 2-Dimensional Separation of Impurity-A Peak