

UV-VIS Spectrophotometers Accessories

# UV-VIS Series Accessories

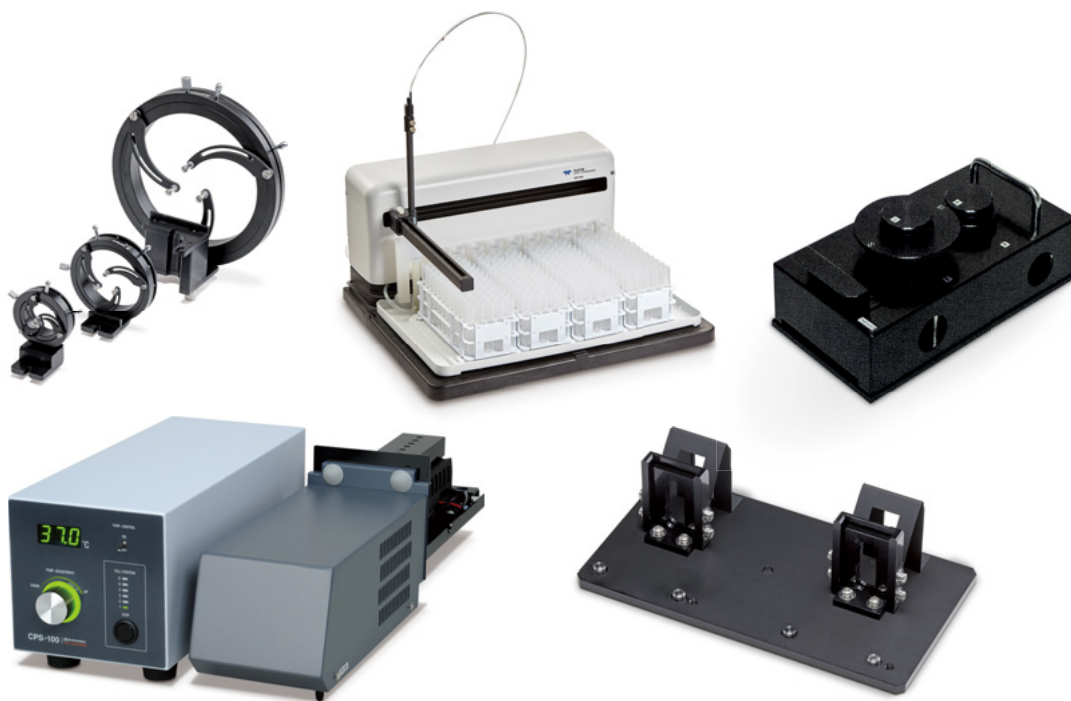

In order to make full use of the impressive functionality offered by UV-VIS-NIR spectrophotometers, optimal accessories must be selected based on the given application field or sample characteristics. Therefore, Shimadzu offers an extensive selection of accessories for a wide range of applications, from basic measurements such as transmittance, relative reflectance, and absolute reflectance to multianalyte and micro-volume sample measurements.

	Accessory		P/N	Compatible Instrument Model					Compatible Older Instrument Model*	Page	
				UV-1280 UVmini	UV-1800 UV-1900(i)	UV-2600(i) UV-2700(i)	UV-3600(i) Plus UV-3600	SolidSpec(i)			
Basic Measurement	Cells		See text	✓	✓	✓	✓	✓	(1)(2)(3)(4)(5)(6)	5	
	Film Holder		204-58909	✓	✓	✓	✓	✓	(1)(2)(3)(4)(5)(6)	6	
	Rotating Film Holder		206-28500-41		✓	✓	✓		(2)(3)(4)(5)		
	Didymium Filter		202-30242-09	✓	✓	✓	✓	✓	(1)(2)(3)(4)(5)(6)		
	Holmium Filter		202-30242-05	✓	✓	✓	✓	✓	(1)(2)(3)(4)(5)(6)		
	Four-Cell Sample Compartment Unit with Holder		206-23670-91	✓	✓	✓	✓		(1)(2)(3)(4) (6)	7	
	Multicell Sample Compartment (Six Cells)		206-69160-41		✓	✓	✓		(2)(3)(4)		
			206-60605-42	✓					(1) (6)		
	Sample Compartment Unit		206-60184-07	✓					(1) (6)		
	Cell Type Sample Holder		207-21637-41	✓	✓	✓	✓		(1)(2)(3)(4)(5)(6)		
Glass/Film Holder for Standard Sample Compartment		207-21573-41	✓	✓	✓	✓	✓	(2)(3)(4)(5)			
Simplified Near Infrared Light Measurement	PMT, R5108		206-29869-41			For 2700(i)		(4) (UV-2500 series only)	8		
Short Optical Path Measurement	Spacers for Short-Path Cells		1 mm	204-21473-03	✓	✓	✓	✓		(1)(2)(3)(4)(5)(6)	
			2 mm	204-21473-01	✓	✓	✓	✓		(1)(2)(3)(4)(5)(6)	
			5 mm	204-21473-02	✓	✓	✓	✓		(1)(2)(3)(4)(5)(6)	
Long Optical Path Measurement	Four-Cell Type Long-Path Rectangular Cell Holder		204-27208	✓	✓	✓	✓		(1)(2)(3)(4)(5)(6)		
	Reference-Side Long-Path Rectangular Cell Holder		204-28720	✓	✓	✓	✓		(1)(2)(3)(4)(5)(6)		
	Long-Path Rectangular Cell Holder		204-23118-01	✓	✓	✓	✓	✓	(1)(2)(3)(4)(5)(6)		
	Cylindrical Cell Holder		204-06216-02	✓	✓	✓	✓	✓	(1)(2)(3)(4)(5)(6)		
Micro-Volume Measurement	Super-Micro Cell Holder		206-14334		✓	✓	✓	✓	(2) (4)(5)(6)	10	
			206-14334-01	✓					(1)		
	Micro Cell Holder with Mask		204-06896	✓	✓	✓	✓	✓	(1)(2)(3)(4)(5)(6)		
	8/16 Series Micro Multi-Cell Holders and Cells		MMC-1600	206-23680-58		✓	✓	✓		(2)(3)(4)	
	8/16 Series Constant-Temperature Micro Multi-Cell Holders and Cells		MMC-1600C	206-23690-58		✓	✓	✓		(2)(3)(4)	
Micro Cell Mask for Standard Six-Cell Holder		206-66828		✓					(1) (6)		
Constant-Temperature Measurement	Constant-Temperature Cell Holder		202-30858-44	✓	✓	✓	✓		(1)(2)(3)(4) (6)	12	
	Constant-Temperature Four-Cell Holder		204-27206-02	✓	✓	✓	✓		(1)(2)(3)(4) (6)		
	Constant-Temperature Water Circulator		NTT-2200P **	208-97263	✓	✓	✓	✓			(1)(2)(3)(4)(5)(6)
	Six-Cell Thermoelectrically Temperature-Controlled Cell Positioner		CPS-100	206-29500-XX	✓	✓	✓	✓		(1)(2)(3)(4) (6)	13
	Thermoelectrically Temperature-Controlled Cell Holder		TCC-100	206-29510-XX	✓	✓	✓	✓		(1)(2)(3)(4) (6)	
	Thermoelectric Single Cell Holder		S-1700	206-23900-XX		✓	✓	✓		(2)(3)(4) (6)	
	Analysis System		TMSPC-8	206-24350-XX		✓	✓	✓		(2)(3)(4)	
Automatic Analysis	Sipper Units		160L	206-23790-51	✓	✓	✓	✓	(1)(2)(3)(4) (6)	15	
			160T	206-23790-52	✓	✓	✓	✓	(1)(2)(3)(4) (6)		
			160C	206-23790-53	✓	✓	✓	✓	(1)(2)(3)(4) (6)		
			160U	206-23790-54	✓	✓	✓	✓	(1)(2)(3)(4) (6)		
	Syringe Sippers		N	206-23890-51	✓	✓	✓	✓	(2)(3)(4)	16	
			CN	206-23890-52	✓	✓	✓	✓	(2)(3)(4)		
	Auto Samplers		ASX-560	211-94230-01		✓	✓	✓		16	
			ASX-280	211-94412		✓	✓	✓			
	Auto Sample Changer		ASC-5 **	206-23810-XX	✓	✓	✓	✓	(1)(2)(3)(4)(5)		
	Solenoid Valve (Fluoropolymer)			204-06599-01	✓	✓	✓	✓	(1)(2)(3)(4)(5)(6)		
	Sample Waste Unit		SWA-2	206-23820-58	✓	✓	✓	✓	(1)(2)(3)(4)(5)(6)		
	Micro Flow-Through Cell with Holder		10 mm	204-06222-40	✓	✓	✓	✓	(1)(2)(3)(4)(5)(6)	17	
			5 mm	204-06222-41	✓	✓	✓	✓	(1)(2)(3)(4)(5)(6)		
	Front Panel with Holes			204-27588-03	✓	✓	✓	✓	(1)(2)(3)(4) (6)		
Flow Cell for Liquid Chromatography			206-12852-41		✓	✓	✓	(2)(3)(4)(5)			
UV Automated System Connection Kits			206-80880-42	✓	✓	✓	✓	(2)(3)(4)			
Instrument Validation	Low-Pressure Mercury Lamp Unit		206-28300-58			✓					
Onsite Measurement	Crossflow Cell for Process Monitor System		206-53570-13			✓	✓	(4)	18		
	Optical Fiber Coupler		206-54175-41			✓	✓	(4)			

\* Compatible Older Instrument Model: (1) UV-1200 series (2) UV-1601/1601PC/1650PC (3) UV-1700 PharmaSpec (4) UV-2401PC/2501PC/2450/2550 (5) UV-3101/3101S/3101PC/3150 (6) MultiSpec-1500  
 For details about models older than those shown above or their compatibility, contact your Shimadzu sales representative.  
 \*\* Corresponding product is not sold in Europe since it is not a RoHS compliant product.



	Accessory	P/N	Compatible Instrument Model					Compatible Older Instrument Model*	Page	
			UV-1280 UVmini	UV-1800 UV-1900(i)	UV-2600(i) UV-2700(i)	UV-3600(i) Plus UV-3600	SolidSpec(i)			
Suspension and Opaque Sample Measurement	Specular Reflectance Attachment (5° Incident Angle)	206-14046-58	✓	✓	✓	✓	✓	(1)(2)(3)(4)(5)(6)	20	
	Integrating Sphere Attachments	ISR-2600	206-28400-58			✓				21
		ISR-2600Plus	206-28410-58			For UV-2600(i)				
		ISR-603	207-20100-58				For UV-3600(i) Plus			
		ISR-1503	207-20900-58				For UV-3600(i) Plus			22
	Multipurpose Large-Sample Compartments	ISR-1503F	207-21300-58				For UV-3600(i) Plus			
		MPC-2600A	207-23520-41			✓				
	MPC-603A	207-23550-41				For UV-3600(i) Plus			23	
	Powdered Sample Holder (for Integrating Sphere)	MPC-603A	207-23550-41				For UV-3600(i) Plus			
	Powdered Sample Holder (for Integrating Sphere)		206-89065-41			✓	✓	✓	(4)(5)	
	Micro Beam Lens Unit		206-22051-41			For UV-2600(i)	For UV-3600(i) Plus	✓		
	Micro Sample Holder		206-28055-41			For UV-2600(i)	For UV-3600(i) Plus	✓		
	Cylindrical Sample Holders	D25 mm	207-23559-41			For UV-2600(i)	For UV-3600(i) Plus	✓		
		D50 mm	207-23559-42			✓	✓	✓	(4)(5)	24
		D110 mm	207-23559-43			✓	✓	✓	(4)(5)	
	Absolute Specular Reflectance Attachments	ASR-3105	206-16817-58			✓	✓	✓	(4)(5)	
		ASR-3112	206-16100-58			✓	✓	✓	(4)(5)	
		ASR-3130	206-15001-58			✓	✓	✓	(4)(5)	
		ASR-3145	206-15002-58			✓	✓	✓	(4)(5)	
	Sample Base Plate Integrating Sphere Sets	BIS-3100	206-17059-58			✓	✓		(4)(5)	
		BIS-603	207-21100-58				For UV-3600(i) Plus			
		BIS-3700	206-20880-51					For 3700(i)		25
		BIS-3700DUV	206-20880-52					For 3700(i) DUV		
	Large Polarizer Set		206-15694-40			✓	✓	✓	(4)(5)	
	Polarizers	Type I	206-13236-41			✓	✓	✓	(4)(5)	
		Type II	206-13236-42			✓	✓	✓	(4)(5)	
Type III		206-13163-40			✓	✓	✓	(4)(5)		
Polarizer Adaptor Set		206-15693			✓	✓	✓	(4)(5)		
Variable Angle Measurement Unit	For MPC-2600A	207-23490-41			✓					
	For MPC-603A	207-23490-42				For UV-3600(i) Plus			26	
Special Accessories for SolidSpec-3700	Automatic X-Y Stage	206-20810-59					✓			
	Direct Detection Units	DDU	206-20264-51					For 3700(i)		
		DDU-DUV	206-20264-52					For 3700(i) DUV		
	Purge Box		206-21788-58					For 3700(i) DUV		
	Large Specular Reflectance Attachment (5° Incident Angle)		206-20570-58					✓		
	Variable Angle Measurement Unit	For 100V	207-23470-41					✓		
		For 230V	207-23470-42					✓		
Square Cell Holder for Integrating Sphere		206-22339-92					✓			
Printer, Interface, Cable	Screen Copy Printer	DPU-S445	207-23484-48	For UV-1280	✓					
	Analog Signal Output Interface		206-25233-91	For UV-1280	✓	✓				
	USB Interface Cable		088-50602-49	For UV-1280	✓					
Optional Program	Water Analysis Program	See text	For UV-1280						29	
Software	LabSolutions™ UV-Vis ***	207-24525-92		✓	✓	For UV-3600(i) Plus	✓ ****		30	
	LabSolutions DB/CS UV-Vis	See text		✓	✓	For UV-3600(i) Plus	✓ ****		32	
	Upgrade Kit to LabSolutions DB/CS UV-Vis	See text		✓	✓	For UV-3600(i) Plus	✓ ****			
	UV Performance Validation Software	See text		For UV-1900(i)	✓					
	VisEase™ Simple Control Application	207-26411-91	For UV-1280	For UV-1900(i)				(2)(3)(4)	34	
Tm Analysis Software	206-57476-91		✓	✓	✓		(2)(3)(4)			
LabSolutions UV-Vis Optional Software	Color Measurement	207-24528-91		✓	✓	✓	✓	(2) (4)(5)		
	Film Thickness Measurement	207-25804-91		✓	✓	✓	✓	(2) (4)(5)	35	
	UPF Measurement	207-25806-91		✓		✓	✓	(5)		
	Automatic Analysis	207-25807-91		✓	✓	For UV-3600(i) Plus				
Solar Transmittance Measurement	207-25805-91				For UV-3600(i) Plus	✓		36		
Optional Software for UVProbe	LabSolutions DB/CS Connection Kit for UVProbe	See text	UV-1280	✓	✓	✓		(2)(3)(4)(5)	37	

\*\*\* LabSolutions UV-Vis is included as standard in UV-i Selection (UV-1900i, UV-2600i, UV-2700i, UV-3600i Plus, SolidSpec-3700i/3700i DUV).  
 \*\*\*\* Measurement using the Automatic X-Y Stage is not supported.

## Guide to Selecting Accessories

### Solid Samples

Samples	Measurement Method and Conditions		Accessories	
Smooth Surface Samples*	Transmittance measurement	Less than 3 mm thick	Standard Sample Compartment + Film Holder, Cell Type Sample Holder, Glass/Film Holder for Standard Sample Compartment	
		More than 3 mm thick	Integrating Sphere Attachment (ISR-2600, ISR-2600Plus, ISR-603)	
		Requires a large integrating sphere (due to ISO compliance and other reasons).	Integrating Sphere Attachment, 150 mm Dia. (ISR-1503, ISR-1503F)	
		Large sample size (over 100 mm square)	Large-Sample Compartment (MPC-2600A/603A or SolidSpec-3700(i)) Glass Sample Holder for MPC series/SolidSpec	
	Reflectance measurement	Relative specular reflectance measurement	Normal measurement	Specular Reflectance Measurement Attachment (5° incident angle)
			Large sample size (over 100 mm square)	SolidSpec-3700(i) + Large Specular Reflectance Measurement Attachment (5° incident angle)
		Absolute specular reflectance measurement	5° incident angle measurement	Absolute Specular Reflectance Attachment (ASR-3105) (Requires a Large-Sample Compartment and BIS-3100/3700/603 Sample Base Plate Integrating Sphere Set separately.)
			12°/30°/45° incident angle measurement	Absolute Specular Reflectance Attachment (ASR-3112, ASR-3130, ASR-3145) (Requires a Large-Sample Compartment, BIS-3100/3700/603 Sample Base Plate Integrating Sphere Set, and polarizer assembly separately.)
			Variable incident angle measurement	Variable Angle Measurement Unit (Requires large-sample compartment and polarizer assembly separately.)
		Relative diffuse reflectance measurement	Normal measurement	Integrating Sphere Attachment (ISR-2600, ISR-2600Plus, ISR-603)
Requires a large integrating sphere (due to ISO compliance and other reasons).	Integrating Sphere Attachment, 150 mm Dia. (ISR-1503, ISR-1503F)			
Rough Surface Sample**	Transmittance measurement	Normal measurement	Integrating Sphere Attachment (ISR-2600, ISR-2600Plus, ISR-603)	
		Requires a large integrating sphere (due to ISO compliance and other reasons).	Integrating Sphere Attachment, 150 mm Dia. (ISR-1503, ISR-1503F)	
		Large sample size (over 100 mm square)	Large-Sample Compartment (MPC-2600A/603A, or SolidSpec-3700(i))	
	Reflectance measurement	Relative diffuse reflectance measurement	Normal measurement	Integrating Sphere Attachment (ISR-2600, ISR-2600Plus, ISR-603)
			Requires a large integrating sphere (due to ISO compliance and other reasons).	Integrating Sphere Attachment, 150 mm Dia. (ISR-1503, ISR-1503F)
			Large sample size (over 100 mm square)	Large-Sample Compartment (MPC-2600A/603A, or SolidSpec-3700(i))
		Absolute diffuse reflectance measurement	Consult your Shimadzu representative. (Depends on the sample. A method using conversion from the mirror reflectance, for instance, is available.)	
	Large sample size (over 100 mm square)			Large-Sample Compartment (MPC-2600A/603A, or SolidSpec-3700(i))
	Small sample size (below 5 mm square)			Micro Sample Holder + Micro Beam Lens Unit

\* Metals with a mirror-finished surface, mirrors, transparent acrylic and films, etc.

\*\* Paper, cloth, plastics, semi-transparent films, etc.

For color measurement, the Color Analysis Software or LabSolutions UV-Vis Color Measurement Software is required separately. For film thickness measurement, the Film Thickness Measurement Software is required separately.

### Liquid Samples

Samples	Measurement Method and Conditions		Accessories	
Transparent Samples	Sample volume: 2.5 mL min.		Standard Sample Compartment + 10 mm Cell	
	Micro-volume measurement	1 mL min.	Semi-Micro Cell + Micro Cell Holder with Mask	
		500 µL min.	Micro Cell + Micro Cell Holder with Mask	
		50 µL min.	Super-micro Cell + Super-micro Cell Holder	
		For automatically measuring samples in multiple cells	MMC-1600 8/16 Series Micro Multi-Cell Holders and Cells	
	Samples with high absorbance, but that are difficult to dilute (short optical path measurement)		Short-Path Cell (1, 2, 5 mm) + Spacer for Short-Path Cell	
	Samples with low absorbance, but that are difficult to concentrate (long optical path measurement)		Long-Path Cell (20, 30, 50, 100 mm) + Long-Path Rectangular Cell Holder	
	For automatically measuring samples in multiple cells	Normal measurement		Multi-Cell Sample Compartment (sample volume: 2.5 mL min.)
		Small sample volumes (50 µL min.)		MMC-1600 8/16 Series Micro Multi-Cell Holders and Cells
		Requires temperature control		CPS-100 Six-Cell Thermoelectrically Temperature-Controlled Cell Positioner (sample volume: 2.5 mL min.)
	For temperature-controlled measurements (constant-temperature measurement)	Temperature-controlled with water circulation		Constant-Temperature Cell Holder + NTT-2200P Constant-Temperature Water Circulator
		Thermoelectrically temperature controlled	Normal measurement	TCC-100 Thermoelectrically Temperature-Controlled Cell Holder
			For automatically measuring samples in multiple cells	CPS-100 Six-Cell Thermoelectrically Temperature-Controlled Cell Positioner
	Automatically supplies sample to flow cells (automatic analysis)	Requires temperature control (constant-temperature water circulation)		S-1700 Thermoelectric Single Cell Holder
		Temperature control not necessary		160C Sipper Unit + NTT-2200P
Requires accurate control of aspiration volume.		Requires temperature control (constant-temperature water circulation)	160L/160T/160U Sipper Unit (Select type based on liquid volume.)	
		Temperature control not necessary	Syringe Sipper CN + NTT-2200P (Select flow cell based on liquid volume.)	
For automating measurement of multiple samples		Syringe Sipper N (Select flow cell based on liquid volume.)		
Suspension Samples	Absorption measurement of suspension samples	Wavelength range: 240 nm min.	Sipper Unit or Syringe Sipper + ASC-5 Auto Sample Changer	
		For measuring UV region above 190 nm	Integrating Sphere Attachment (ISR-2600, ISR-2600Plus, ISR-603)	
	Turbidity measurement	Light transmitted light turbidity measurement (commonly used measurement method)	SolidSpec-3700(i) DUUV	
Integrating sphere turbidity measurement		10/50 mm Cell + Long-Path Rectangular Cell Holder (Optical path length of cell depends on test method.)		
		Integrating Sphere Attachment (ISR-2600, ISR-2600Plus, ISR-603)		

# Basic Measurement

The following accessories are required for measurements using all Shimadzu spectrophotometer models.

## Cells

Samples are placed in cells for measurement. The figure below shows the ten sample cell shapes. Generally, the rectangular cell with an optical path length of 10 mm is used. In cases when absorption is low, a cell with a longer optical path length is used, whereas when absorption is high, a cell with a shorter optical path length is used. The relationship between absorption strength (absorbance) and cell length is described below. By utilizing this formula, an appropriate optical path length can be determined.

$$\text{Absorbance (A)} = \epsilon \cdot C \cdot L$$

- $\epsilon$  : Absorption coefficient  
(a constant for given samples)
- C : Concentration of sample
- L : Optical path length

A square cell with a stopper is generally used to measure volatile liquid samples, and a microcell is used to measure a small-volume sample.

Sample cells are made of one of the materials listed below. The wavelength range for each type of material has been established as follows:

Quartz (S cells) : 190 to 2500 nm

Quartz (IR cells) : 230 to 3200 nm

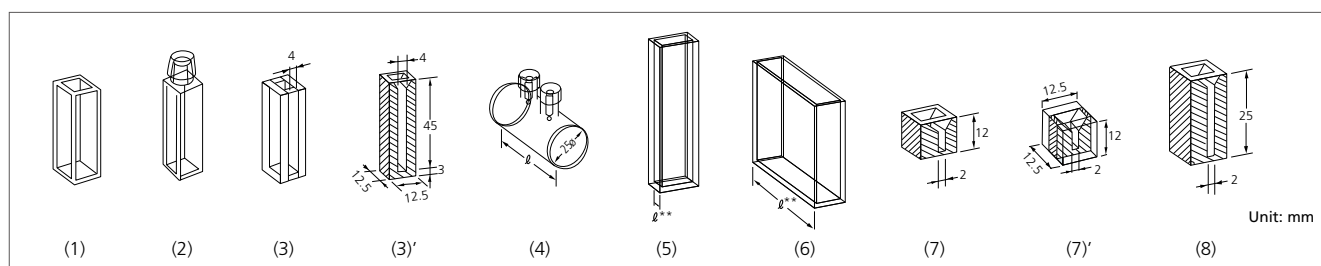

Description	Optical Path (L)	Required Sample Volume	Type	Quartz (S)	Quartz (IR)
Square Cell	10 mm	2.5 to 4.0 mL	(1) <sup>Note 1</sup>	200-34442	200-66579-01
	20 mm	5.0 to 8.0 mL	(6) <sup>Note 2</sup>	200-34446	200-66579-02
	50 mm	12.5 to 20.0 mL		200-34944	208-92327-03
	100 mm	25.0 to 40.0 mL		200-34676	208-92327-04
Square Cell with Stopper	10 mm	2.5 to 4.0 mL	(2)	200-34444	200-66579-21
Semi-Micro Cell	10 mm	1.0 to 1.6 mL	(3) <sup>Note 3</sup>	200-66501	200-66579-11
Semi-Micro Black Cell	10 mm	1.0 to 1.6 mL	(3)' <sup>Note 3</sup>	200-66551	200-66579-12
Super Micro Black Cell	5 mm	25 to 100 $\mu\text{L}^{-1}$	(7)' <sup>Note 4</sup>	208-92116	—
	10 mm	50 to 200 $\mu\text{L}^{-2}$	(7) <sup>Note 4</sup>	200-66578-11	—
Micro Black Cell	10 mm	50 to 400 $\mu\text{L}$	(8) <sup>Note 4</sup>	200-66578-12	—
Cylindrical Cell	10 mm	3.8 mL	(4) <sup>Note 5</sup>	200-34448	200-66579-31
	20 mm	7.6 mL		200-34472	200-66579-32
	50 mm	19.0 mL		200-34473-01	200-66579-33
	100 mm	38.0 mL		200-34473-02	200-66579-34
Short Path Cell	1 mm	0.3 to 0.4 mL	(5) <sup>Note 6</sup>	200-34660-01	200-66579-05
	2 mm	0.5 to 0.8 mL		200-34655	200-66579-06
	5 mm	1.3 to 2.0 mL		200-34449	200-66579-07

\*1 50 to 100  $\mu\text{L}$  for UV-1280 and UVmini series models.

\*2 100 to 200  $\mu\text{L}$  for UV-1280 and UVmini series models.

Note 1: If a cap is required for 10 mm square cells, purchase a cap (P/N 200-34565-02).

Note 2: The 100 mm cell cannot be used in UV-1280 and UVmini series models. The wide 100 mm cell can be used (see UV-1280 brochure).

Note 3: If used with a 5 nm or wider slit, a Micro Cell Holder with Mask (P/N 204-06896) is required. In UV-1280 or UVmini series models, a Micro Cell Mask for Six-Multicell Holder (P/N 206-66828) is required for measurements using a Multi-Cell Sample Compartment (P/N 206-60605-42), and a Micro Cell Holder with Mask (P/N 204-06896) is required for measurements using a Sample Compartment Unit (P/N 206-60184-07).

Note 4: Requires a Super-Micro Cell Holder (see page 10.) In UV-1280, UVmini series or MultiSpec-1500 models, a Sample Compartment Unit (P/N 206-60184-07) is also required.

Note 5: Requires Cylindrical Cell Holder (see page 9). In UV-1280, UVmini series or MultiSpec-1500 models, a Sample Compartment Unit (P/N 206-60184-07) is also required.

Note 6: Requires Spacers for Short-Path Cells (see page 8).

## Film Holder

(P/N 204-58909)

Holds thin samples, such as films and filters.

- Measurement sample size: Min. W 16 × H 32 mm  
Max. W 80 × H 40 × D 20 mm

Note 1: Sample Compartment Unit (P/N 206-60184-07) is necessary for the UV-1280, UVmini series, MultiSpec-1500.

Note 2: If used in a SolidSpec-3700(i) Spectrophotometer, then a Direct Detection Unit is required (see page 27).



## Rotating Film Holder

(P/N 206-28500-41)

This film holder enables in-plane rotation of samples centered on the optical axis.

It can be used to attach Polarizer Type I, II, or III.

Large Polarizer Sets cannot be used.

- Measurement sample size: W 33 × H 30 × D 2 mm

Note: For UV-1600/1700/1800/1900 series, Polarizer Type I and II only can be attached between the sample and the detector.

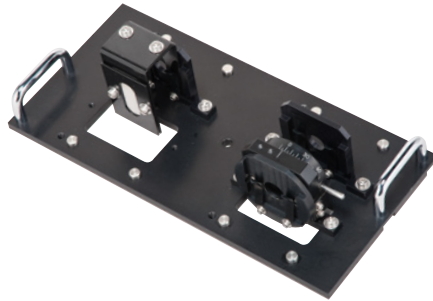

## Didymium Filter

(P/N 202-30242-09)

## Holmium Filter

(P/N 202-30242-05)

This can be used for simple operation check.

Note 1: Expert evidence, such as wavelength accuracy, is not included. Therefore, it cannot be used for performance verification and device management in accordance with applicable laws, regulations and standards.

Note 2: The spectrum shown is one example. The peak wavelength and other characteristics can vary depending on the lot.



Didymium Filter



Holmium Filter

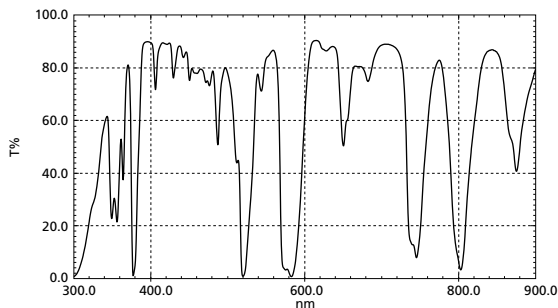

Spectrum Using a Didymium Filter

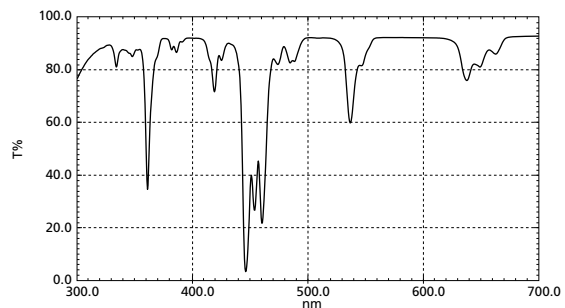

Spectrum Using a Holmium Filter



## Four-Cell Sample Compartment Unit with Holder

(P/N 206-23670-91)

Accommodates four-cell holders of various types.

Cell switching is manual.

- Includes a four-cell holder for 10-mm rectangular cells.

Note: Rectangular cells are not included. Purchase them separately.

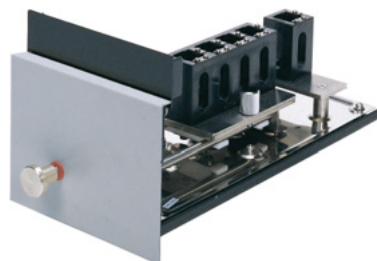

## Multicell Sample Compartment (Six Cells)

(See page 2 for part numbers)

Holds up to six 10 mm square cells. No temperature control capability.

Cell switching is automatic.

- Number of cells: Six on the sample side  
One on the reference side (No reference side for UV-1280 and UVmini series.)

Note: Rectangular cells are not included. Purchase them separately.

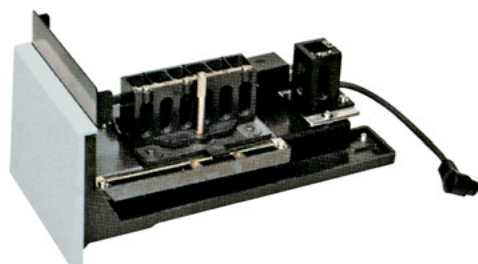

## Sample Compartment Unit

UV-1280, UVmini series, MultiSpec-1500 only (P/N 206-60184-07)

The Sample Compartment Unit is required for using other types of cells (such as a micro cell, micro flow-thru cell, long-path rectangular cell, cylindrical cell, film holder, or constant-temperature cell) in UV-1280, UVmini series, or MultiSpec-1500 models. Remove the standard cell holder and replace it with the sample compartment unit.



## Cell Type Sample Holder

(P/N 207-21637-41)

Holds 9 to 10 mm square samples and can be placed in a regular cell holder for measurements.



## Glass/Film Holder for Standard Sample Compartment

(P/N 207-21573-41)

Precisely holds 15 mm square glass samples for measurements.

A polarizer can also be held at the same time, so that polarized light from samples can be measured. It can also hold 30 to 50 mm square samples.



# Simplified Near Infrared Light Measurement

The wavelength measurement range can be extended to include the infrared region by using a photomultiplier tube compatible with near infrared light. That involves replacing the photomultiplier tube built in the main unit.

## PMT, R5108

UV-2700(i) only (P/N 206-29869-41)

- Measurement wavelength: 400 to 1,150 nm
- Noise: Approx. within  $\pm 2\%$

Note: Requires replacement by a qualified service engineer.

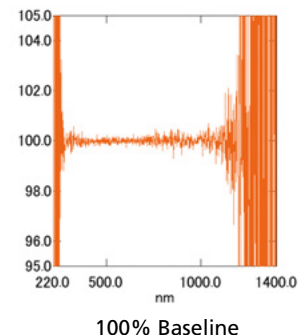

# Short Optical Path Measurement

Used to measure samples with absorbance too high to be measured with a standard 10 mm square cell.

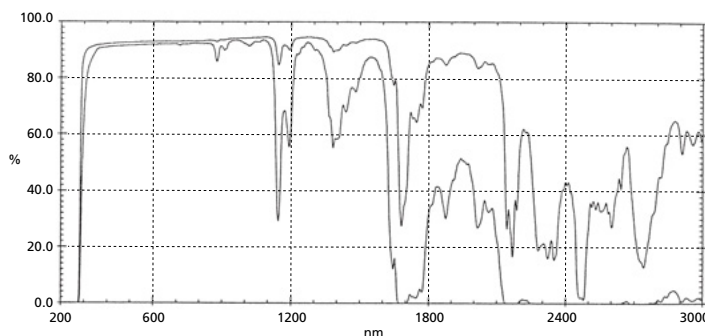

Absorption Spectra of Toluene (C<sub>6</sub>H<sub>5</sub>CH<sub>3</sub>) Measured Using a Cell with Either a 1 or 10 mm Optical Path Length

## Spacers for Short-Path Cells

The short-path cell can be used to measure concentrated samples without dilution, even if the sample is too concentrated to measure using the standard cell with a 10 mm optical path length.

As shown in the figure at right, the spacer is mounted in a standard rectangular cell holder in conjunction with a short-path cell.

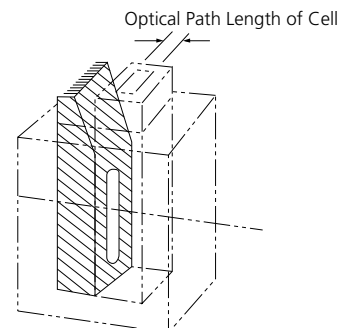

P/N (Spacer)	Optical Path Length of Cell
204-21473-03	1 mm
204-21473-01	2 mm
204-21473-02	5 mm



# Long Optical Path Measurement

When the concentration of a sample is too low to be measured using a standard 10 mm optical path length cell, a cell with a longer optical path length is used for measurement at the optimal absorption sensitivity. As shown in the figure on the right, the absorption spectrum of potassium permanganate becomes clearer when a 100 mm cell is used instead of a 10 mm cell.

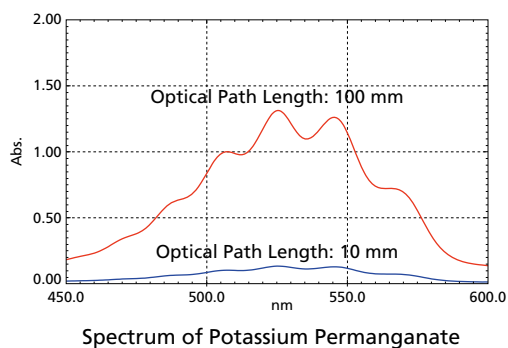

## Four-Cell Type Long-Path Rectangular Cell Holder

(P/N 204-27208)

Holds four rectangular cells: 10, 20, 30, 50, 70 and 100 mm in path length.

Note 1: The Four-Cell Sample Compartment (P/N 206-23670-91) is necessary.

Note 2: If the measurement requires a long rectangular cell at the reference side, a Reference Long-Path Rectangular Cell Holder (P/N 204-28720) is necessary.

Note 3: 70 mm and 100 mm cells cannot be used for UV-1280 and the UVmini series.

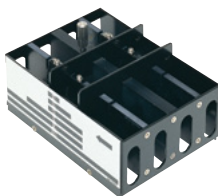

## Reference-Side Long-Path Rectangular Cell Holder

(P/N 204-28720)

If using a Four-Cell Type Long-Path Rectangular Cell Holder, use a reference-side cell holder as required.



## Long-Path Rectangular Cell Holder

(P/N 204-23118-01)

Holds two rectangular cells: 10, 20, 30, 50, 70 and 100 mm in path length.

Note 1: A Sample Compartment Unit (P/N 206-60184-07) is required if used in UV-1280, UVmini series, or MultiSpec-1500 models.

Note 2: 70 mm and 100 mm cells cannot be used in UV-1280 and UVmini series models. The wide type 100 mm cell and Long-Path Rectangular Cell Holder (for wide cells) can be used. (See UV-1280 brochure)



## Cylindrical Cell Holder

(P/N 204-06216-02)

Holds two cylindrical cells: 10, 20, 50 and 100 mm in path length.

Note: A Sample Compartment Unit (P/N 206-60184-07) is required if used in UV-1280, UVmini series, or MultiSpec-1500 models.



# Micro-Volume Measurement

The following accessories are used to measure micro-volume samples. This technique allows a sample size as small as 50  $\mu\text{L}$  to be measured using a super micro cell. Thus, this technique can be used for biochemical analysis in which minute samples are measured.

## Super-Micro Cell Holder

(See page 2 for part numbers.)

Accommodates super-micro cells for measurement of extremely small-volume samples. Using the adjustable cell height function, the sample volume can be adjusted between 25 and 200  $\mu\text{L}$ , depending on the type of black cell used.

- Applicable cells: Cells numbered (7), (7)', and (8) in the list of cells on page 5.
- Mask: W 1.5  $\times$  H 1 mm or W 1.5  $\times$  H 3 mm selectable
- One cell each can be placed on the sample and reference sides.

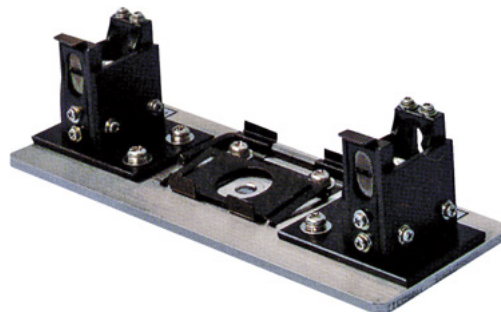
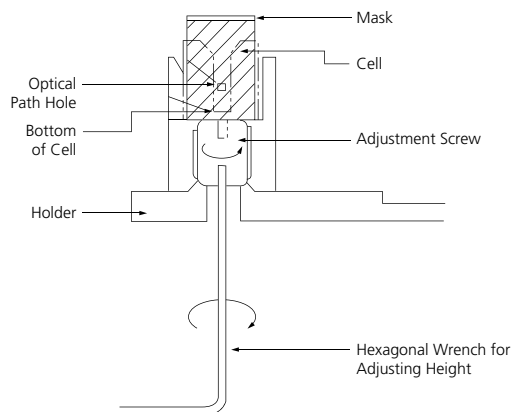

(P/N 206-14334)

Sample waste can be minimized due to the adjustable cell height design. Cell height can be optimized by turning the cell height adjustment screw from below, with the cell installed.

Note 1: A Sample Compartment Unit (P/N 206-60184-07) is required if used in UV-1280, UVmini series, or MultiSpec-1500 models.

Note 2: In UV-1280 or UVmini series models, use this holder with H 3mm Mask, and make the sample volume 60 $\mu\text{L}$  or more. (100 $\mu\text{L}$  or more when using 10mm optical path cell.)

Note 3: For UV-1700 models, use P/N 206-55050-91.

## Micro Cell Holder with Mask

(P/N 204-06896)

Required when using micro and semi-micro cells with an optical path width of less than 4 mm. (The mask width can be continuously adjusted.)

In UV-1280 and UVmini series models, this is required when using 4 mm optical path width semi-micro cells with a Sample Compartment Unit (P/N 206-60184-07). (It is not recommended to use cells with an optical path width of less than 4 mm in UV-1280 and UVmini series.)



## MMC-1600 8/16 Series Micro Multi-Cell Holders and Cells

(P/N 206-23680-58)

## MMC-1600C 8/16 Series Constant-Temperature Micro Multi-Cell Holders and Cells

(P/N 206-23690-58)

This cell holder holds one micro multi-cell, either 8 or 16 cell, for micro-volume measurement. Two micro multi-cell holders are available: a standard type (MMC-1600) and a constant temperature water circulation type (MMC-1600C).

Note 1: A Constant-Temperature Water Circulator is required when using the MMC-1600C.

Note 2: Choose one of the following micro multi-cells.

Micro Multi-Cells			
Standard Sample Volume	Optical Path (L)	Required Sample Volume	P/N
8 Series Micro Multi-cell	10 mm	100 µL	208-92089
16 Series Micro Multi-cell	10 mm	100 µL	208-92088
8 Series Micro Multi-cell	5 mm	50 µL	208-92086
16 Series Micro Multi-cell	5 mm	50 µL	208-92085

There are two types of micro multi-cells available in both the 8 Series and the 16 Series models: a 50 µL type and a 100 µL type. The cell intervals of the 8 Series Micro Multi-cell are applicable for use with 8 × 12 well microplates and 8-channel pipettes. Microplate samples aspirated into multi-channel pipettes can be injected directly into the cells for measurement.

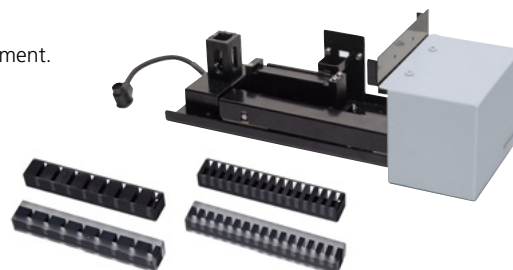

- Micro-volume samples can be measured (Minimum sample volume: 50 or 100 µL)
- Support for commercial microplates and micro pipettes (with 8 Series micro cell)
- Up to 16 samples can be measured at a time (with 16 Series micro cell)
- Operating temperature range: 10 to 60 °C (only for the constant-temperature water circulation type)
- Temperature difference between constant-temperature water and cell interior: 3 °C or less (only for the constant-temperature water circulation type)
- Temperature stabilization time: Max. 15 min (only for the constant-temperature water circulation type)
- Connecting Joint outer diameter: 6 mm and 9 mm (two levels) (only for the constant-temperature water circulation type)

## Micro Cell Mask for Six-Multicell Holder

UV-1280, UVmini series, MultiSpec-1500 only (P/N 206-66828)

This mask is used to narrow the flux width when 4 mm optical path width micro cells are placed in the Multicell Sample Compartment for measurement in UV-1280, UVmini series, or MultiSpec-1500 models.

- Applicable cell:
  - 10 mm Semi-micro cell (quartz) (P/N 200-66501)
  - 10 mm Semi-micro black cell (quartz) (P/N 200-66551)

Note: This cannot be used with a CPS-100 Cell Holder Positioner.



# Constant-Temperature Measurement

The following accessories are used for biological component measurement, enzymatic activity measurement and reaction rate analysis for which the sample temperature must be kept constant.

The figure shows an example of using a UV-2600 spectrophotometer combined with a CPS-100 Six-Cell Thermoelectrically Temperature-Controlled Cell Holder Positioner to measure the enzymatic activity of ALP.

This enzyme is used for enzymatic quantitation of lecithin during reactions between phospholipase C and choline oxidase. A high ALP value may indicate liver damage.

- Substrate : 0.1 mM
- Enzyme : 0 to 0.05 U
- Temperature : 37 °C
- Detection wavelength: 420 nm

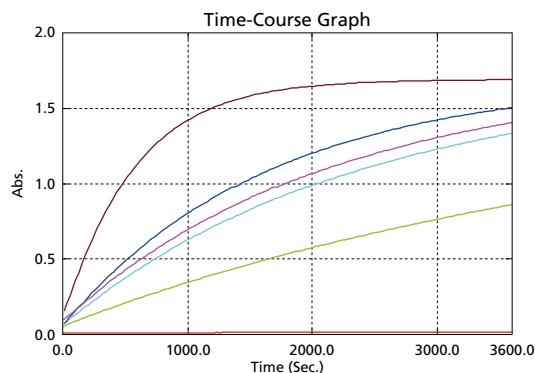

Example of Measuring Enzymatic Activity of ALP

## Constant-Temperature Cell Holder

(P/N 202-30858-44)

Maintain a sample cell and reference cell at a desired, uniform temperature by circulating constant-temperature water.

- Temperature range: 5 to 90 °C (depends on the performance of the constant-temperature water circulator)
- Accepts a pair of 10 mm square cells
- Connection joint outer diameter: 6 mm and 9 mm

Note 1: Sample Compartment Unit (P/N 206-60184-07) is necessary for the UV-1280, UVmini series, and MultiSpec-1500.

Note 2: Requires a Constant-Temperature Water Circulator.

Note 3: Stirrer installation is possible. Please contact us separately.

Note 4: Dry air can be supplied from the hole in the front plate to prevent condensation.

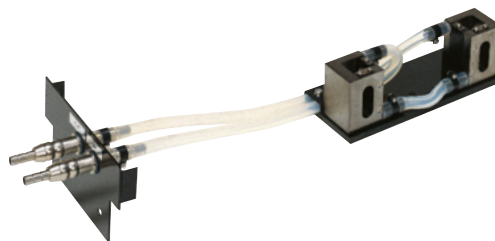

## Constant-Temperature Four-Cell Holder

(P/N 204-27206-02)

Maintain four sample cells and a reference cell at a desired, uniform temperature by circulating constant-temperature water.

Enables four samples to be placed simultaneously.

- Temperature range: 5 to 90 °C (depends on the performance of the constant-temperature water circulator)
- Accepts four 10 mm square cells plus a reference cell (Four cells can be placed on the sample side and one cell on the reference side.)
- Connection joint outer diameter: 9.5 mm

Note 1: The Four-Cell Sample Compartment (P/N 206-23670-91) is necessary.

Note 2: Requires a Constant-Temperature Water Circulator.



## NTT-2200P Constant-Temperature Water Circulator

(P/N 208-97263)

Circulates temperature-controlled water to a constant-temperature cell holder.

- Temperature range: (Ambient +15) °C to 80 °C
- Temperature control precision:  $\pm 0.05$  °C
- Max. pumping rate: 27/31 L/min, Max. lifting height 9.5/13 m (50/60 Hz)
- External circulation nozzle: 10.5 mm O.D. (both outlet and return)
- Tank capacity: About 10 L (9 L during use)
- Safety features: Detection of over-temperature of Upper or Lower limits, Detection of heater wire malfunction, Protection of heating too little circulating water, Detection of sensor malfunction, Independent over treat protection, Over current circuit protector
- Standard accessories: Lid with handles, Rubber hose (4 m, one tube with 8 mm I.D. and 12 mm O.D.), Hose clamps (4 pcs.), Instruction manual
- Dimensions: W 270 × H 560 × D 400 mm
- Power requirements: 100 VAC, 1250 VA, with 1.7 m power cord and grounded plug



Note 1: NTT-2200P is not sold in Europe since it is not a RoHS compliant product.

Note 2: Not adoptable to S-1700 nor TMSPC-8

## CPS-100 Six-Cell Thermoelectrically Temperature-Controlled Cell Positioner

(P/N 206-29500-XX)

These six-cell positioners permit measurement of up to six sample cells under constant-temperature conditions.

When used in the kinetics mode, a system can be configured to measure enzyme activity in up to six samples maintained at a constant temperature.

- Number of cells: Six on the sample side (temperature controlled)  
One on the reference side (temperature not controlled)
- Temperature range: 16 to 60 °C
- Temperature display accuracy (difference from the true value):  $\pm 0.5$  °C
- Temperature control precision (variation of temperature):  $\pm 0.1$  °C
- Ambient temperature: 15 to 35 °C



Note 1: Square cells are not included in the standard contents.

Note 2: A USB adaptor CPS (P/N 206-25234-91) is required when used in UV-1280, UV-1800/1850, UV-1900(i) or UV-2600(i)/2700(i) models. CPS cable ASSY (P/N 200-79883-01, CE model P/N 206-55625-41) is required for use with models other than those listed above.

Note 3: The Kinetics Program Pack (P/N 206-89756-92) cannot be used to simultaneously measure multiple samples in the UVmini-1240.

Note 4: The following power supply is required: 100 to 120 or 220 to 240 VAC, 50/60 Hz, 130 VA

## TCC-100 Thermoelectrically Temperature-Controlled Cell Holder

(P/N 206-29510-XX)

Uses Peltier effect for controlling the sample and reference temperature, so no thermostated bath or cooling water is required.

- Number of cells: One each on the sample and reference sides (temperature controlled)
- Temperature range: 7 to 60 °C
- Temperature display accuracy (difference from the true value):  $\pm 0.5$  °C
- Temperature control precision (variation of temperature):  $\pm 0.1$  °C

Note 1: Square cell (P/N 200-34442) not included. Needs to be purchased separately.

Note 2: Contact your Shimadzu representative if a stirrer is required.

Note 3: The following power supply is required: 100 to 120 or 220 to 240 V AC, 50/60 Hz, 130 VA



Note 4: To prevent the condensation on the surface of cell when covering measurement point under 10 °C, dry air supply to purge connector is required. The equipments below are necessary for purging.

Flow rate: Approx. 13 L/min (less than 15L/min)

Inner diameter of the connecting tubing: 4 mm

## S-1700 Thermoelectric Single Cell Holder

(P/N 206-23900-XX)

This cell holder permits setting of a temperature program to increase and decrease the sample cell temperature.

- The thermoelectric system allows prompt control of sample temperature between 0 °C and 110 °C.
- Temperature increase/decrease speed can be changed using 12 settings, which means the holder can be used in analysis of melting curves for nucleic acids, etc. that occur during quick as well as slow heating (or cooling).
- A stirrer is also provided to ensure uniform temperature distribution throughout the cell.
- Cooling water circulation is required for Peltier element cooling. Though tap water can be used, use of a consistent-temperature water circulator is highly recommended.
- Temperature is not controlled at the reference side.
- Cells are not supplied. Please use 10mm square tight-sealing cells (a Hellma product).

Type	Optical Path Length	Minimum Sample Volume Required
110-QS-10	10 mm	3.5 mL
115B-QS-10	10 mm	400 µL



- Temperature accuracy in cell (when room temperature is 25 °C)
  - Within ± 0.25 °C (0 to 25 °C)
  - Within ± 1% °C of set value (25 to 75 °C)
  - Within ± 2% °C of set value (75 to 110 °C)
- If the water temperature is high or low, it might be difficult to cool or warm to desired temperature. In addition, there is a risk of dew condensation or pipe clogging.

Note 1: Purchase a constant-temperature water circulator that satisfies the following specifications.

Cooling water temperature: 20 ± 2 °C; Flow rate: 4.8 L/min or more; Inner diameter of connecting tubing: 4 mm

Note 2: To prevent the condensation on the surface of cell when covering measurement point under 10 °C, Nitrogen gas (or dry air) supply to purge connector is required. The equipments below are necessary for purging.

Flow rate: Approx. 3 L/min (less than 5L/min)  
Inner diameter of the connecting tubing: 4 mm

Note 3: The following power supply is required: 100 to 120 or 220 to 240 V AC, 50/60 Hz, 110 VA

## TMSPC-8 Tm Analysis System

(P/N 206-24350-XX)

Using the Tm Analysis Software, temperature vs. absorbance graph data is uploaded to a computer to analyze the  $T_m$  (melting temperature) of nucleic acids (DNA and RNA) or other substances. The Tm Analysis System includes a thermoelectric 8-cell holder, Tm Analysis Software, and specialized controller. It does not include an 8 series micro cell, silicone cap, or constant-temperature water circulator for protecting the Peltier element. These must be purchased separately.

Model	P/N
8 Series Micro Cell, Optical Path: 10 mm, Sample Volume: 100 µL	208-92097-11
8 Series Micro Cell, Optical Path: 1 mm, Sample Volume: 35 µL	208-92140
Silicone Cap for Micro Cell (Set of 24)	206-57299-91

- Temperature control range: 0.0 to 110.0 °C
- Tm calculation mode: Average Method, Differential Method (Requires a separate computer equipped with an RS-232C port.)
- OS: Windows 10 Pro 64 bit edition, Windows 7 Professional 32/64 bit edition



### Applications

- Predicting the thermal stability and structure of nucleic acids
- Analyzing and optimizing hybridization
- Screening antisense and antigen sequences
- Validating targets using antisense and antigen methods

Note 1: Purchase a constant-temperature water circulator that satisfies the following specifications. Cooling water temperature: 20 ± 2 °C; Flow rate: 4.8 L/min or more; Inner diameter of connecting tubing: 4 mm

Note 2: To prevent the condensation on the surface of cell when covering measurement point under 10 °C, Nitrogen gas (or dry air) supply to purge connector is required. The equipments below are necessary for purging.

Flow rate: Approx. 3 L/min (less than 5L/min)  
Inner diameter of the connecting pipe: 4 mm

Note 3: The following power supply is required: 100 to 120 or 220 to 240 V AC, 50/60 Hz, 110 VA



# Automatic Analysis

The following accessories are used to continuously send samples to a sample compartment for measurement.

The sipper unit automatically supplies sample solutions in cells using a step motor-driven peristaltic pump. When this unit and the auto-sample changer are used simultaneously, up to 100 samples can be measured automatically in approximately 20 minutes. The micro flow cell can also be used for continuous measurement of the column effluent.

## Sipper Units

Four types of sipper units with different cell types are available. The stepping motor-driven peristaltic pump ensures reliable and smooth aspiration of sample solution.

(It can be driven directly from the UV-unit so no interface is required.)

Note: The use of a Solenoid Valve (P/N 204-06599-01) and the SWA-2 Sample Waste Unit (P/N 206-23820-58) are recommended when strong acids, strong alkalis, or organic solvents are to be measured.

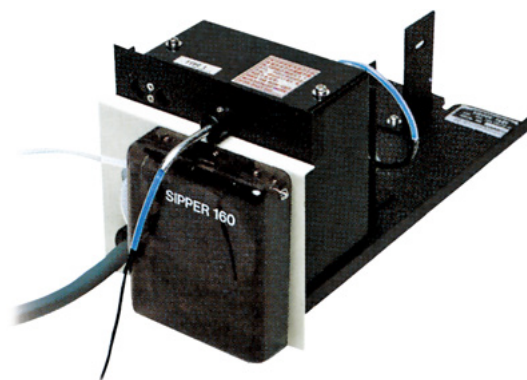

## Type and Configuration of Flow Cells

160L (P/N 206-23790-51)	160T (P/N 206-23790-52)	160C (P/N 206-23790-53)	160U (P/N 206-23790-54)
<p>Cross-Section of a L-Type Flow Cell Standard Type (Required Sample Volume: 2.0 mL)</p>	<p>Cross-Section of a T-Type Flow Cell Triple-Pass Type (Required Sample Volume: 1.5 mL)</p>	<p>Cross-Section of a C-Type Flow Cell Constant-Temperature Type (Required Sample Volume: 2.5 mL)</p>	<p>Cross-Section of a U-Type Flow Cell Super-Micro Type (Required Sample Volume: 0.5 mL)</p>

- Model 160L uses the standard flow cell, which is L-shaped.
- Model 160T uses a triple-pass flow cell. Due to the long narrow roughly-straight shape of the flow cell, samples flow smoothly into and out of the cell, which minimizes contamination and the formation of bubbles, even with samples prone to bubbles.
- Model 160C uses a constant-temperature type flow cell. Due to the double-walled structure of the flow cell, constant-temperature water can be circulated around the flow cell to ensure more accurate and efficient constant-temperature measurements.
- Model 160U is for micro volumes. It enables measurement of smaller quantities, with lower carryover levels, than other flow cells.

## Syringe Sippers

**N** (P/N 206-23890-51)

**CN** (P/N 206-23890-52)

Two types of syringe sippers are available: the normal-temperature type (N) and the constant-temperature, water-circulating type (CN). The sipper unit employs a syringe pump system. The liquid contact surfaces are composed of PTFE, glass, or quartz, imparting excellent chemical resistance and ease of maintenance, and allowing measurement of almost any sample type. Further, the extremely high repeatability of sipping volume (repeat precision:  $\pm 0.03$  mL) makes it ideal when performance validation is required.

Flow cell available separately. Choose from the recommended flow cells listed below.

Recommended Flow Cells				
Cell Type	P/N	Optical Path Length	Dimensions of Aperture	Standard Required Sample Volume
Square (Ultra-micro)	208-92114	10 mm	$\phi 2$ mm	0.9 mL
Square (Micro)	208-92113	10 mm	$\phi 3$ mm	1.0 mL
Square (Semi-micro)	208-92005	10 mm	H11 x W3.5 mm	5.0 mL



- The ability to replace only the flow cell provides easier maintenance.
- Temperature range of circulating water: room temperature to 60 °C (CN type)

Note 1: If a rectangular flow cell (micro or super-micro) is used, attaching Mask R (P/N 206-88679) to the reference cell holder is recommended to balance the light intensity.

Note 2: The Sample Compartment Unit (P/N 206-60184-07) is necessary for UV-1280 and the UVmini series. Square cell (Ultra-micro) cannot be used for UV-1280 and the UVmini series.

Note 3: Inner diameter of the constant-temperature water connecting tubing: 4 mm or 12 to 16 mm (CN type only)

## ASX-560/280 Autosampler

In combination with a Sipper unit or Syringe Sipper unit, a multi-sample automatic measurement system for solution samples can be configured.

Model	P/N	Number of vials
ASX-560	211-94230-01	240
ASX-280	211-94412	120

Note 1: CETAC Connect Kit (P/N 207-26525-41) and LabSolutions UV-Vis Automatic Analysis Software (P/N 207-25807-91) is required.

Note 2: These are available in UV-1800/1900(i)/2600(i)/2700(i)/3600(i) Plus.



ASX-560

## ASC-5 Auto Sample Changer

(P/N 206-23810-XX)

If the ASC-5 is combined with a sipper unit or syringe sipper, it is possible to configure an automated multisample spectrophotometry system for liquid samples.

- It is equipped with an accurate X–Y–Z 3-axis movement mechanism.
- Up to eight sets of parameters, such as rack size and number of test tubes, can be memorized in the battery back-up protected files.
- Up to 100 test tubes can be placed on the rack.

Note 1: Supports using commercially available test tube stands with a footprint smaller than 220 x 220 mm.

Note 2: A USB adaptor ASC (P/N 206-25235-91) is required when used in UV-1280, UV-1800/1850, UV-1900(i) or UV-2600(i)/2700(i) models. ASC cable ASSY (P/N 200-79031-01) is required for use with models other than those listed above.

Note 3: Cannot be used in the SolidSpec-3700(i)/3700(i) DUV.

Note 4: The following power supply is required: 100 to 120 or 200 to 240 V AC, 50/60 Hz, 66 VA

Note 5: ASC-5 is not sold in Europe since it is not a RoHS compliant product.



## Solenoid Valve (Fluoropolymer)

(P/N 204-06599-01)

This accessory is required for strong acid, strong alkaline, and ester solutions, due to the lack of chemical resistance in peristaltic pumps used in sipper units. It also requires an SWA-2 Sample Waste Unit (P/N 206-23820-58).

## SWA-2 Sample Waste Unit

(P/N 206-23820-58)

The SWA-2 is a convenient unit for sample suction and disposal that can be used in place of an aspirator.

- Built-in suction pump
- Size: W 280 × D 300 × H 450 mm (up to upper edge of gauge)
- Power requirements: 100 V AC, 50/60 Hz, 20 VA

Note: Use this unit instead of aspirators at sites where water pressure can vary, due to potential variability in sample suction volumes.



## Micro Flow-Through Cell with Holder

Used for the continuous analysis of samples such as the liquids produced by column chromatography.

- Tubing I.D.: 1 or 2 mm

Note: Sample Compartment Unit (P/N 206-60184-07) is necessary for the UV-1280, UVmini series, and MultiSpec-1500.

Description	P/N	Optical Path Length	Cell Volume
10 mm Micro Flow-Through Cell with Holder	204-06222-40	10 mm	0.3 mL
5 mm Micro Flow-Through Cell with Holder	204-06222-41	5 mm	0.15 mL



## Front Panel with Holes

(P/N 204-27588-03)

Allows the tubes of a flow-through cell, for example, to be connected through the front panel of the instrument.

Note: Sample Compartment Unit (P/N 206-60184-07) is necessary for the UV-1280, UVmini series, and MultiSpec-1500.



## Flow Cell for Liquid Chromatography

(P/N 206-12852-41)

This flow cell allows UV-VIS detection for high performance liquid chromatography at variable wavelengths.

- Inner diameter: 1 mm, optical path length: 10 mm, volume: 8  $\mu$ L
- Sample side: flow cell, reference side: cell holder with mask
- Stainless steel tubing: 1.6 mm O.D. and 0.3 mm I.D.

Note 1: Not applicable to UV-1280, UVmini series, SolidSpec-3700(i)/3700(i) DUV.

Note 2: For UV-1800/1900(i)/2600(i)/2700(i), when connecting an integrator, analog signal output interface (P/N 206-25233-91) is required.

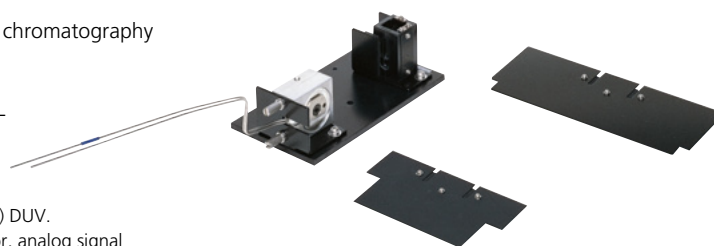

## UV Automated System Connection Kits

(P/N 206-80880-42)

Enables connection to a Gilson GX-271 liquid handler. The liquid handler performs a variety of pretreatments automatically, including sample dispensing and dilution, and the addition of reagents. This connection kit interfaces the spectrophotometer and the liquid handler.

- The connection kit consists of a flow cell unit and connection cable. The liquid handler is not included.

Note 1: A Sample Compartment Unit (P/N 206-60184-07) is required for use in UV-1280 and UVmini series models.

Note 2: Cannot be used in the SolidSpec-3700(i)/3700(i) DUV.

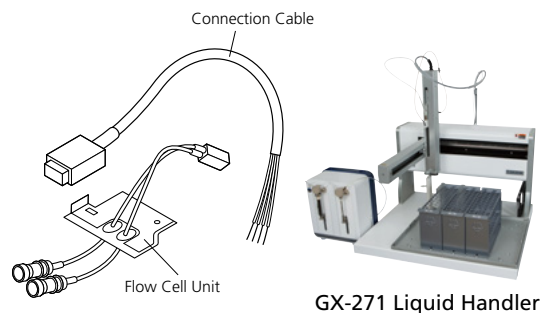

GX-271 Liquid Handler

# Instrument Validation

## Low-Pressure Mercury Lamp Unit

UV-2600(i)/2700(i) only (P/N 206-28300-58)

This unit is used to attach a low-pressure mercury lamp in the light source chamber in the main unit for confirming wavelength accuracy. It can be used in conjunction with the validation software included with the main unit.

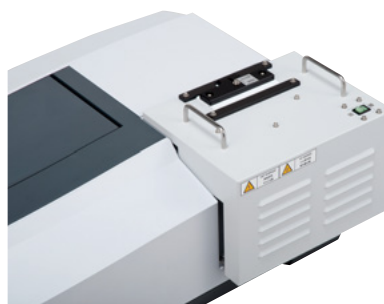

# Onsite Measurement (Optical Fiber Application Measurement)

## Crossflow Cell for Process Monitor System

UV-2600(i)/2700(i) series, UV-3600/3600(i) Plus only (P/N 206-53570-13)

Optical path length is continuously variable from 1 mm to 15 mm to allow monitoring of samples of any concentration.

This cell can be used for applications such as monitoring reaction processes or controlling the concentration of rinse solutions or liquid waste.

It uses a single 600 μm diameter fiber to achieve high throughput.

General-purpose SMA905 connectors are used to connect optical fibers.

- Measuring wavelength range: 230 to 800 nm (for 2 m fiber length)
- Optical path length: 1 to 15 mm (variable)
- Sample temperature: <130 °C
- Pressure resistance: <1.72 MPa (17.6 kg/cm<sup>2</sup>)
- Material: 316SS
- Pipe connectors: 1/2 inch
- Optical material: synthetic quartz



Exterior of Crossflow Cell

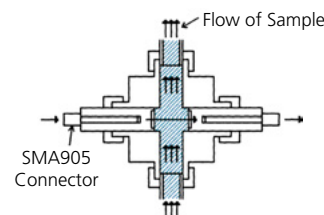

Structure of Crossflow Cell

## Optical Fiber Coupler

UV-2600(i)/2700(i), UV-3600/3600(i) Plus only (P/N 206-54175-41)

An optical fiber application system is connected to a UV-VIS spectrophotometer using a high-precision optical fiber coupler. This optical fiber coupler has been designed for the UV-2600(i)/2700(i) and UV-3600/3600(i) Plus to guarantee high throughput and stability.

Note 1: If fibers are connected, the spectrophotometer basic specifications for measuring accuracy, stray light, etc. are out of guarantee.

Note 2: Crossflow cell is designed to have maximum throughput at room temperature.

Crossflow cells are intended for liquids. They are not used for gases.

Note 3: Intensity available for transmission decreases according to the fiber length by approximately the following ratios.

### Configurations

Description	P/N	Process Monitor System
UV-2600/2600i	—	Choose among these
UV-2700/2700i	—	
UV-3600/3600 Plus/3600i Plus	—	
Crossflow Cell <sup>Note 2</sup>	206-53570-13	✓
Optical Fiber Coupler (with two 0.5 mm optical fibers)	206-54175-41	✓
Optical Fiber, 2 m (set of 2) <sup>Note 3</sup>	206-53875-92	Optional
Optical Fiber, 5 m (set of 2) <sup>Note 3</sup>	206-53875-93	
10m optical fibers (2 pcs. a set) <sup>Note 3</sup>	206-53875-94	
20m optical fibers (2 pcs. a set) <sup>Note 3</sup>	206-53875-95	

Fiber Length	Decrease in UV Range (100% at 0.5 m)	Decrease in Visible Range (100% at 0.5 m)
2 m	80%	95%
5 m	60%	92%
10 m	36%	90%
20 m	13%	80%

# Suspension and Opaque Sample Measurement

Measurement of suspension samples is difficult due to the scattering of reflected light by fine particles in the solution. Integrating spheres are used in this type of analysis. The glass method involves the placement of a scattering board behind the sample, resulting in the equalization of scattering coefficients of the reference side and sample side. As shown in Figure 1, the integrating sphere method involves a barium sulfate-coated sphere that draws the scattered light, allowing all of the light to reach the detector. Since light cannot penetrate opaque samples, it is reflected on the surface of the samples. Figure 2 shows one case in which incoming light is reflected symmetrically with respect to the normal line (forward reaction), and another case in which the incoming light is scattered in different directions. The former is referred to as specular reflection and the latter is referred to as diffuse reflection.

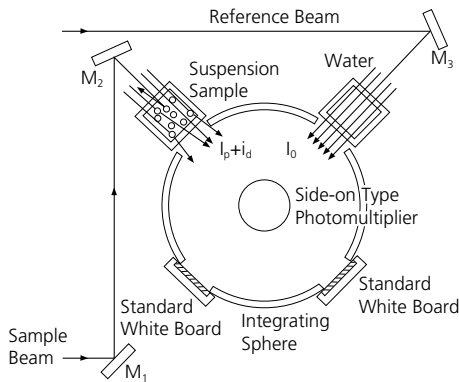

Figure 1. Semi-Transparent Sample Measurement Using the Integrating Sphere Method

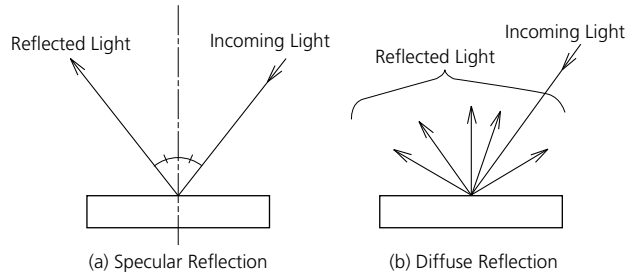

Figure 2. Specular Reflection and Diffuse Reflection

## Integrating Sphere Attachments

With this instrument, a turbid sample is placed in front of the incoming light window as shown in Figure 1, and the reflectance of an opaque sample is measured by placing it as shown in Figure 3. In this case, when light is directed at the sample at 0 degrees, diffuse reflectance is measured, and when light is directed at 8 degrees, total reflectance (specular and diffuse reflectance) can be measured.

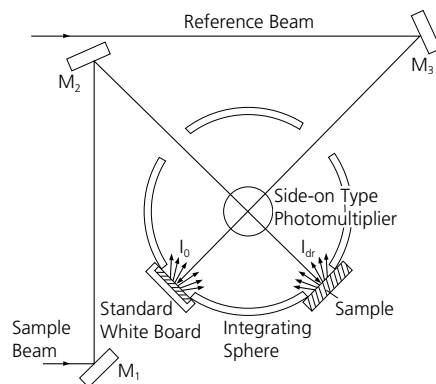
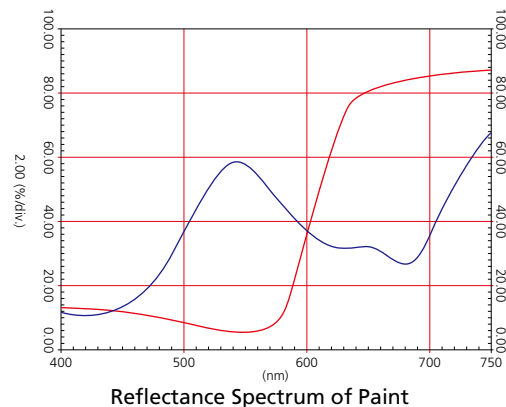
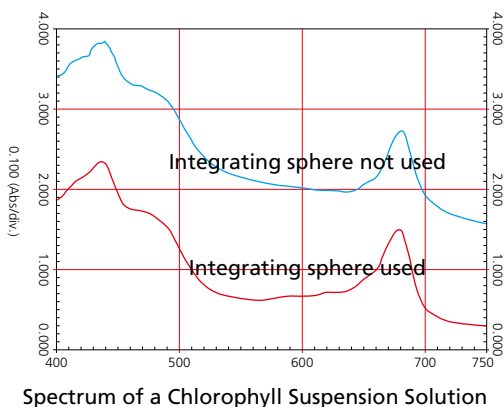

Figure 3. Opaque Sample Measurement Using the Integrating Sphere Method



## Specular Reflectance Attachment (5° Incident Angle)

(P/N 206-14046-58)

This attachment is used to measure the relative reflectance of specular reflected light, as indicated in Figure 2 (page 19). Relative specular reflectance is measured to determine reflectance based on the intensity ratio of reflected light from a reference sample versus the measurement sample. In other words, assuming a reflectance of 100% for the reference sample, it is used to determine the reflectance of a sample relative to the reference sample. The technique of specular reflectance measurement is often applied to the evaluation of semiconductors and optical materials. Because the properties of polarized light present almost no problems at a 5° incident angle, measurements can be performed easily without polarizers.

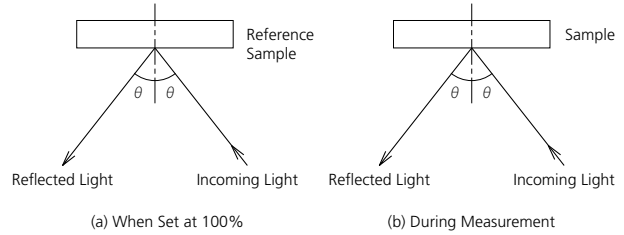

Relative Specular Reflectance Measurement

- Samples as large as W 100 × H 160 × D 15 mm can be readily measured with the UV-1280, UVmini series, UV-1600/1700/1800/1900(i), UV-2600(i)/2700(i), Solidspec-3700(i)/3700(i) DUV, and MultiSpec-1500. Samples as large as W 140 × H 160 × D 10 mm can be readily measured with the UV-2400/2500 series and UV-3600/3600(i) Plus. Minimum sample size is 7 mm dia (when using 5 mm dia. aperture).
- Sample placement is easy — just set it on the holder with the measuring surface down.



Note 1: The Sample Compartment Unit (P/N 206-60184-07) is necessary for the UV-1280, UVmini series, UV-1200 series, and MultiSpec-1500.

Note 2: Direct Detection Unit (see page 27) is necessary for the Solidspec-3700(i)/3700(i) DUV.

### Integrating Sphere Attachment List

		ISR-2600	ISR-2600Plus	MPC-2600A	ISR-603	MPC-603A	ISR-1503	ISR-1503F	
P/N		206-28400-58	206-28410-58	207-23520-41	207-20100-58	207-23550-41	207-20900-58	207-21300-58	
Spectrophotometer models supported		UV-2600(i)/2700(i)	UV-2600(i)	UV-2600(i)/2700(i)	UV-3600(i) Plus				
Inside diameter of integrating sphere		60 mm dia.						150 mm dia.	
Aperture ratio	During transmittance measurement	5.6%	7.4%	7.7%	7.2%		2.9%		
	During reflectance measurement	7.5%	9.3%	10%	9.7%		4.0%		
Integrating sphere interior wall material		BaSO <sub>4</sub>						Spectralon	
Incident light angle	Sample light	0 deg.						8 deg.	
	Reference light	8 deg.						0 deg.	
Detector		PMT	PMT InGaAs		PMT InGaAs PbS				
Wavelength range		220 to 850 nm	220 to 1400 nm		220 to 2600 nm		200 to 2500 nm		
Max. sample size for reflectance measurements	Sample light	W95 × H135 × T20		204 dia. × T50	W70 × H70 × T20	204 dia. × T50	W235 × H260 × T10		
	Reference light	W70 × H70 × T12		305 dia. × T5	W70 × H70 × T12	305 dia. × T5	W150 × H165 × T10	W150 × H165 × T5	
Max. sample size for transmittance measurements	Sample light	W50 × H60 × T5		305 dia. × T300*	W50 × H60 × T5	305 dia. × T300*	—		
	Reference light	W70 × H60 × T5		W50 × H60 × T15	W70 × H60 × T5	W50 × H60 × T15	W176 × H168 × T20		
Switching between sample/reference light		Yes							
Total, diffuse, or specular reflectance measurement		Yes							
Transmittance measurement		Yes							
Standard Accessories									
Standard white plate (BaSO <sub>4</sub> )		Yes							
Cell holder with 10 mm optical path length		Yes					No		
Film holder		Yes					Sold separately		
Powder sample reflectance measurement		Yes**					Sold separately		
Beam aperture mask for sample light		Yes (2 × 3 mm transmittance, 3 × 3 mm reflectance)		Yes (1 mm dia. sold separately)	No	Yes (1 mm dia. sold separately)	No		
Accessories Sold Separately									
Small sample holder		Yes			No	Yes	Yes (Transmittance only)		
Small beam aperture unit		No	Yes	No	Yes	No			
Cylindrical Sample Holder		No	Yes (5 to 110 mm dia.)		No	Yes (5 to 110 mm dia.)		Yes	
Manual V-stage		No	Yes	No	Yes	No			

\*: use V-stage (sold separately)

\*\* : About micro model, please contact us separately.



## ISR-2600 Integrating Sphere Attachment UV-2600(i)/2700(i) only (P/N 206-28400-58)

## ISR-2600Plus Integrating Sphere Attachment UV-2600(i) only (P/N 206-28410-58)

In combination with a 0° or 8° incident angle integrating sphere and S/R exchange functionality of the spectrophotometer, either diffuse or specular reflectance can be measured without using any special attachments. The ability to change the size of the flux in the reflectance measurement unit enables measuring reflectance at micro areas of samples (minimum flux size of about 2 × 3 mm). The flux size can also be narrowed to about 3 × 3 mm in the transmittance measurement unit.

The ISR-2600Plus Integrating Sphere Attachment includes two detectors: a photomultiplier tube and InGaAs detector.

### ISR-2600/2600Plus Common Specifications

- Integrating sphere I.D.: 60 mm
- Maximum size of reflectance sample: W 70 × H 70 × D 20 mm (0° incident angle)  
W 70 × H 70 × D 12 mm (8° incident angle)

### ISR-2600 Specifications

- Wavelength range: 220 to 850 nm
- Noise level: 0.1%T RMS 500 nm (UV-2600(i)), 0.3%T RMS 500 nm (UV-2700(i))
- 100% flatness: ± 0.5%T (UV-2600(i)), ± 1.5%T (UV-2700(i))

### ISR-2600Plus Specifications

- Wavelength range: 220 to 1400 nm
- Noise level: 0.1%T RMS 500 nm, 0.3%T RMS 900 nm
- 100% flatness: ± 0.5%T (220 to 1300 nm)
- NIR stray light: 0.4%T (typical value given 1400 nm, H<sub>2</sub>O, and 5 nm slit)

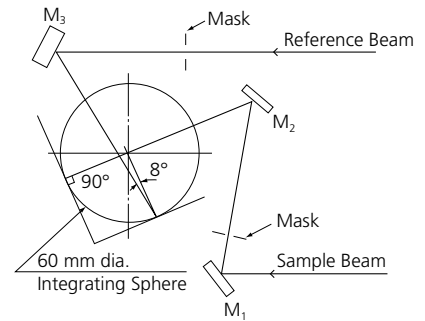

## ISR-603 Integrating Sphere Attachment

UV-3600(i) Plus only (P/N 207-20100-58)

- Wavelength range: 220 to 2600 nm
- Integrating sphere I.D.: 60 mm
- Detectors: PMT, PMT, InGaAs, PbS
- Reflectance sample size: Approx. 100 mm dia. x 15 mm<sup>t</sup>
- Incident light angle: 0°/8°
- Transmittance sample cell holder: Includes a holder for 10 mm rectangular cell (does not include cells), two BaSO<sub>4</sub> standard white plates, and two plates for powdered samples.



ISR-603

## 150 mm Dia. Integrating Sphere Attachments

**ISR-1503 (BaSO<sub>4</sub>)** UV-3600(i) Plus only (P/N 207-20900-58)

**ISR-1503F (PTFE)** UV-3600(i) Plus only (P/N 207-21300-58)

Used to measure the reflectance spectra of solid samples, such as powders, paper, or fabrics, or the transmittance spectra of liquid or solid samples. It enables reliable measurements unaffected by factors such as the sample surface status. Also, low-noise near infrared region measurements can be obtained by using a Spectralon ISR-1503F attachment.

- Wavelength range: 200 to 2500 nm
- Integrating sphere I.D.: 150 mm
- Detectors: PMT, InGaAs, PbS



- Sample placement orientation: Lateral for transmittance and 0° reflectance, Vertical for 8° reflectance
- Incident light angle: 0° or 8°
- Opening rate: 4.0% (0° reflectance), 4.0% (8° reflectance), or 2.9% (transmittance)

## Accessories for ISR-1503/1503F 150 mm Dia. Integrating Sphere Attachments

### Transmittance Small Sample Holder

ISR-1503 only (P/N 207-21742-41)

ISR-1503F only (P/N 207-21742-42)

This small sample holder is used for 0° transmittance measurement.

Flux size: 4 mm diameter

Sample size: 10 mm diameter min.



### Cuvette Cell Holder for Direct Detection

(P/N 207-21741-41)

This replaces the included optical system for measuring samples in 10 mm rectangular cells.



### Rear Cover with Window

(P/N 207-21858-41)

Used in combination with a Cuvette Cell Holder for Direct Detection. If installed in place of the normal ISR-1503/1503F rear cover, it enables easy exchange of samples by simply opening a window.

### Powdered Sample Holder

ISR-1503 only (P/N 207-21815-41)

ISR-1503F only (P/N 207-21815-42)

This holder is for measuring the reflectance of compressed powdered samples.

It is installed in the position for measuring 0° or 8° reflectance.



### Film Holder

ISR-1503 only (P/N 207-21743-41)

ISR-1503F only (P/N 207-21743-42)

This film holder is used for 0° transmittance measurement. It can secure film samples up to 50 x 50 mm.



### Hanging Sample Holder

ISR-1503 only (P/N 207-21750-41)

ISR-1503F only (P/N 207-21750-42)

Place the sample in the integrating sphere and measure the absorption rate. The measurement error increases if the sample has diffuse reflection and diffuse transmission components. Square cells are not allowed.

### Standard White Plate

This standard white plate is used to measure reflectance. They are available made of either BaSO<sub>4</sub> or Spectralon.

Material	P/N	
BaSO <sub>4</sub>	207-21744-41	For ISR-1503
	207-21744-44	For ISR-1503F
Spectralon	207-21744-43	For ISR-1503
	207-21744-42	For ISR-1503F

### Sample Holder

ISR-1503 only (P/N 207-21868-41)

ISR-1503F only (P/N 207-21868-42)

Though samples up to 100 g can be secured for 8° reflectance measurements, this holder is used to hold samples with a low coefficient of friction more securely.

## Multipurpose Large-Sample Compartments

**MPC-2600A** UV-2600(i)/2700(i) only (P/N 207-23520)

**MPC-603A** UV-3600(i) Plus only (207-23550-41)

These multipurpose large sample compartments can be used freely to measure the transmittance or reflectance of variously shaped samples. A built-in integrating sphere ensures that solid samples can be measured accurately. Due to the ample sample space around the integrating sphere, they can also be used for extra-large samples.

- Wavelength range: 220 to 1400 nm (MPC-2600A)  
Note: 220 to 850 nm when using with UV-2700(i)  
220 to 2600 nm (MPC-603A)
  - Maximum sample size:  
305 mm dia. × 50 mm<sup>t</sup> or 204 mm dia. × 300 mm<sup>t</sup> for transmittance samples  
305 mm dia. × 50 mm<sup>t</sup> for reflectance samples
  - The S/R exchange function enables reflectance measurements at zero or 8° incident angle without tilting the sample.
  - Sample positions can be adjusted back and forth or up and down with the use of V-stage.
- V-stage for MPC-2600A and MPC-603A need to be purchased separately.
- MPC-2600A and MPC-603A models can be changed easily to a variable angle attachment or other detector.



MPC-603A

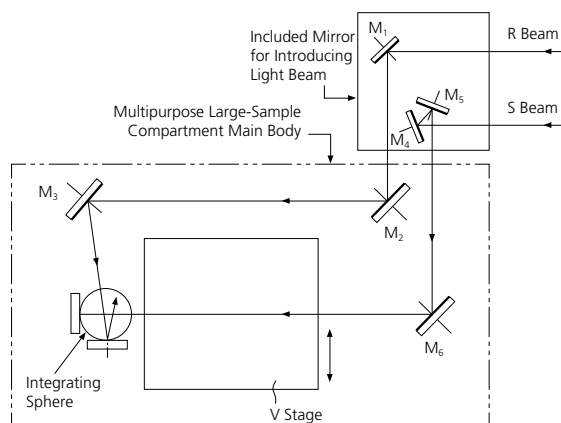

Optical System for Multipurpose Large-Sample Compartment

## Powdered Sample Holder (for Integrating Sphere)

(P/N 206-89065-41)

Powdered sample holder for installation in an integrating sphere.  
Can be installed in all integrating spheres.

- Minimum capacity is 0.16 mL.
- 3 holders are included.



## Micro Beam Lens Unit

(P/N 206-22051-41)

This unit uses a lens and mask to mask the beam that passes through the integrating sphere opening. The minimum beam diameter is about 1 mm. It requires a sample base plate integrating sphere unit at the same time.

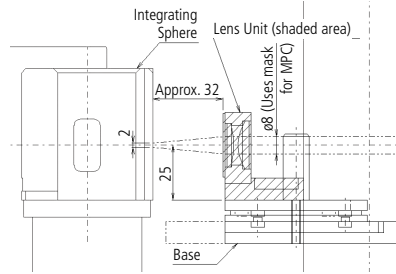

Overview Diagram



Note: For UV-2600(i), MPC-2600A and BIS-3100 sample base plate integrating sphere set are separately required.  
For UV-3600(i) Plus, MPC-603A and BIS-603 sample base plate integrating sphere set are separately required.  
For SolidSpec-3700(i)/3700(i) DUV, BIS-3700/3700DUV is separately required.

## Micro Sample Holder

(P/N 206-28055-41)

This holds solid samples about 5 to 10 mm square or in diameter and about 1 to 5 mm thick. Samples are held by clamping from above and below.

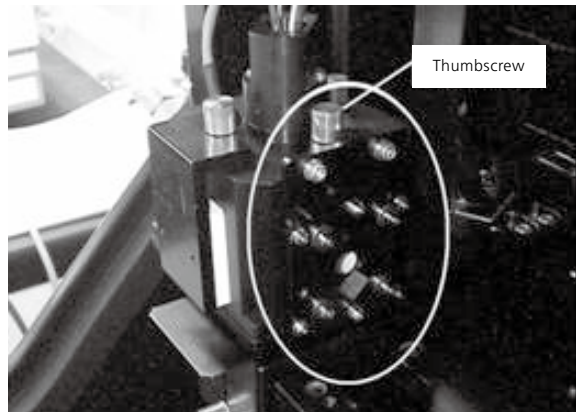

Mounted to the Integrating Sphere

## Cylindrical Sample Holder

Holds round glass samples for measurements using an integrating sphere. It can be used with MPC series or SolidSpec models.

5 to 25 mm dia. (P/N 207-23559-41)

30 to 50 mm dia. (P/N 207-23559-42)

40 to 110 mm dia. (P/N 207-23559-43)



## Absolute Specular Reflectance Attachments

These attachments are used to measure the absolute reflectance of specular reflected light, as indicated in Figure 2 (page 19). Reference samples are not used for absolute specular reflectance measurements as shown in the figure on right. By assuming 100% reflectance when no sample (air) is placed in the compartment, light reflected from the sample is measured. The attachment is installed in a Large-Sample Compartment Unit to measure the absolute specular reflectance of mirrors or other solid samples. It also requires a Sample Base Plate Integrating Sphere Set separately. When the incident angle is large (12°, 30° or 45°), a separately sold polarizer unit is required due to polarized light effects to ensure accurate measurements.

- V-N method enables switching between light paths for sample measurements and for 100% setting with a single step.
- Sample size: Approx. 25 mm dia. or 20 mm square up to 200 mm dia. or 150 mm square, and up to 30 mm thick

Model	P/N	Incident Angle	Wavelength Range		
			MPC-2600	MPC-2600A	MPC-3100/MPC-603A
ASR-3105	206-16817-58	5°	300 to 800 nm	300 to 1200 nm when using with UV-2600(i)	300 to 2400 nm
ASR-3112	206-16100-58	12°			300 to 2500 nm
ASR-3130	206-15001-58	30°			300 to 2300 nm
ASR-3145	206-15002-58	45°			

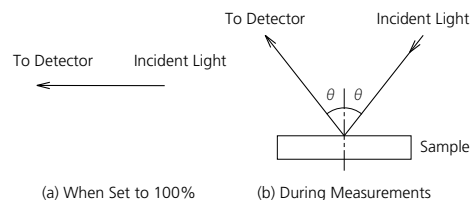

**Absolute Specular Reflectance Measurement**

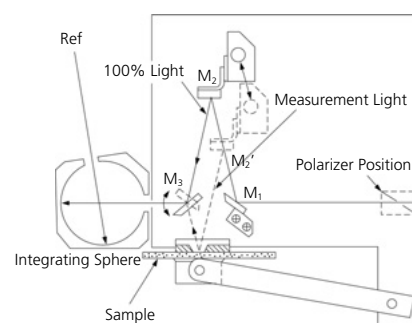

**Structure of Absolute Specular Reflectance Attachment**

## Sample Base Plate Integrating Sphere Sets

These sets include a sample base plate paired with an integrating sphere. The accessory is required for attaching absolute specular reflectance attachments to the main UV spectrophotometer unit.

Model	P/N	2600(i) 2700(i)	3600	3600(i) Plus	SolidSpec -3700(i)	SolidSpec -3700(i) DUV	Wavelength Range
BIS-3100	206-17059-58	✓	✓	✗	✗	✗	240 to 2600 nm
BIS-603	207-21100-58	✗	✗	✓	✗	✗	
BIS-3700	206-20880-51	✗	✗	✗	✓	✗	
BIS-3700DUV	206-20880-52	✗	✗	✗	✗	✓	175 to 2600 nm



## Large Polarizer Set Polarizer Type I, II, III Polarizer Adaptor Set

These attachments are used to perform the measurement without polarized light effects. These polarizers are used in Multipurpose Large Sample Compartments, Rotating Film Holder, or etc.

A Polarizer Adapter Set (P/N 206-15693) is required to use Polarizer Type I, II, or III in a Multipurpose Large Sample Compartments.

Description	P/N	Effective Diameter	Wavelength Range
Large Polarizer Set*	206-15694-40	20 mm	250 to 2300 nm
Polarizer Type I	206-13236-41	18 mm	400 to 800 nm
Polarizer Type II**	206-13236-42	17 mm	260 to 700 nm
Polarizer Type III	206-13163-40	10 mm	260 to 2300 nm

\*: This cannot be used with Glass/Film Holders (P/N 207-21573-41) or Rotating Film Holder (P/N 206-28500-41).

\*\* : This cannot be used with Absolute Reflectance measurement.



## Variable Angle Measurement Unit

For MPC-2600A (P/N 207-23490-41)

For MPC-603A (P/N 207-23490-42)

This allows measuring transmittance or absolute reflectance of solid samples at any angle of incidence or any angle of receiving light. When the incident angle is larger than 10°, a separately sold polarizer unit is required due to polarized light effects to ensure accurate measurements.

- Sample size: 20 to 100 mm square, thickness 15 mm max.
- Incident angle: 5 to 70 deg. (movable range: 0 to 90 deg.)
- Angle of receiving light: 10 to 140 deg. (movable range: 0 to 180 deg.)
- Photometric accuracy:  $\pm 3\%$  (MPC-2600A)  
 $\pm 1.5\%$  (MPC-603A)
- Wavelength range: 250 to 1400 nm (MPC-2600A)  
250 to 1650 nm (MPC-603A)

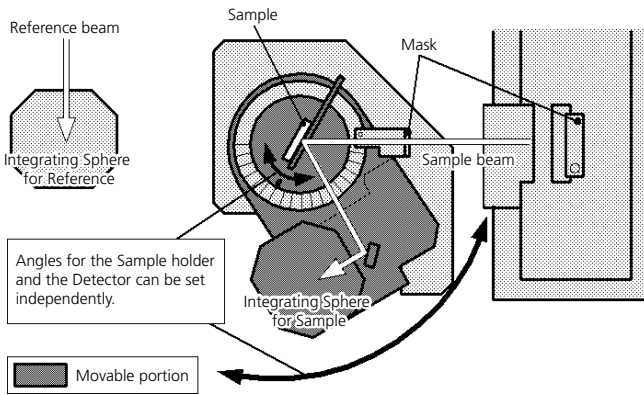
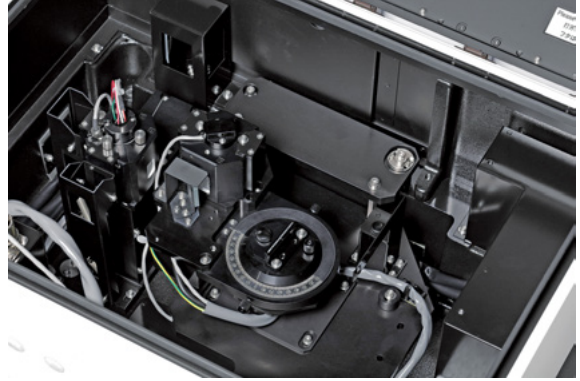

Overview Diagram

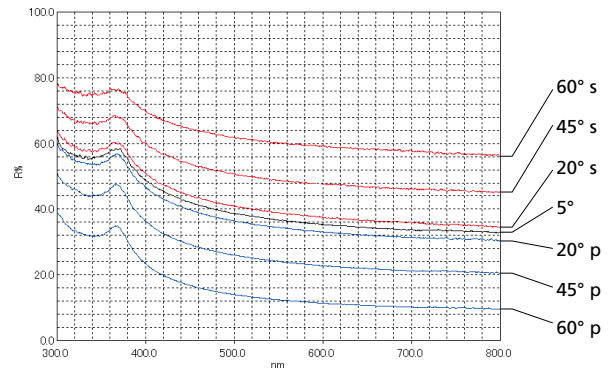

Absolute Reflectance from Silicon Wafer Mirror Surface at 5, 20, 45, and 60 Degree Angle of Incidence

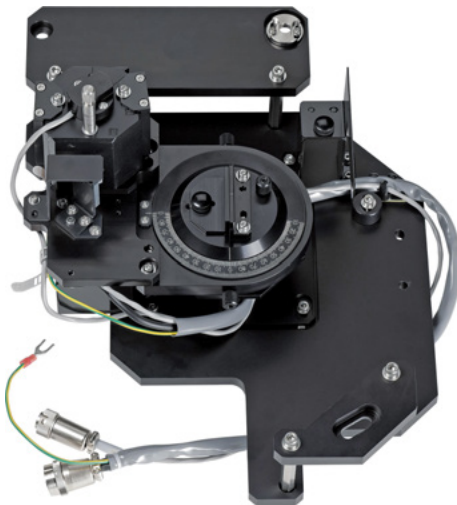

Variable Angle Measurement Unit



# Special Accessories for SolidSpec-3700

## Automatic X–Y Stage

(P/N 206-20810-59)

The Automatic X–Y Stage enables automatic measurements for the points specified in advance and is a powerful accessory for high-throughput measurements.

- Maximum sample size: 310 mm diameter or 310 × 310 mm, 40 mm thickness

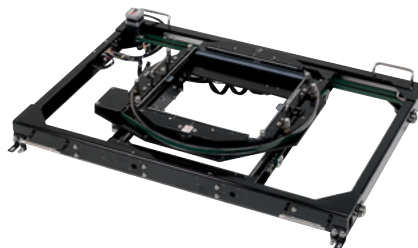

## Direct Detection Units

**DDU** SolidSpec-3700(i) only (P/N 206-20264-51)

**DDU-DUV** SolidSpec-3700(i) DUV only (P/N 206-20264-52)

The same sample compartment as a conventional UV-VIS spectrophotometer can be added to the SolidSpec-3700(i)/3700(i) DUV by mounting the Direct Detection Unit DDU or DDU-DUV.

- Measurement wavelength range:  
DDU: 190 to 3300 nm (when mounted in SolidSpec-3700(i))  
DDU-DUV: 165 to 3300 nm (when mounted in SolidSpec-3700(i) DUV)



## Purge Box

SolidSpec-3700(i) DUV only (P/N 206-21788-58)

The Purge Box is used with the DDU-DUV Direct Detection Unit, allowing the inside to be purged. The Purge Box has a film holder and a six-cell holder and allows the cell positions to be moved without opening the cover of the SolidSpec-3700(i) DUV.

- Maximum sample size: 60 × 60 mm, 20 mm thickness

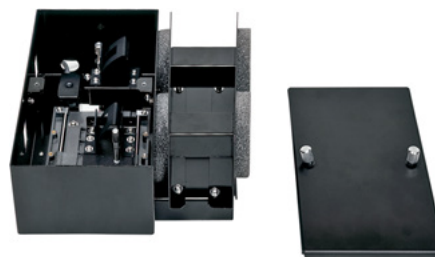

## Large Specular Reflectance Attachment (5° Incident Angle)

(P/N 206-20570-58)

The Large Specular Reflectance Attachment is needed for relative specular reflectance measurements. This accessory is mounted in the main body of SolidSpec-3700(i)/3700(i) DUV and enables reflectance measurements while keeping the samples horizontal. The Direct Detection Unit DDU or DDU-DUV is not required for this accessory.

- Applicable sample size: maximum W 470 × D 560 × H 40 mm

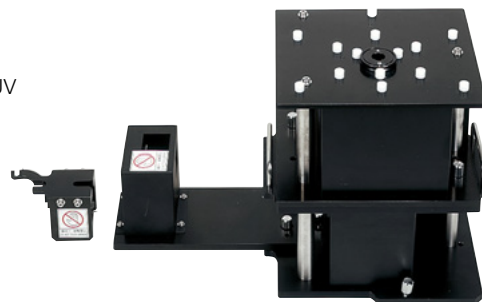

## Variable Angle Measurement Unit

For 100V (P/N 207-23470-41)

For 230V (P/N 207-23470-42)

This allows measuring transmittance or absolute reflectance of solid samples at any angle of incidence or any angle of receiving light.

When the incident angle is larger than 10°, a separately sold polarizer unit is required due to polarized light effects to ensure accurate measurements.

- Sample size: 20 to 100 mm square, max. 15 mm thickness.
- Incident angle: 5 to 70 deg. (movable range: 0 to 90 deg.)
- Angle of receiving light: 10 to 140 deg. (movable range: 0 to 180 deg.)
- Photometric accuracy:  $\pm 1.5\%$
- Wavelength range: 250 to 2500 nm

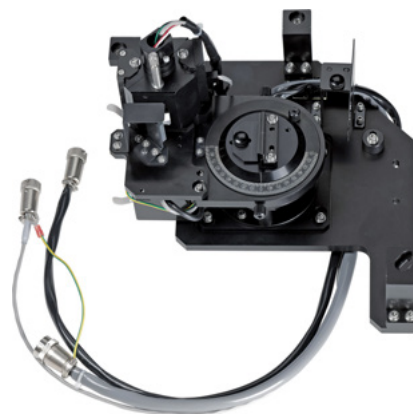

## Square Cell Holder for Integrating Sphere

(P/N 206-22339-92)

10 mm square cell holder for integrating sphere built into SolidSpec-3700(i)/3700(ii) DUV systems.

## Printer, Interface, Cable

### DPU-S445 Screen Copy Printer

UV-1280, UV-1800/1900(i) only (P/N 207-23484-48)

Prints hard copies of screens, including numeric data. A printout is made after each measurement.

Spectra, kinetics reaction data, and quantitation calibration curves displayed on the screen are output in the screen print. A hard copy can be printed at any time, making it simple to record measurement parameters. The printer cable is included.

- Size: W 145 × D 135 × H 58 mm
- Thermal paper (10 rolls) (P/N 088-58907-04)
- Power supply: 100 to 120 or 200 to 240 V AC, 50/60 Hz, 25 VA



AC Power Cable for DPU-S445		
Description	P/N	Country/Region
Cable CB-US04-18A-E	088-52083-36	U.S., Canada
Cable CB-CE01-18B-E	088-52083-38	EU, EFTA
Cable CB-UK01-20A-E	088-52083-51	UK

### Analog Signal Output Interface

UV-1280, UV-1800/1900(i), UV-2600(i)/2700(i) only (P/N 206-25233-91)

This interface is used when using an analog data recorder to record the measurement signal from a spectrophotometer. It provides analog signal output, such as for monitoring liquid chromatography, and can be connected to an integrator.

- Analog output full scale: 100 mV/2 Abs. or 100 mV/100%T

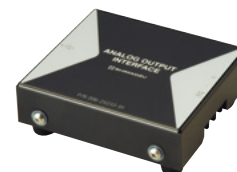

### USB Interface Cable

UV-1280, UV-1800/1900(i) only (P/N 088-50602-49)

Used to connect the spectrophotometer to the PC.

# Optional Program

## Water Analysis Program

UV-1280 only (P/N 207-22430-42 English, 207-22430-43 Chinese)

Easy and accurate water analysis can be conducted in combination with simplified reagents.

- All measurement parameter settings are included internally for 22 sample types / 39 items for the UV-1280. All items, including measurement wavelengths, calibration curve, measurement time, and measurement concentration range, are set automatically by simply selecting the item.
- Results can be acquired even without analytical knowledge through operation in accordance with screen instructions. The pack comes with an analysis guide that displays the model number of the reagent to be used and the operation procedure, so there is no need to refer to the manual.
- If the optional multicell holder (6 cells) is used, up to six cells can be measured consecutively in one analysis.
- Automatic analysis commences after a specified time. The elapsed time is displayed on screen, concentration values are displayed automatically after the specified time has elapsed, and a buzzer sounds to state that analysis is complete.
- Required sample volume is approximately 1.5 mL. (Except some of the items)

Note: Conjunction measurement with the shipper unit is not possible.

### List of Measurable Items

Symbol	Measurable item
ClO	Residual chlorine (Free)
CN	Free Cyanogen
	Total Cyanogen
COD	COD (chemical oxygen demand)
Color	Color
Cr	Hexavalent chromium
	Hexavalent chromium + 50 mm cell
	Total Chromium
Cu	Copper
F	Fluorine (Free)
Fe	Bivalent iron
	Bivalent iron at low concentration
FOR	Formaldehyde
H <sub>2</sub> O <sub>2</sub>	Hydrogen peroxide
Mn	Manganese
NH <sub>4</sub>	Ammonium
	Ammonium-nitrogen
Ni	Nickel
NO <sub>2</sub>	Nitrite
	Nitrite-nitrogen
NO <sub>3</sub>	Nitrate (No NO <sub>2</sub> mixed)
	Nitrate (NO <sub>2</sub> 0.005 mg/L or less)
	Nitrate (NO <sub>2</sub> 5.0 mg/L or less)
	Nitrate-nitrogen (No NO <sub>2</sub> -N mixed)
	Nitrate-nitrogen (NO <sub>2</sub> -N 0.0015 mg/L or less)
Nitrate-nitrogen (NO <sub>2</sub> -N 1.5 mg/L or less)	
Pb	Lead (SPK)
Phenol	Phenol
PO <sub>4</sub>	Phosphate
	Phosphate (enzyme method)
	Phosphate phosphorus
	Phosphate phosphorus (enzyme method)
S	Sulfide (Hydrogen sulfide)
TH	Total hardness
Turbid.	Turbidity (Formazin)
	Turbidity (Polystyrene)
Zn	Zinc.: Not including other metals

For information about reagents, contact:  
**Kyoritsu Chemical-Check Lab., Corp.**  
 (Manufacturer and Distributor)  
 5-37-11, Den-enchofu, Ota-ku,  
 Tokyo, 145-0071, Japan  
 Tel: +81-3-3721-9207 Fax: +81-3-3721-0666  
<https://kyoritsu-lab.co.jp/english/>

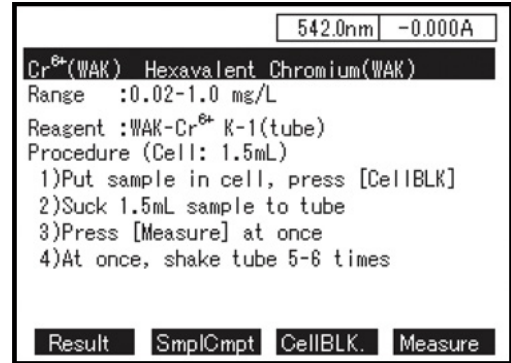

Operation Screen

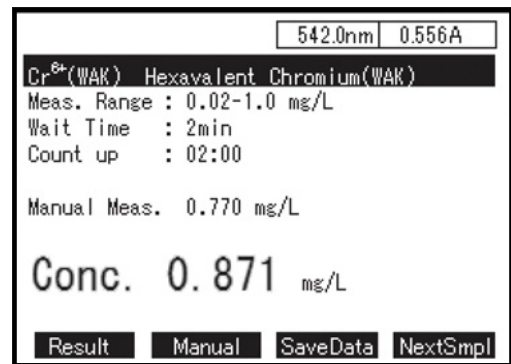

Measuring Screen

# Software

## LabSolutions UV-Vis (Included as standard in UV-i selection)

(P/N 207-24525-92)

LabSolutions UV-Vis is a next-generation Shimadzu UV control software pursuing efficiency of analysis. The simple design layout enables even first-time users to perform operations easily. A new spectrum evaluation function automates the measurement, analysis, and printing of reports to significantly enhance the efficiency of routine analysis. In addition, it achieves the easy transfer of measurement data. Users can export the measurement data in text format and import it into other software for analysis with Excel®.



### Simple Design

From the start, the software's user-friendliness allows users to perform operations with ease. With extensive features, LabSolutions UV-Vis meets a wide range of users' expectations.

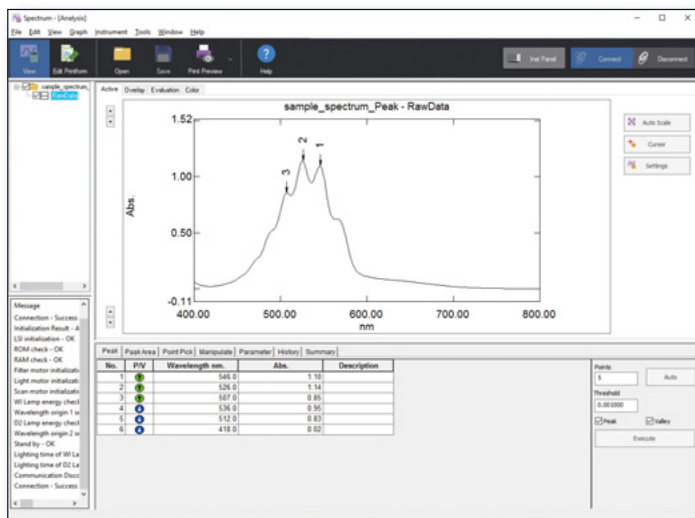

Simple Main Window

Clear and simple layout of the graphs and measurement results makes it easy to read.

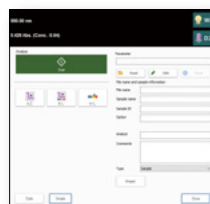

Instrument Control Panel

The instrument control panel that brings together the measurement functions enables automatic measurement, analysis and reporting.

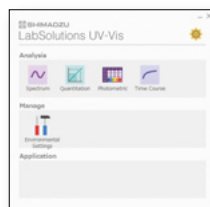

Easy-to-follow Configuration Window

Large icons make it easy for users to understand and operate.

### Four Measurement Modes

It permits four measurement modes: spectrum, quantitative, photometric, and time course.

Users can open multiple measurement modes at the same time, so that data analysis can be performed in one mode while collecting data in another mode.

### Report

Easily create report layouts.

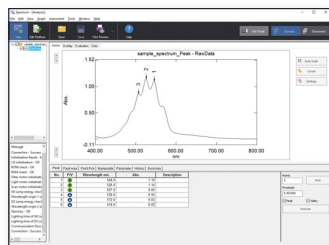

Print from the measurement window with one click.

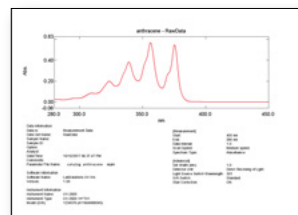

Report is printed.

## Spectra Evaluation Function

In addition to providing measurement and analysis results, judgment results are also provided. With this feature, LabSolutions UV-Vis enables users to maintain a product's quality.

The screenshot shows the LabSolutions UV-Vis interface. On the left, a spectrum plot displays absorbance versus wavelength. Below the plot is a table with columns for 'Measuring Mode', 'Peak', and 'Area'. A red box highlights a row in this table. On the right, the 'Detail Settings (Cutoff + Over)' window is open, showing a tree view of evaluation criteria such as 'Measuring Mode', 'Peak', 'Area', and 'Valley'. The 'Peak' section is expanded, showing options like 'Single Point', 'Ratio (A-E)', 'Difference (A-E)', 'Minimum Wavelength', and 'Peak Width'. The 'Area' section is also expanded, showing 'Single Point', 'Ratio (A-E)', 'Difference (A-E)', and 'Peak Area'. The 'Evaluation' field is set to 'OVER\_FROM\_SHORT\_SIZE(200.00:800.00,1.00000)'. The 'Number of decimal' is set to 1, and the 'Perform pass/fail judgment' checkbox is checked, with the evaluation value set to '>= 1.0'.

Quality of the sample can be determined with comprehensive judgment at a glance.

Multiple evaluation criteria can be set.

Detail Settings Window

Evaluation method can be selected from a wealth of choices.

## Easy Transfer of Measurement Data

Users want to export measurement data immediately in text format, and import for analysis in other software, such as Excel.

The screenshot shows the LabSolutions UV-Vis interface. On the left, a spectrum plot displays absorbance versus wavelength. Below the plot is a table with columns for 'Wavelength (nm)', 'Abs', and 'Description'. A red box highlights a row in this table. On the right, the 'sample\_spectrum\_Peak - RawData' plot is shown, displaying absorbance versus wavelength.

To Analysis Software

Automatically generates a text file when the spectra data are saved. It can be immediately imported into other software.

The screenshot shows a Notepad window with a text file containing the following data:

Wavelength (nm)	Absorbance
280.0	0.02
281.0	0.02
282.0	0.02
283.0	0.02
284.0	0.02
285.0	0.02
286.0	0.02
287.0	0.02
288.0	0.02
289.0	0.02
290.0	0.02
291.0	0.03
292.0	0.03
293.0	0.03
294.0	0.03
295.0	0.03
296.0	0.04
297.0	0.04
298.0	0.03
299.0	0.04
300.0	0.04

To Excel

Real-time transfer of the spectrum waveform to Excel during measurement.

No need to create a CSV file each time.

The screenshot shows an Excel spreadsheet with the following data:

Wavelength (nm)	Sample (mg)
300	0.067032
300.5	0.066437
301	0.06572
301.5	0.065104
302	0.06436
302.5	0.063551
303	0.06266
303.5	0.07135
304	0.07399
304.5	0.077103
305	0.080582
305.5	0.084305
306	0.088313
306.5	0.092575
307	0.096129

## Matrix Output

Outputs multiple spectra to one text file.

Easy to import data into multivariate analysis software.

The screenshot shows a Notepad window with a text file containing the following data:

Wavelength (nm)	RadData, sample_1 - RadData	RadData, sample_2 - RadData
280.0	0.02	0.12
281.0	0.02	0.11
282.0	0.02	0.10
283.0	0.02	0.09
284.0	0.02	0.08
285.0	0.02	0.08
286.0	0.02	0.07
287.0	0.02	0.07
288.0	0.02	0.06
289.0	0.02	0.06
290.0	0.02	0.05
291.0	0.02	0.05
292.0	0.02	0.05
293.0	0.02	0.05
294.0	0.02	0.05
295.0	0.02	0.05
296.0	0.02	0.05
297.0	0.02	0.05
298.0	0.02	0.04
299.0	0.02	0.04
300.0	0.02	0.04

Line up wavelengths vertically.

Line up wavelengths horizontally.

Select how the data is ordered.

Shimadzu offers LabSolutions DB UV-Vis and LabSolutions CS UV-Vis to meet the requirements of ER/ES regulations.

## LabSolutions DB UV-Vis

(P/N 207-24526-92 English, 207-24526-93 Chinese)

LabSolutions DB UV-Vis System can be established by introducing the database system. The system allows for data management and user management with a database. Compliant with ER/ES regulations, the system is optimally configured for customers using a PC.



## LabSolutions CS UV-Vis

(P/N 207-24527-92 English, 207-24527-93 Chinese)

UV-Vis can be added to LabSolutions CS as an acquisition controller. The system is optimally configured for customers who want to manage data on a server together with LC and GC data for ER/ES compliance.

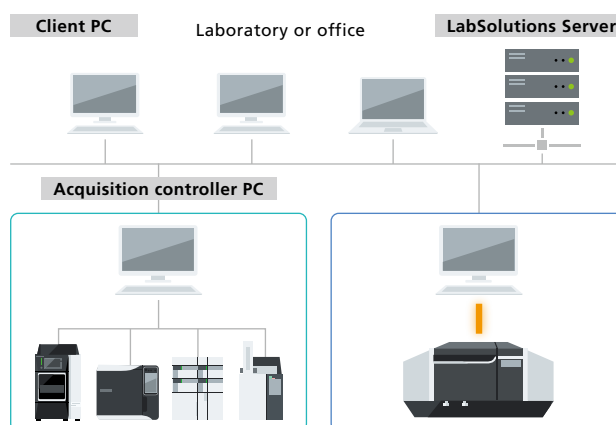

Name	LabSolutions UV-Vis	LabSolutions DB UV-Vis System	LabSolutions CS UV-Vis System
Data management method	Measured data files are saved and managed in folders on the PC.	Measured data files are saved and managed in the LabSolutions database.	
Data references	The software references files on drives or in folders on the PC.	The software references files in the database.	
LabSolutions database	Unavailable	Available (The database resides on a local PC)	Available (The database resides on a server)
User administration	Unavailable	Available	
Rights group administration	Unavailable	Available	
Project administration	Unavailable	Available	
Standalone/network	Only the standalone configuration can be used.	Only the standalone configuration can be used.	Only databases on the network can be used. (LabSolutions UV-Vis data can be viewed using the database manager on a PC set up for viewing purposes. Note that LabSolutions UV-Vis must be installed on the PC used for viewing.)
Data backup	Performed on a file-by-file basis using Windows Explorer.	Performed for each database.	

## Upgrade Kit to LabSolutions DB/CS UV-Vis

Upgrade Kit to LabSolutions DB UV-Vis (P/N 207-24526-95 English, 207-24526-96 Chinese)

Upgrade Kit to LabSolutions CS UV-Vis (P/N 207-24527-95 English, 207-24527-96 Chinese)

Upgrade Kit is necessary for customers who have LabSolutions UV-Vis alone.



## Database Management Prevents Mistakes

With LabSolutions DB UV-Vis System and LabSolutions CS UV-Vis System, the analysis data are managed securely by the database. Overwriting, deletion and other mistakes typical of data file management do not occur.

In addition, when postrun analysis is performed using the acquired data, postrun analysis data revision numbers are automatically assigned, preventing the accidental overwriting of raw data.

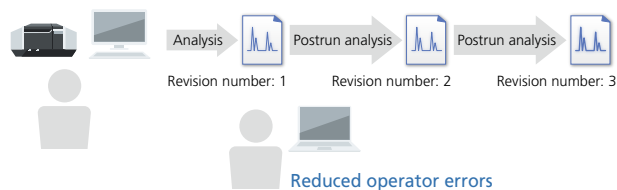

## Solid Security

An audit trail to ensure the reliability of data and document e-mail transmission functions when any event occurs in the system can be set up. User accounts are managed using passwords, where password length, complexity and term of validity must satisfy specified

requirements. It is also possible to set lockout functions to prevent illegal access, and set a registered user's deletion and change. In addition, a box can be selected to prevent overwriting a data file, and outputting an item to a report can also be performed.

## Pertinent Information Managed for Every Project

LabSolutions DB UV-Vis System and CS UV-Vis System provide a project management function enabling management suited to tasks and system operations. This function enables equipment and user management, security policy, and data processing to be set on a project-by-project basis, thereby improving the efficiency of data searches and management tasks.

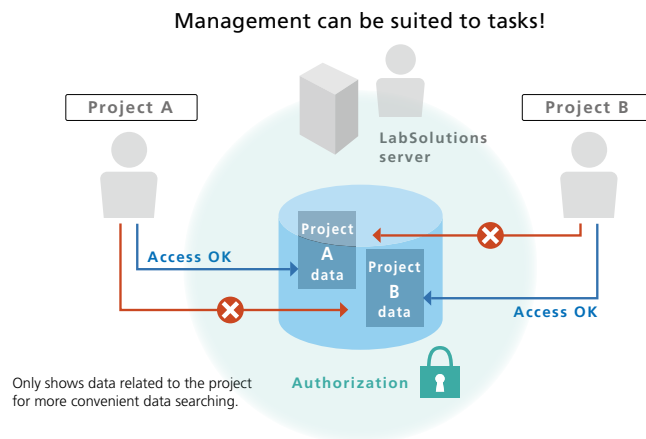

## Visualization of the Sequence of Analysis Operations

Creating a report set\* provides visibility of the individual analytical operations involved in the overall analytical process. When analytical operations are visible, it is easier to check for operating errors, which helps improve the efficiency and reliability of checking processes.

\* Report sets include test methods and test results for a series of samples analyzed, and also a corresponding operation log (a record of all operating events from login to logout), which is automatically extracted from the data and summarized in a single report.

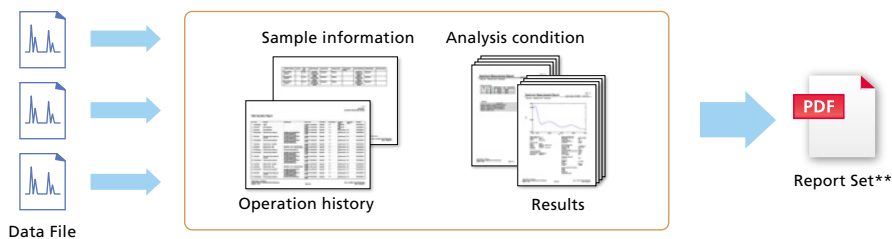

## UV Performance Validation Software

(P/N 206-28340-92 English, 206-28340-93 Chinese)

UV performance validation software allows you to easily perform routine performance validation. It also makes it easier to check the performance of the equipment and manage records, making it possible to strictly comply with regulations.

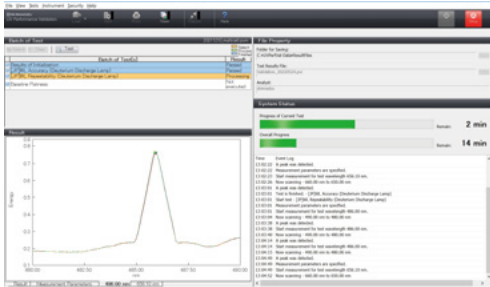

The results of the inspection can be printed or saved to a file. After inspection, you can read and check the result. The inspection conditions can be saved as a file, and can be read and executed for each inspection content.

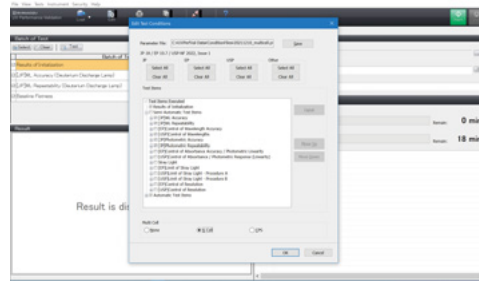

It is possible to check the performance indication of the equipment described in General Rules for Molecular Absorptionmetric Analysis of JIS K0115 and to perform the performance inspection required in the pharmacopoeia JP, USP and EP. (Please prepare options and reagents for testing separately.)

## VisEase Simple Control Application

(P/N 207-26411-91)

No data analysis, reporting, or printing. "Do measure more easily". This is the software for such requests. All operations such as selecting the measurement mode and starting the measurement can be performed with one click from the main screen where only the necessary parts are gathered. You can save the measurement results in either text or Excel format.

Note: Graphing, reporting, and data processing functions are not provided.

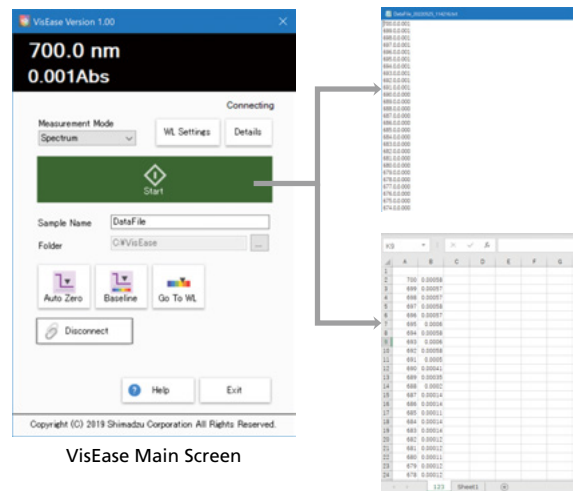

VisEase Main Screen

## Tm Analysis Software

(P/N 206-57476-91)

This software is used with the S-1700 cell holder. It enables temperature versus absorbance graph data to be uploaded to a computer for analyzing the  $T_m$  (melting temperature) of nucleic acids (DNA and RNA) or other substances.

- OS: Windows 10 Pro 64 bit edition, Windows 7 Professional 32/64 bit edition

Note 1: A separate RS-232C cable (P/N 208-94860) is required for connecting a computer to the S-1700 cell holder.

Note 2: If used for the UV-1800/1900(i) spectrophotometer, a separate USB cable (P/N 088-50602-49) is required for connecting the computer to the main unit.

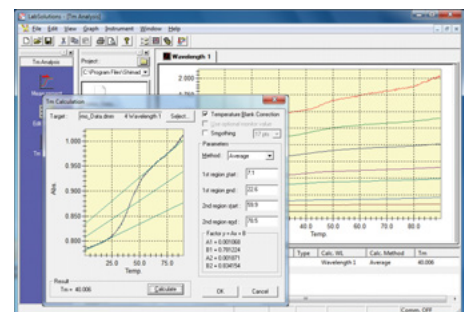



## Automatic Analysis

(P/N 207-25807-91)

This software is used to control the ASX-560/280 auto sampler.

The CETAC connection kit (P/N 207-26525-41) is required to connect UV equipment to the ASX-560/280.

---

## Solar Transmittance Measurement

(P/N 207-25805-91)

This software calculates solar transmittance/reflectance from the measured spectrum.

- It also can calculate visible light transmittance/reflectance, total light transmittance/reflectance, Near-infrared reflectance, Ultraviolet light transmittance, CIE damage factor and Skin damage factor.
- Calculations related to ISO, JIS and GB/T are also possible. \*

\*: For details on the supported standards, please contact us.

# Optional Software for UVProbe

## LabSolutions Connection Kits

LabSolutions DB Connection Kit (P/N 207-21250-92 English, 207-21250-93 Chinese)

LabSolutions CS Connection Kit (P/N 207-21251-92 English, 207-21251-93 Chinese)

This software is used to perform operations such as measuring data using UVProbe, automatically registering processed data and PDF report files in a LabSolutions database, securely managing data, or applying electronic signatures. Using these kits allows UVProbe to be compliant with FDA 21 CFR Part 11. They also provide network capability, which allows using a server computer to centrally manage data from other analytical instruments, such as HPLC, GC, or FTIR systems, by installing software that is compatible with such instruments. Viewing the data from a client computer on the network is also made possible.

- **Access Control and User Management**  
FDA 21 CFR Part 11-compliant access control can be achieved by using a user authorization server to centrally manage which users can access the program, regardless of the operating system, in the same manner as with UVProbe. To prevent those without proper access rights from accidentally changing settings, access restrictions for specific functionality can be specified for each registered user with access permission.
- **Security and Audit Trails**  
Even if electronic records are changed, data before the changes are not lost because all electronic records are saved and managed in a database. In addition, a record of system usage, a history of revisions to data recorded in the database, and so on are recorded automatically together with the date and person that performed each process.
- **Data Integrity and Electronic Signatures**  
Data is automatically saved in the database and cannot be deleted. Data saved in the database can be easily restored, displayed, or reanalyzed. Electronically recorded data can be signed with an electronic signature and linked to analytical data, so that the signer's name, signature date, and reason for signature are saved together with the data.
- **Managing Related Information for Each Project**  
LabSolutions includes a project management function that allows managing information based on the type of process or system used. This function makes it possible to specify different settings for each project concerning instrument management, user management, security policy, and data processing. This helps ensure that searching data and other management processes can be performed smoothly.
- **OS: Windows 10 Pro 64 bit edition, Windows 7 Professional 32/64 bit edition**

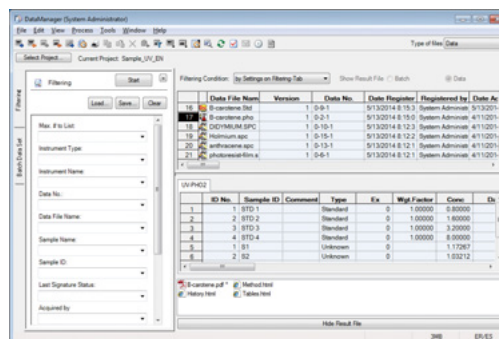

LabSolutions Data Manager

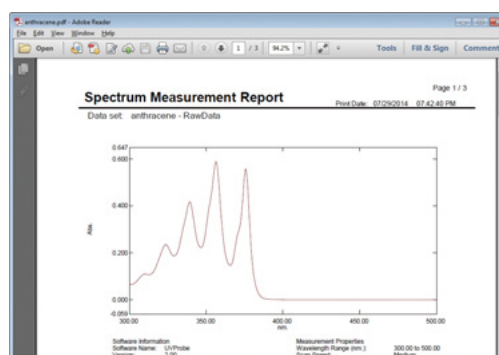

PDF Report of Data



Shimadzu Corporation  
[www.shimadzu.com/an/](http://www.shimadzu.com/an/)

**For Research Use Only. Not for use in diagnostic procedures.**

This publication may contain references to products that are not available in your country. Please contact us to check the availability of these products in your country.

Company names, products/service names and logos used in this publication are trademarks and trade names of Shimadzu Corporation, its subsidiaries or its affiliates, whether or not they are used with trademark symbol "TM" or "®".

Third-party trademarks and trade names may be used in this publication to refer to either the entities or their products/services, whether or not they are used with trademark symbol "TM" or "®".

Shimadzu disclaims any proprietary interest in trademarks and trade names other than its own.

The contents of this publication are provided to you "as is" without warranty of any kind, and are subject to change without notice. Shimadzu does not assume any responsibility or liability for any damage, whether direct or indirect, relating to the use of this publication.