

Genius AB-3G

User Manual

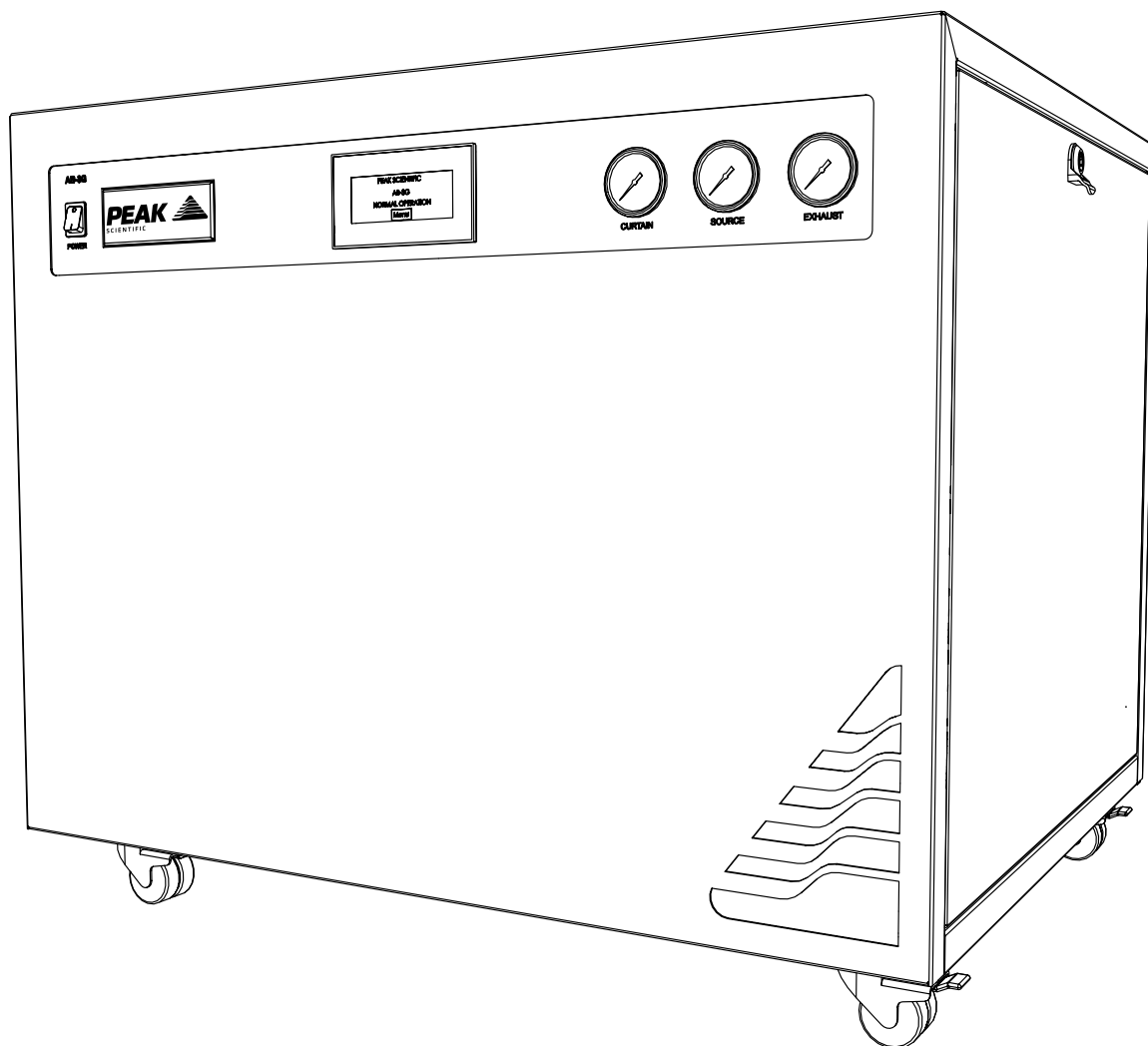

Contents

Change History	3
How to use this Manual	3
Introduction	4
Warranties and Liabilities	5
Warranty & Liability Coverage	5
Safety Notices	7
Declaration of Conformity	8
Environmental Declaration	9
Technical Specification	10
Unpacking	11
Fittings Kit Contents	12
Installation	13
Generator Environment	13
Generator Overview	14
General Dimensions	14
Rear Connections	15
Electrical Connection	16
Start-Up Sequence	17
Operating Modes	19
Normal Operation	19
Standby Mode	19
High Altitude Mode	19
HMI User menus	20
On Demand Gas	22
Generator Cycling	22
Unusual Operation	22
Fault Warning	23
Connecting to the application	24
Tubing Lengths	24
Service Requirements	25
Service Schedule	25
Peak Protected	26
Cleaning	27
Troubleshooting	28

Change History

Rev	Comment	Name	Date
1	Declarations Update	L. Couattie	20/04/2017

How to use this Manual

This manual is intended for end users and has been written as a reference document where you can skip to the relevant information.

Users can refer to the contents page to find the relevant information.

Please review each of the following sections carefully.

Thank you for selecting Peak Scientific to meet your gas generation needs, and should you require any further assistance or support please do not hesitate to contact Peak Scientific or the Peak Partner from which you purchased your generator.

Introduction

The Genius AB-3G nitrogen generator is designed specifically for use with Sciex LC/MS instruments. This premium model offers safeguards that are unique to Peak Scientific generators and effectively deliver reassurance and confidence for critical functions.

These model provide a source of nitrogen gas with other features including:

- Reassurance - Designed with back-up compressor capacity
- Fail-Safe - Continuous operation to allow for scheduled maintenance
- Confidence - Designed and built around extensive tried and tested processes.
- Intelligent - High duty service indicator
- Independant - No external compressor required
- Quiet - Insulated compressor compartment for minimum disruption
- Mobile - Flexibility to position the generator where required
- Simple installation - Generator designed as a plug and play system
- Economical - More cost effective than any other gas supply method
- Convenient - Gas on demand, no hazards, no need to worry about running out of gas

The Genius AB-3G is based on proven technology, and selectively removes oxygen, moisture and other gases to leave clean, dry, phthalate free nitrogen and dry air. Internal air compressors make this unit independent from in-house air supplies and fitted castors allow the user to easily position the unit in the lab.

To ensure this Generator model meets our high expectations with regards to reliability and performance, we have tested it extensively at our manufacturing plant and with end users around the world to ensure reliability and longevity of the system.

Warranties and Liabilities

Warranty & Liability Coverage

1. Peak warrants that, subject to the provisions in this statement, purchased Peak generators, whether purchased directly from Peak or indirectly via an approved, certified and trained distributor or partner (referred to hereafter as a "Peak Partner") will comply in all material respects with any specifications referred to in your customer order confirmation and, subject to installation and operational guidelines being followed as described in applicable product manuals, shall be free from any defects in quality of materials or workmanship for a period of one year from the date of installation, provided this takes place within 3 months of factory dispatch.
2. Where the purchased generator is from the Precision Hydrogen series, Peak further warrants that, subject to installation and operational guidelines being followed as described in applicable product manuals, the hydrogen cell shall be free from any defects in quality of materials or workmanship for a total period of three years (inclusive of warranty period specified in clause 1) from date of installation, provided this takes place within 3 months of factory dispatch.
3. Where the purchased generator is from the i-Flow 6000 series, Peak further warrants that, subject to installation and operational guidelines being followed as described in applicable product manuals, the generator shall be free from any defects in quality of materials or workmanship for a total period of two years (inclusive of warranty period specified in clause 1) from the date of installation, provided this takes place within 3 months of factory dispatch and the following provisions have also been met:
 - a. you must purchase a service plan, ensuring the generator is serviced by Peak or a Peak Partner on or before the end of the first 12 months of your ownership, and serviced at least once during each subsequent 12 month period thereafter;
 - b. the generator (and any associated equipment) must have been commissioned by Peak or a Peak Partner;
 - c. the feed air or inlet air supply to the generator must comply with ISO 8573-1:2010 Class 1.2.1 at all times;
 - d. your air compressor, dryer, filtration and oil removal systems must be deemed suitable for use by Peak or a Peak Partner, and must be changed and serviced regularly, in line with the equipment manufacturer's recommended guidelines; and
 - e. any generator failure or fault that is deemed to have been caused by the failure of any upstream equipment, component, part or system (such as air compressor, air treatment or filtration) will be excluded from the warranty described herein.
4. Peak also warrants that any replacement parts whether purchased (directly from Peak, or via a Peak Partner) or supplied as part of any remedial action undertaken in line with the provisions of clauses 12 and 13, shall be free from any defects in quality of materials or workmanship for a period of 180 days from the date of factory dispatch, provided its installation is performed by Peak or a Peak Partner.
5. This warranty does not exclude Peak's liability in respect of any claim for death or personal injury to any person, in so far as such can be attributed to negligence or breach of duty of care directly resulting from failure of Peak to comply with the provisions in clauses 1, 2, 3 & 4.

Exclusions & Limitations

6. This warranty does not cover:
 - a. damage, deterioration or malfunction resulting from an alteration or modification to a generator which has not been carried out by Peak or a Peak Partner;
 - b. damage, deterioration or malfunction resulting from what Peak reasonably believes to be abuse, or misuse of a generator by you or any third party;
 - c. liability for accident or neglect (other than pursuant to clause 5);
 - d. maintenance or repairs which have not been carried out by Peak or a Peak Partner;
 - e. operation of a generator or exposure of a generator to environmental conditions that fall out-with operational guidelines as specified in the applicable product user manual; and
 - f. lightning, power surges or any other acts of God or nature.
7. This warranty is non-transferrable. Only the original owner of the generator may benefit from the terms within this statement.

8. Peak shall not be liable in respect of any claim made for costs, damages, losses or expenses (whether consequential, direct, indirect or otherwise) or in any respect howsoever arising including, but not limited to, liability from accident or negligence (other than pursuant to clause 5) that may be suffered by you or any third party.
9. No person or entity is authorised to change the terms and conditions outlined in this warranty statement in any respect, or to create any additional obligations or liabilities for any party involved.
10. This warranty statement supersedes any and all prior warranty agreements between the parties and constitutes the complete, final and exclusive understanding of the parties with respect to the subject matter. All prior negotiations, representations, or promises, whether oral or written, of either party shall be deemed to have been merged herein.
11. If any part of this warranty statement is invalidated, for whatever reason, such part will be deleted and the rest shall remain unaffected, continuing to be in full force and effect.

Delivery of Warranty Service



12. Subject to clause 13, and:
 - a. Peak being notified by you, within the duration of the applicable warranty period, of any defect that you think is subject to any warranty valid under clauses 1, 2, 3 or 4; and
 - b. Peak being permitted to inspect the generators, parts and their installation (along with any relevant packaging)
Peak shall at its option repair or replace defective generators or parts (including, if necessary, any moving parts and irrespective of runtime). No additional charges will apply, for parts or delivery and, where applicable, labour or travel. Peak will endeavour to deliver this service within 3 working days of your notification.
13. Where, in Peak's reasonable opinion, a defect is subject to an exclusion described in clause 6, Peak reserves the right to charge for parts or delivery and, where applicable, you may also be charged by Peak for call out, labour or travel in respect of any repair or replacement which you authorize Peak to carry out.

Safety Notices

Peak Scientific Instruments cannot anticipate every possible circumstance which may represent a potential hazard. The warnings detailed within this manual refer to the most likely potential hazards, but by definition cannot be all inclusive. If the user employs an operating procedure, item of equipment or a method of working which is not specifically recommended by Peak Scientific, the user must ensure that the equipment will not be damaged or become hazardous to persons or property.

Symbols

This manual uses the following symbols to highlight specific areas important to the safe and proper use of the generator.

 WARNING	A WARNING notice denotes a hazard. It calls attention to an operating procedure, process or similar, which if not correctly performed or adhered to, could cause personal injury or in the worst case death. Do not proceed beyond a WARNING notice until the indicated conditions are fully understood or met.
 CAUTION	A CAUTION notice denotes a hazard. It calls attention to an operating procedure, process or similar, which if not correctly performed or adhered to, could cause damage to the generator or the application. Do not proceed beyond a CAUTION notice until the indicated conditions are fully understood or met.
	Caution, risk of electric shock. Ensure power to the generator has been removed before proceeding.

Safety Notice to Users



These instructions must be read thoroughly and understood before installation and operation of your Peak Generator. Use of the generator in a manner not specified by Peak Scientific MAY impair the SAFETY provided by the equipment.



When handling, operating or carrying out any maintenance, personnel must employ safe engineering practices and observe all relevant local health and safety requirements and regulations. The attention of UK users is drawn to the Health and Safety at Work Act 1974, and the Institute of Electrical Engineers regulations.



If the equipment is used in a manner not specified by the manufacturer, the protection provided by the equipment maybe impaired.

Declaration of Conformity

We Peak Scientific Instruments Ltd.
Of Fountain Crescent, Inchinnan, Renfrewshire, PA4 9RE

Declare that:

Equipment: Nitrogen Gas Generator
Models: Genius AB-3G & AB-3G Hi-Flow

To which this declaration relates, is in conformity with the applicable EC directives, harmonized standards, and other normative requirements.

- Low Voltage Directive 2014/35/EU
EN 61010-1: 2010 Electrical Equipment for measurement, control and laboratory use.
- Electromagnetic Compatibility Directive 2014/130/EU
EN 61326-1: 2013 Electrical Equipment for measurement, control and laboratory use.
- FCC47 CFR Part 15 Class B
Unintentional radiators; Conducted and Radiated emissions limits.

All evaluation, testing and certification issued by:

Nemko Canada Inc.

303 River Road
Ottawa
Ontario
Canada
K1V 1H2

Signed:  Name: Chris Pugh

Date: 20/04/2017 Position: Chief Technology Officer



Environmental Declaration

We Peak Scientific Instruments Ltd.
Of Fountain Crescent, Inchinnan, Renfrewshire, PA4 9RE

Declare that:

Equipment: Nitrogen Gas Generator

Models: Genius AB-3G & AB-3G Hi-Flow

Is fully compliant with the following Directives

- 2012/19/EU WEEE (Waste of Electrical and Electronic Equipment)
- 2011/65/EU RoHS 2 (Restriction of Hazardous Substance)

Peak Scientific Instruments Ltd fully complies with its obligations towards the European WEEE (Waste of Electrical and Electronic Equipment) Directive 2012/19/EU. These obligations are being met within the B2B compliance group.

Peak Scientific Instruments Ltd has developed all reasonable 'due diligence' controls to ensure that our products comply with the principles and requirements of the European recast RoHS (Restriction of Hazardous Substances) Directive 2011/65/EU. Similar directives in the United States and China, for example, have also been captured within this program.

Where a specific certificate of compliance is required, this can be requested, on a product serial number basis, directly from Peak Scientific Instruments Ltd, by contacting us through our website on www.peakscientific.com

Signed:  Name: Chris Pugh

Date: 20/04/2017 Position: Chief Technology Officer



Technical Specification

Genius AB-3G

Environment

	AB-3G	AB-3G Hi-Flow
Minimum Operating Ambient Temperature	5°C (41°F)	
Maximum Operating Ambient Temperature	30°C (86°F)	
Maximum Altitude	2000 m	
Maximum Relative Humidity	70%	
Minimum Storage Temperature*	-20°C (-4°F)	
Maximum Storage Temperature*	60°C (140°F)	

* NOTE. When taken out of storage the generator should be allowed to acclimatize at room temperature for a minimum of 3 hours before operation

Generator Outlets

Curtain Max Flow @ 80 psi	12 L/min (0.42 cfm)	12 L/min (0.42 cfm)
Source Max Flow @ 110 psi	24 L/min (0.85 cfm)	24 L/min (0.85 cfm)
Exhaust Max Flow @ 60 psi	8 L/min (0.28 cfm)	14 L/min (0.49 cfm)
Particles	<0.01µm	
Phthalates	NONE	
Suspended Liquids	NONE	
Gas Outlets	3 x ¼" BSPP	
Drain Outlets	1 x ¼" BSPP	
Pressure Gauges	3	
Start-Up Time	30 minutes	

Electrical Requirements

Voltage	230 VAC ± 10%
Frequency	50/60 Hz
Current	9.5 Amps
Input Connection	C20 Plug
Power Cord (Supplied)	C19 socket to local connection (13A minimum)
Pollution Degree	2
Insulation Category	II

General

Dimensions cm (inches) WxDxH	90 x 73 x 75.3 (35.4 x 28.7 x 29.6)
Generator Weight Kg (lbs)	145 kg (316lb)
Shipping Weight Kg (lbs)	200 kg (441lb)

Unpacking

Although Peak Scientific takes every precaution with safe transit and packaging, it is advisable to fully inspect the unit for any sign of transit damage.

Check 'SHOCKWATCH' and 'TIP-N-TELL' labels for signs of rough handling prior to unpacking

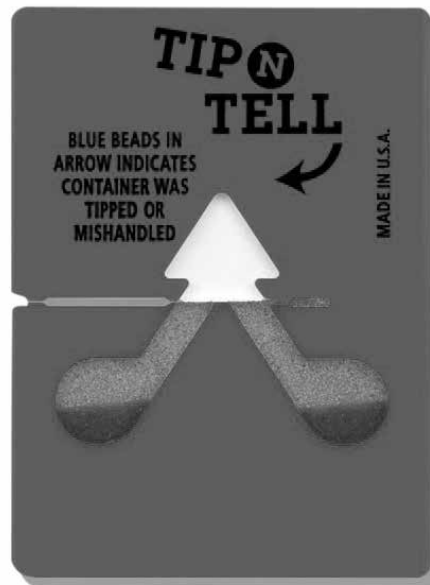

Any damage should be reported immediately to the carrier and Peak Scientific or the Peak Partner from where the unit was purchased.

Follow the unpacking instructions posted on the side of the crate. It will require two people to remove the unit from the shipping crate and to manoeuvre the generator to the desired location.

Please save the product packaging for storage or future shipment of the generator.

Note: Included with the generator is a "Fittings Kit" containing mains power leads for UK, EU & US and also all the required fittings and warranty registration card. Be careful not to discard these with the packaging.

Fittings Kit Contents

Supplied in the Fittings Kit are all the fittings required to connect the generator to the application. The contents of the Fittings Kit are as follows:

1. ¼" Teflon Tubing	4 x 3m
2. 6mm PE Tubing	x 3m
3. ¼" Compression Fitting	x 3
4. 6mm Push Fit Fitting	x 1
5. UK Mains Power Cable	x 1
6. EU Mains Power Cable	x 1
7. US Mains Power Cable 230v	x 1
8. 8mm Hex Key	x 1

All of the generators output ports are located on the output panel at the rear of the unit.

Installation

Generator Environment

The generator is designed for indoor use only. It should be installed adjacent to the application(s) it is supplying. If this is not convenient then the unit can be sited elsewhere, however, consideration should be made of the lengths of pipe runs as pressure drops can result from extended runs of pipe.

Performance of the generator (like all sophisticated equipment) is affected by ambient conditions. Note should also be taken to the proximity of Air Conditioning outlets. These can sometimes give rise to “pockets” of air with high relative humidity. Operation of the unit within such a pocket could adversely affect its performance. Consideration should also be given to the air flow around the unit. It is recommended that an air gap of 75mm (3”) should be maintained down both sides and at the rear of the unit. Please refer to the drawing below for the general dimensions of the unit.

Minimum Operating Ambient Temperature: 5 °C (41 °F)

Maximum Operating Ambient Temperature: 30 °C (86 °F)

Generator Overview

General Dimensions

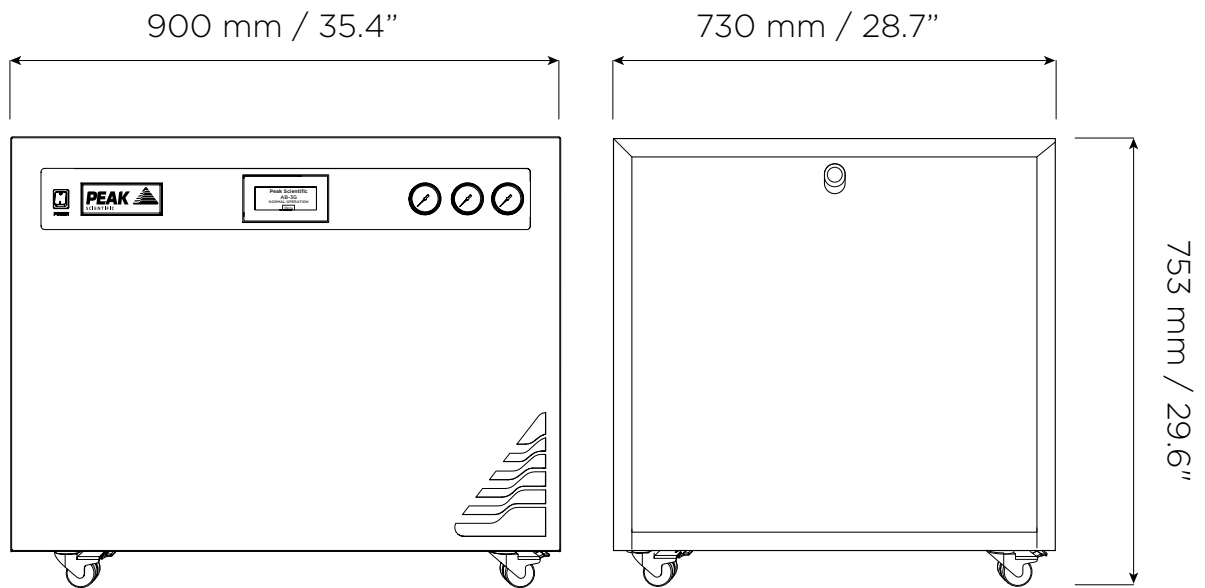

The generator must always be placed on a flat, level surface. Failure to do so will affect the performance of the generator.

Rear Connections

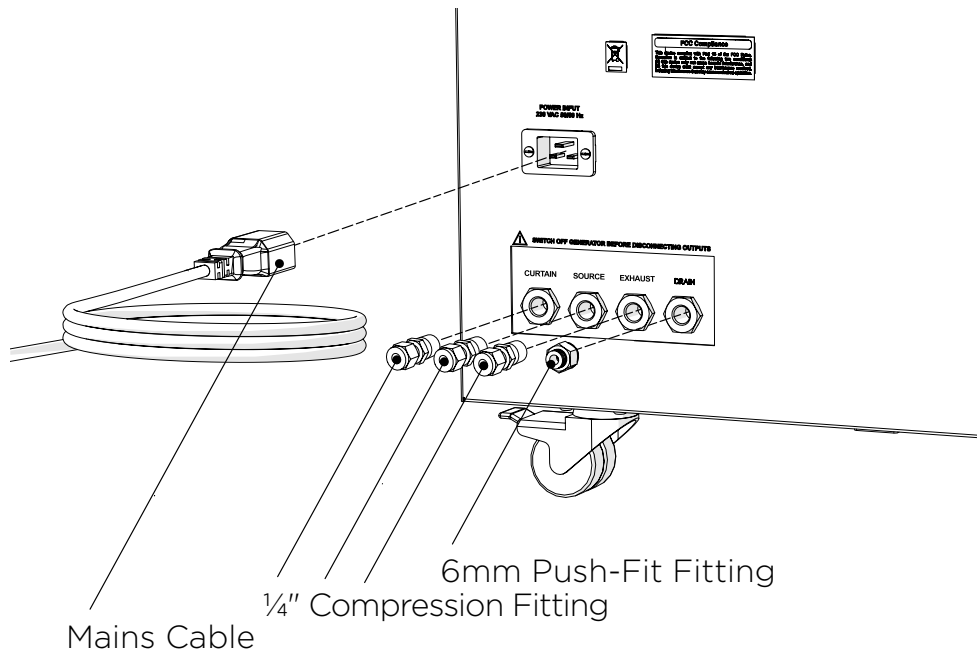

Electrical Connection

Connect the generator to an appropriate 110 or 230 volt single-phase supply, refer to the generator serial plate for input specification and ensure your supply matches the requirements.

If the appropriate power cord is not supplied; a new plug, rated to at least 12 amps, can be fitted by a qualified electrician.



This unit is classified as SAFETY CLASS 1. THIS UNIT MUST BE EARTHED. Before connecting the unit to the mains supply, please check the information on the serial plate. The mains supply must be of the stated AC voltage and frequency.

EARTH/GROUND (E):- Green & Yellow or Green

LIVE (L):- Brown or Black

Neutral (N):- Blue or White

Electrical requirements for 230V generators is 195V - 253V 50/60Hz. For 195V - 219V a 06-3210 Dual Tap Transformer is required.



If the equipment is used in a manner not specified by the manufacturer, the protection provided by the equipment maybe impaired.

Start-Up Sequence

Once connected to the mains supply the generator can now be switched on. Flick the power switch on the front panel of the generator to the on position

The first time the unit is switched on it will ask you to confirm that the transit brackets have been removed. The unit will not start until the user has pressed the confirm button.

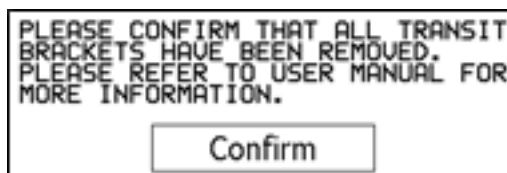

The unit will then start an installation diagnostics sequence. The diagnostics will take approximately 20 minutes to complete. A progress bar is shown to indicate the progress of the tests. This is not an indication of time.

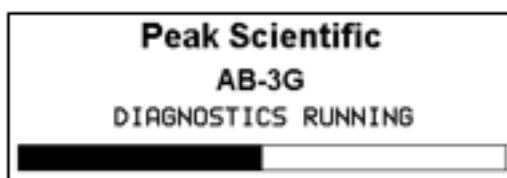

During the diagnostics the user will be asked to confirm that the tubing connected to the drain outlet is secure and that if it is connected to a drain container that it is empty. The diagnostics will be paused until the user presses confirm.

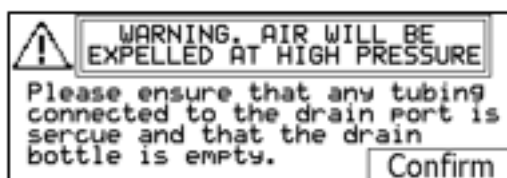

During diagnostics air is expelled through the drain outlet at pressure. Please ensure that the tubing is secure. If a drain bottle is used please ensure that it is empty before carrying out a diagnostics check as water may be sprayed from the container.



The drain bottle should NOT have an air tight seal.



It should be noted that the gas pressures and flows are factory set. The pressures shown on the Generator front panel are in excess of the maximum inlet pressure of the Mass Spectrometer. This is to allow for known pressure drops. These settings have been approved by AB Sciex.



Once the tubes are connected to the appliance, ensure that they are thoroughly checked for being leak-tight. Even the slightest leak in the gas supply between the Generator and the application can lead to a reduction in efficiency, or possible alarm of the Generator.

The diagnostics sequence will only run on subsequent start-ups if there was a problem detected before it was shut down. If no fault had previously been detected and the installation diagnostics has been completed, a start-up screen will appear for 30 seconds to allow the user to initiate a diagnostics check. This is recommended if the unit has been turned off for a long period or the generator has been moved.

Once diagnostics have completed the generator will take a couple of minutes to become ready for use.

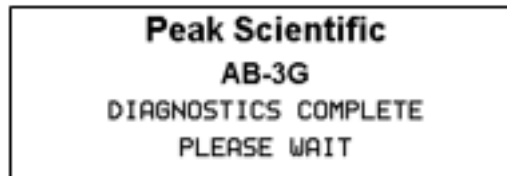

Once pressure is within the normal operating limits the buzzer will sound two short beeps to signify the generator is ready for use. A reminder to register the Generator with Peak Scientific will be displayed.

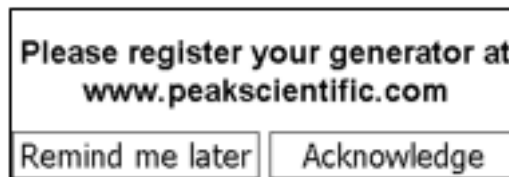

Once you have registered the generator pressing [Acknowledge] will prevent this message appearing again. Pressing [Remind me later] will display the message again in one and a half hours. You can register online at <http://www.peakscientific.com/service-and-support/warranty-registration>

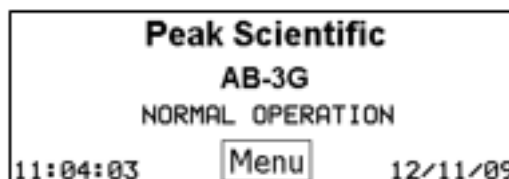

Before the Generator is connected to the Mass Spectrometer the Generator should be operated in isolation (i.e. not connected to the Mass Spectrometer) for thirty minutes after the start up diagnostics have completed. This is to ensure any impurities present are purged from the system. Failure to do this may harm the Mass Spectrometer.

Operating Modes

The generator can operate in a number of modes depending on the gas demand from the Mass Spectrometer and the health of the generator. The operating mode is displayed on the main screen of the HMI. The operating mode will change automatically, no user intervention is required.

Normal Operation

The Genius AB-3G Gas Generators are designed specifically to minimize operator involvement. Given that the systems are installed as described in earlier sections and is serviced in accordance with the specified maintenance recommendations (see Service Requirements), then it should simply be a matter of turning the Generator on when it is required.

The Generator will automatically produce the factory set flow and pressure as detailed in the Technical Specifications.

Standby Mode

The generator will detect when the Mass Spectrometer enters standby mode. Due to the reduced gas demand the Generator controls the compressors differently to help extend compressor life.

It should be noted that even in standby the Mass Spectrometer still consumes a small amount of Nitrogen and Dry Air. This in turn reduces the receiver pressure within the Generator causing the compressors to start up. This is normal in Standby Mode.

The operating mode on the main screen will change to Standby Mode.

High Altitude Mode

High altitude mode allows the Generator to operate easier at high altitude. In this mode both air compressors run together during Normal Operation. Consult with your local Peak Representative before enabling this function.



It should be noted that this will increase the duty on the compressors and reduce time between services. This mode should only be used where required.

The main screen will now display “High Altitude Mode” instead of “Normal Operation”

HMI User menus

The AB-3G's advanced control system employs an easy to navigate menu system to give the user additional information about the Generator. The menu is accessed by pressing the [Menu] button on the main screen.

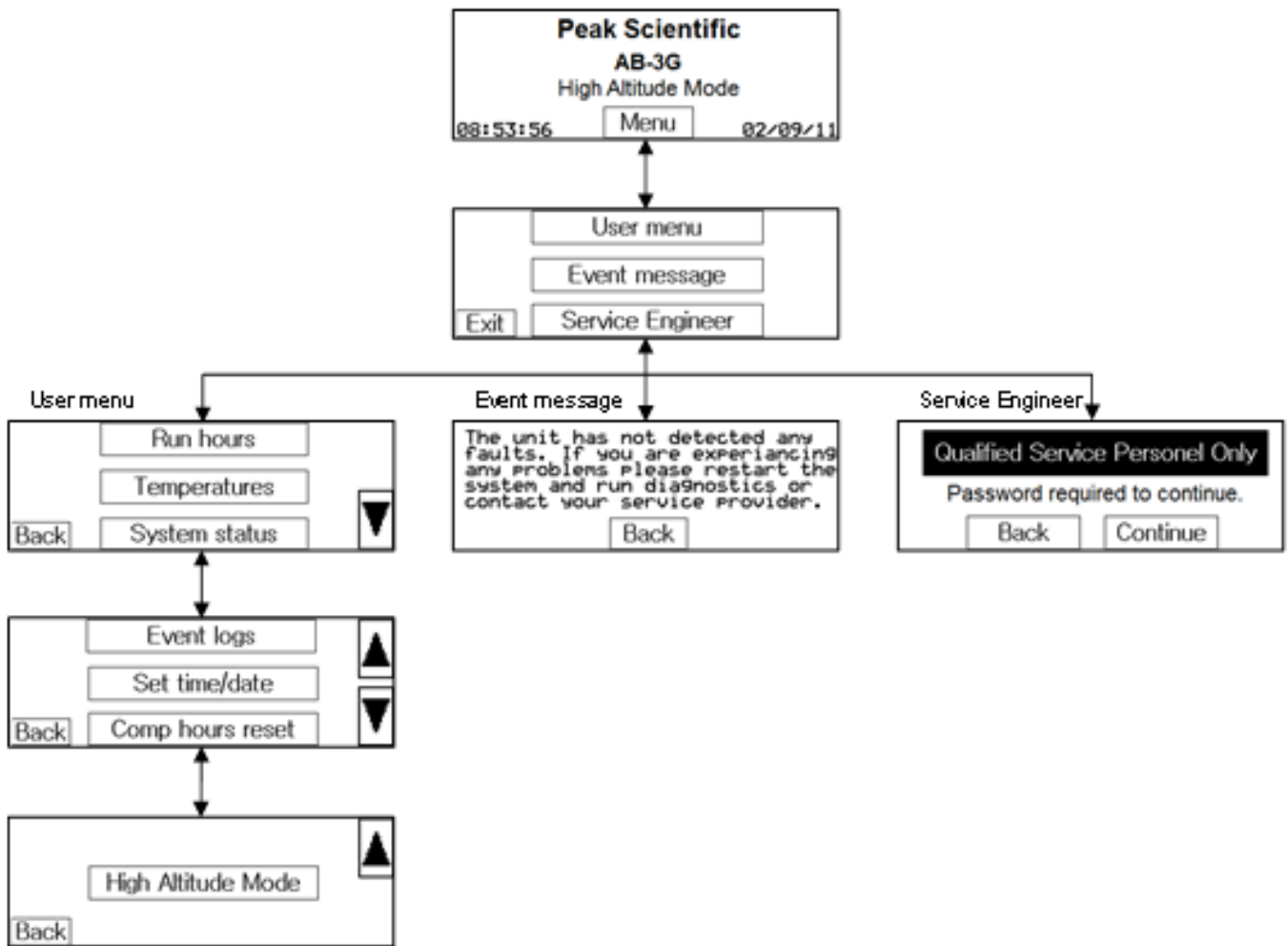

User Menu

The user menu gives access to the following functions

Run hours

Displays:

- Unit on time - The total time the unit has been turned on.
- The date the next annual service is due.
- Compressor run times - The time that each compressor has actually been running.

Temperatures

The AB-3G monitors ambient (room) temperature and the temperature within the compressor cabinet inside the generator as part of the temperature alarm system. The information on this screen is a live reading of these two temperature inputs. The alarm set points can be accessed via this screen also.

System status

The status of each component within the Generator is displayed. This includes the three compressors and all of the solenoid valves used within the system. This can be used should a fault be detected to show which components have failed.

Event logs

The event logs record the date and time of all system events. These are split into two logs

- System Faults
- Temperature alarms

System faults log the error code along with the date and time. Recent error codes should be noted and passed to your service provider if you are reporting a fault. The last twenty faults are logged.

Temperature alarms will record every time a temperature warning or over temperature shutdown occurs. The last ten faults are logged.

Set time/date

The date and time, as displayed on the main screen, is set here. Setting the date and time ensures that any events are correctly logged.

Comp hours reset

When a compressor is serviced or replaced the run hours of the compressor need to be reset here. This screen is password protected. A password will be included in the instruction manual provided with your replacement compressor or compressor service kit.

High Altitude Mode

This allows High Altitude Mode to be enabled or disabled

Event message

This displays details of the current error if either of the fault icons are displayed on the main screen.

Service Engineer

This is a password protected area of the controls. A caution screen is displayed to allow the user to go back to the main menu. Access is only granted to qualified service personnel. Please contact Peak Scientific if you require training.

On Demand Gas

The generator will produce nitrogen on demand. If the application is operating and requires a gas flow, the system it is connected to will supply this to suit the requirements of the application. If the application requirement for gas stops, the system will also stop, once it has reached its upper set limit in the internal storage tanks. If the demand from the application starts again, the system will detect the demand for gas and will automatically start again to suit the demand.

Generator Cycling

The Generator is designed for the internal compressors to cycle. This cycling reduces the duty (run time) on the compressors. The rate at which they cycle will be dependent on the gas required to satisfy the demand of the application. If the application demands the maximum gas flow of the Generator, the compressor duty will be higher, (the rest period in the compressor cycle will be shorter). If the application demand is lower than the maximum gas flow, then the duty on the compressors will decrease, (the rest period in the compressor cycle will be longer). If the Generator is installed in an extreme environment or is subjected to low supply voltage or high altitude the compressors may undergo periods where they do not cycle.

Unusual Operation

If at any time the generator begins to emit excessive noise or vibration, then it should be switched off and you should contact Peak Scientific or the Peak Partner from which the generator has been purchased.

Fault Warning

Should the unit detect a fault, a message will be displayed on the HMI to explain the fault and inform the user of the current status of the machine. There are three levels of fault.

- Minor fault
- Redundancy mode
- System failure
- Temperature alarm
- Run time alarm

A minor fault is shown when one of the valves used during diagnostics has failed. These are set to fail in the normal operating mode therefore the system can function as normal. You should contact your service provider to rectify the problem at your convenience

Redundancy mode is likely to indicate a failed compressor. The unit will continue to run with the remaining two compressors. An intermittent audible alarm will also sound to alert the user. This alarm can be silenced.

A system failure means that the unit can no longer supply gas and will be shut down. An audible alarm will sound constantly to alert the user. This can be silenced.

A temperature alarm is to ensure the generator is not being operated over the specified maximum temperature (30°C). The temperature within the internal compressor cabinet is also monitored to ensure that they are properly cooled. If the Generator is operated above the maximum temperatures then damage can be caused to the internal compressors and the membrane separators.

Run time alarm monitors the length of time that the compressors have been running. If everything is working properly the compressors should cycle regularly. If a compressor has not cycled but is still maintaining pressure the Generator will continue to operate. A run time alarm will generally mean there is a problem with the system which may lead to system failure. Your service provider should be contacted immediately.

Once the fault message has been acknowledged by the user an icon will be displayed on the main screen as a reminder.

Connecting to the application

Once the initial purge run of 30 minutes has completed, and the generator has been running for 1 hour, it is ready to be connected to the application(s).



The pressure in the internal storage tanks must be allowed to dissipate before connecting the generator to the application(s)

Attach the appropriate fittings to the outlets of the generator. Using the tubing supplied, connect the outlets of the generator to the inlets on the application.

If you require more tubing than is supplied please refer to the Tubing Lengths section.



Once the tubing is connected to the application, please ensure that it is thoroughly checked for being leak-tight. Even the slightest leak in the gas supply between the generator and the application can lead to a reduction in efficiency.

Tubing Lengths



The diameter of the tubing which will be connected to the gas outlet is important and is determined by the length of tubing required. Failure to follow these recommendations could lead to pressure between generator and application.

- < 10 meters: Use 6/4 (6mm O/D, 4mm I/D) P.T.F.E. tubing.
- > 10 - 40 meters: Use 10/8 (10mm O/D, 8mm I/D). Tubing and fittings not supplied in the fittings kit.
- > 40 metres: Please contact Peak Scientific with the relevant distance and we will calculate the flow resistance and the tubing size required.

A combination of 6/4 and 10/8 tubing may be used to ensure that there is no large diameter tubing within the lab (i.e. for the first 20 meters from the Generator use 10/8 and the final 10 meters to the application use 6/4 tubing). Keep the connections and bends to a minimum.

The imperial equivalents are: 6/4 = 1/4" O/D, 3/16" I/D.

10/8 = 3/8" O/D, 5/16" I/D.

Service Requirements

Service Schedule

Purchase Interval	Component	Visit
12 Months	Genius AB-3G Annual Maintenance Kit	www.peakscientific.com/ordering

Service Indication

The Generators will display the service icon when a service is due.

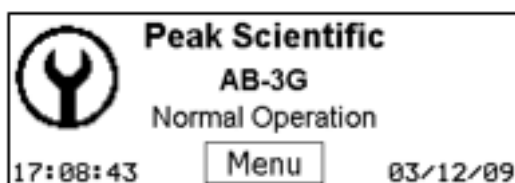

Peak Protected

With Peak Scientific you invest in not only a product but peace of mind. With a network of certified Peak engineers stationed throughout the globe, Peak's rapid response team are never far away and our commitment is to keep your generator running day in, day out, protecting your laboratory workflow.

[Peak Protected] can provide...



Installation
A dedicated Peak engineer will visit your lab to install and setup your generator



Complete plan
Swift response by a Peak Service Engineer within 72 hours & planned preventative maintenance



Premium Protected
Guaranteed rapid on-site response within 24 hours & planned preventative maintenance



IQ/OQ
Certified assurance for applications requiring documented qualification

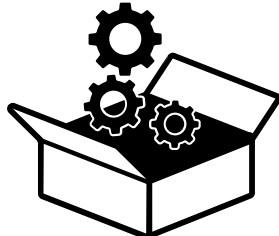

Spares
Genuine Peak parts with express delivery, ensuring optimal performance and lifetime



Technical Support Hotline
Around the clock support by phone or online with our global technical helpdesk

To find out more about protecting your investment visit: www.peakscientific.com/protected

Cleaning

Clean the outside of the generator only using warm soapy water and a clean damp cloth. Ensure all excess fluid is thoroughly removed from the cloth prior to use.



Cleaning should only be undertaken with the power switched off and the power cord removed from the rear of the generator.





Under no circumstances should any solvents or abrasive cleaning solutions be used as these can contain fumes that could be harmful to the generator.



Care should be taken with Leak Detections Liquids.

Troubleshooting

Problem	Possible Solution
<p>The Generator will not switch on and the power switch does not illuminate.</p>	<ul style="list-style-type: none"> • Ensure power cord is plugged into the Generator and that the power socket is turned on. • Check the fuse in the power cord plug. • Contact your service provider. 
<p>The Generator will not switch on but the power switch is illuminated.</p>	<ul style="list-style-type: none"> • Disconnect power cord from the rear of the Generator. Open the left hand panel and check that both circuit breakers are turned on (switch in the up position). Reconnect power cord. • Contact your service provider. 
<p>Compressors are running but pressure is not building.</p>	<ul style="list-style-type: none"> • Check the HMI screen to ensure that diagnostics are not running. The pressure gauges on the front panel will read zero for the majority of the diagnostics run. • Run diagnostics. • Contact your service provider.
<p>The HMI screen says “Standby Mode” but the compressors are still running.</p>	<ul style="list-style-type: none"> • This is normal. When the Mass Spectrometer is in standby it still requires a gas supply, the Generator changes its operation to best cope with this reduced demand.
<p>The mass spec is reporting low pressure.</p>	<ul style="list-style-type: none"> • Contact your service provider.

Go Online or Complete and Return

We know that registering any of your recently purchased products is not the first thing on your mind- but it is very important to both of us. Not all warranties are alike and Peak Scientific stand out against other gas suppliers as we offer a comprehensive, quick response, on-site warranty. This means that in the very unlikely case that your gas generator develops a fault we have rapid support teams on-hand around the world who are able to come to your lab and get you back up and running in no time.

Register for your **comprehensive 12 month on-site warranty** with ease online at www.peakscientific.com/protected.

Alternatively, you can send the completed form to Peak Scientific by post or email at warranty@peakscientific.com.

Go Online or Complete and Return

You can register for your **FREE 12 month Warranty** with ease online at www.peakscientific.com/protected.

Alternatively, you can send the completed form to Peak Scientific by post or email at warranty@peakscientific.com.

Product Warranty Registration			
Contact name			
Email address			
Company			
Address			
City/town			
Postcode			
Country			
Telephone			
Generator serial #			
Model type			
Installation date			
Do you still use an alternative gas solution i.e. cylinders or bulk liquid?	Yes	No	
What gas requirements do you have in your lab?	Hydrogen	Nitrogen	Zero Air

Extend your cover with

Peak Scientific offer comprehensive gas generator after sales support packages. Peak [Protected] aftercare support can guarantee an on-site response within 72 hours*, genuine parts from our ISO9001 approved factory and a 95% first-time fix rate. See our enclosed Peak [Protected] leaflet for further information.

Important!

You have 1 month to register your Peak Scientific product from the date of installation. Once registered the warranty will be honoured for a period of 12 months. If you wish to defer the installation of your generator, you must notify Peak Scientific immediately by emailing warranty@peakscientific.com. For generators that remain unregistered after 1 month from the shipment date, the warranty will be considered active from the date of factory dispatch.

* Complete Plan only

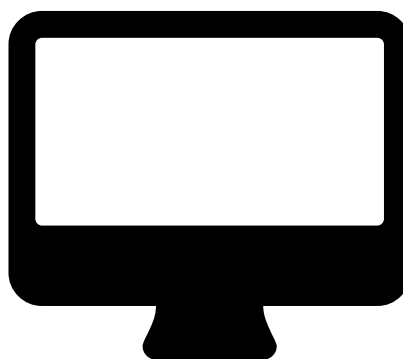

Important!

You have **1 month to register** your Peak Scientific product from the date of installation. Once registered the warranty will be honoured for a period of 12 months. If you wish to defer the installation of your generator, you must notify Peak Scientific immediately by emailing warranty@peakscientific.com. For generators that remain unregistered after 1 month from the shipment date, the warranty will be considered active from the date of factory dispatch.

[**PEAK Protected**]TM

Peak Scientific has highly trained, fully certified Field Service Engineers located in over 20 countries across every continent around the world. This allows us to provide an industry-leading rapid response service to our customers. With [**Peak Protected**], your laboratory's productivity becomes our top priority.

To discuss Peak Protected generator cover and payment options speak to your local Peak Representative or for further information contact: protected@peakscientific.com

Peak Scientific

Fountain Crescent
Inchinnan Business Park
Inchinnan
PA4 9RE
Scotland, UK

Tel: +44 141 812 8100

Fax: +44 141 812 8200

For further information on any of our generator products please contact marketing@peakscientific.com