

Genius 3010/13/20/22

User Manual

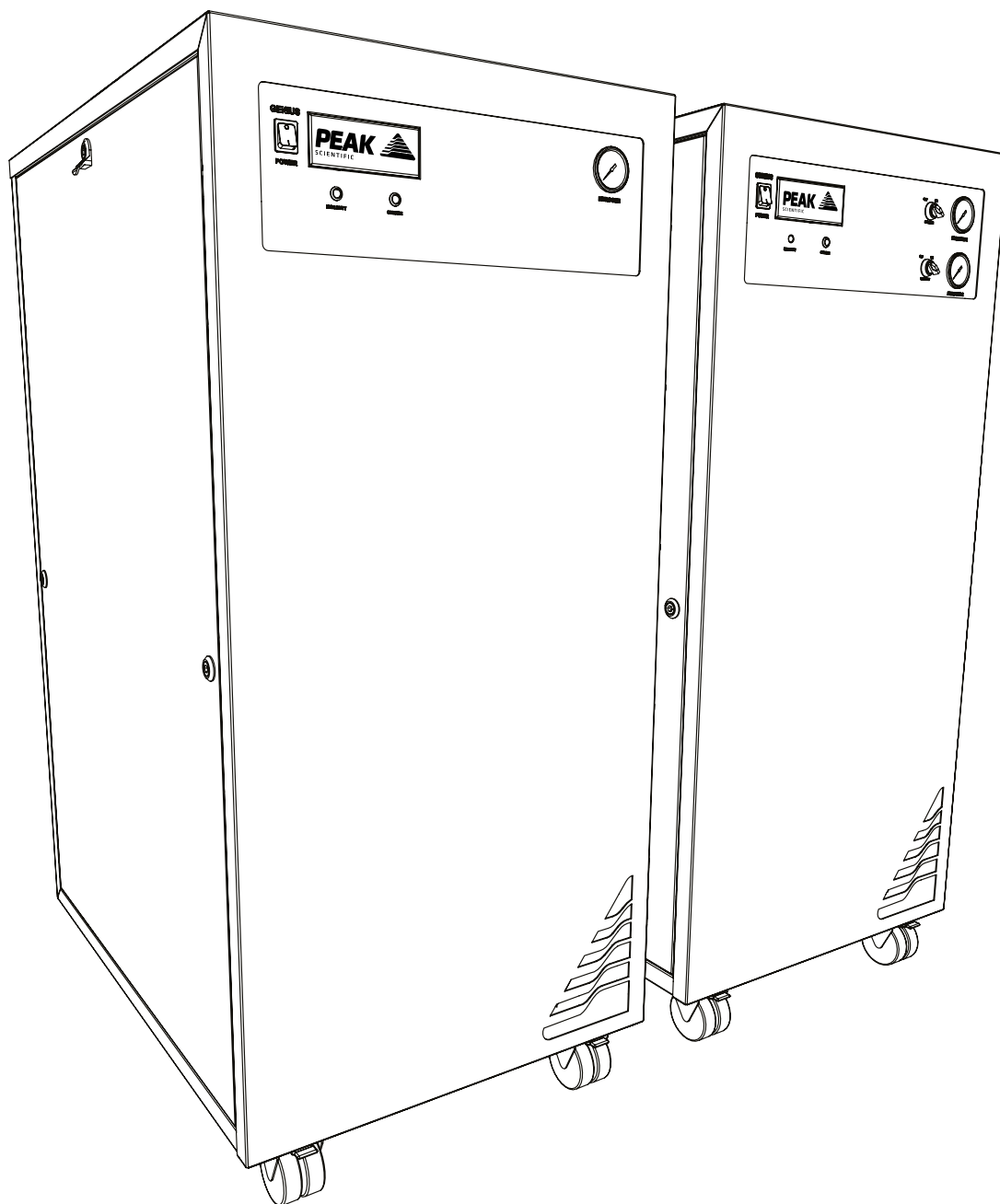

PEAK 
SCIENTIFIC

Contents

Change History	3
How to use this Manual	3
Introduction	4
Warranties and Liabilities	5
Safety Notices	6
Symbols	6
Safety Notice to Users	6
Declaration of Conformity	7
Environmental Declaration	8
Technical Specification	9
Unpacking	13
Fittings Kit Contents	14
Installation	15
Generator Environment	15
3010/3013 General Dimensions	16
3010/3013 Rear Connections	17
3020/3022 General Dimensions	18
3020/3022 Rear Connections	19
Electrical Connection	20
Start-Up Sequence	21
Normal Operation	22
On Demand Gas	22
Generator Cycling	22
Unusual Operation	22
Connecting to the application	23
Tubing Lengths	23
Service Requirements	24
Service Schedule	24
Peak Protected	26
Cleaning	27
Troubleshooting	28

Change History

Rev	Comment	Name	Date
2	3010 Tech Spec Update	Liam Couttie	01/02/2018

How to use this Manual

This manual is intended for end users and has been written as a reference document where you can skip to the relevant information.

Users can refer to the contents page to find the relevant information.

Please review each of the following sections carefully.

Thank you for selecting Peak Scientific to meet your gas generation needs, and should you require any further assistance or support please do not hesitate to contact Peak Scientific or the Peak Partner from which you purchased your generator.

Introduction

The Genius 3010, 3013, 3020 & 3022 have been developed to provide a supply of nitrogen gas for your LC/MS instrument. We've built them with internal air compressors as standard, removing the reliance upon an in-house air supply.

These model provide a source of nitrogen gas with other features including:

- Quiet in operation - Insulated compressor compartment for minimum disruption
- Cool - Minimal heat build-up in the lab
- Intelligent - High duty service indicator
- Mobile - Flexibility to position the generator where required
- Simple installation - Generator designed as a plug and play system
- Economical - More cost effective than any other gas supply method
- Convenient - Gas on demand, no hazards, no need to worry about running out of gas

The Genius 3010, 3013, 3020 & 3022 are based on proven technology, and selectively remove oxygen, moisture and other gases to leave clean, dry, phthalate free nitrogen. Internal air compressors make these units independent from in-house air supplies and fitted castors allow the user to easily position the units in the lab.

To ensure these Generator models meet our high expectations with regards to reliability and performance, we have tested them extensively at our manufacturing plant and with end users around the world to ensure reliability and longevity of the system.

Warranties and Liabilities



1. The Company warrants that it has title to the Goods.
2. Subject to the provisions of this clause the Company warrants that the Goods shall comply in all material respects with any specification referred to in the Order Confirmation (as the same may be amended) and shall, subject thereto, be free from defects in material and workmanship for the lesser of a period of twelve months from the date of delivery or thirteen months from the date of dispatch from the factory.
3. Save as provided in this clause and except where the Goods are sold to a person dealing as a consumer (within the meaning of the Unfair Contract Terms Act 1977) all warranties, conditions or other terms implied by statute or common law are hereby expressly excluded save to the extent they may not be lawfully excluded. When the Goods are sold to a consumer within the meaning of the Unfair Contract Terms Act 1977 their statutory rights are not affected by the provisions of this clause.
4. In the event of the Customer making a claim in respect of any defect in terms of clause 2 hereof the Customer must.
 1. Reasonably satisfy the Company that the Goods have been properly installed, commissioned, stored, serviced and used and without prejudice to the generality of the foregoing that any defect is not the direct or indirect result of lack of repair and/or servicing, incorrect repair and/or servicing, use of wrong materials and/or incorrect spare parts
 2. Allow the company to inspect the Goods and/or any installation and any relevant packaging as and when reasonably required by the Company.
5. Subject to the Company being notified of any defect as is referred to in sub-clause 2 hereof within a reasonable time of it becoming apparent and subject always to the terms of sub-clause 4 hereof, the Company shall, in its option, replace or repair the defective Goods or refund a proportionate part of the Price. The Company shall have no further liability to the Customer (save as mentioned in sub-clause 6 hereof).
6. The Company shall be liable to indemnify the Customer in respect of any claim for death or personal injury to any person in so far as such is attributable to the negligence or breach of duty of the Company or any failure by the Company to comply with the provisions of sub-clause 2 hereof.
7. Save as provided in sub-clause 2 hereof the Company shall not be liable in respect of any claim by the Customer for costs, damages, loss or expenses (whether direct, indirect, consequential or otherwise) or indemnity in any respect howsoever arising including, but not by way of limitation, liability arising in negligence (other than pursuant to clause 6 above) that may be suffered by the Customer or any third party.

Safety Notices

Peak Scientific Instruments cannot anticipate every possible circumstance which may represent a potential hazard. The warnings detailed within this manual refer to the most likely potential hazards, but by definition cannot be all inclusive. If the user employs an operating procedure, item of equipment or a method of working which is not specifically recommended by Peak Scientific, the user must ensure that the equipment will not be damaged or become hazardous to persons or property.

Symbols

This manual uses the following symbols to highlight specific areas important to the safe and proper use of the generator.

 WARNING	A WARNING notice denotes a hazard. It calls attention to an operating procedure, process or similar, which if not correctly performed or adhered to, could cause personal injury or in the worst case death. Do not proceed beyond a WARNING notice until the indicated conditions are fully understood or met.
 CAUTION	A CAUTION notice denotes a hazard. It calls attention to an operating procedure, process or similar, which if not correctly performed or adhered to, could cause damage to the generator or the application. Do not proceed beyond a CAUTION notice until the indicated conditions are fully understood or met.
	Caution, risk of electric shock. Ensure power to the generator has been removed before proceeding.

Safety Notice to Users



These instructions must be read thoroughly and understood before installation and operation of your Peak Generator. Use of the generator in a manner not specified by Peak Scientific MAY impair the SAFETY provided by the equipment.



When handling, operating or carrying out any maintenance, personnel must employ safe engineering practices and observe all relevant local health and safety requirements and regulations. The attention of UK users is drawn to the Health and Safety at Work Act 1974, and the Institute of Electrical Engineers regulations.



If the equipment is used in a manner not specified by the manufacturer, the protection provided by the equipment maybe impaired.

Declaration of Conformity

We Peak Scientific Instruments Ltd.
Of Fountain Crescent, Inchinnan, Renfrewshire, PA4 9RE

Declare that:

Equipment: Nitrogen Gas Generator
Models: Genius 3010, 3013, 3020 & 3022

To which this declaration relates, is in conformity with the applicable EC directives, harmonized standards, and other normative requirements.

- Low Voltage Directive 2015/35/EU
EN 61010-1: 2010 Electrical Equipment for measurement, control and laboratory use.
- Electromagnetic Compatibility Directive 2014/30/EU
EN 61326-1: 2013 Electrical Equipment for measurement, control and laboratory use.
- FCC47 CFR Part 15 Class B
Unintentional radiators; Conducted and Radiated emissions limits.

All evaluation, testing and certification issued by:

Nemko Canada Inc.

303 River Road
Ottawa
Ontario
Canada
K1V 1H2

Signed:  Name: Chris Pugh

Date: 03/02/2017 Position: Chief Technology Officer



Environmental Declaration

We Peak Scientific Instruments Ltd.
Of Fountain Crescent, Inchinnan, Renfrewshire, PA4 9RE

Declare that:

Equipment: Nitrogen Gas Generator

Models: Genius 3010, 3013, 3020 & 3022

Is fully compliant with the following Directives

- 2012/19/EU WEEE (Waste of Electrical and Electronic Equipment)
- 2011/65/EU RoHS 2 (Restriction of Hazardous Substance)

Peak Scientific Instruments Ltd fully complies with its obligations towards the European WEEE (Waste of Electrical and Electronic Equipment) Directive 2012/19/EU. These obligations are being met within the B2B compliance group.

Peak Scientific Instruments Ltd has developed all reasonable 'due diligence' controls to ensure that our products comply with the principles and requirements of the European recast RoHS (Restriction of Hazardous Substances) Directive 2011/65/EU. Similar directives in the United States and China, for example, have also been captured within this program.

Where a specific certificate of compliance is required, this can be requested, on a product serial number basis, directly from Peak Scientific Instruments Ltd, by contacting us through our website on www.peakscientific.com

Signed:  Name: Chris Pugh

Date: 10/06/2015 Position: Engineering & Operations Director



Technical Specification

Genius 3010

Environment

Minimum Operating Ambient Temperature	5°C (41°F)
Maximum Operating Ambient Temperature	35°C (95°F)
Maximum Altitude	2000 m
Maximum Relative Humidity	80% Non-Condensing
Minimum Storage Temperature*	-20°C (-4°F)
Maximum Storage Temperature*	60°C (140°F)

Generator Outlets

Maximum Gas Output Pressure	6.9 bar (100 psi)
Maximum Outlet Flow Rate	64 L/min (2.26 cfm)
Start-Up Time	30 mins
Particles	<0.01µm
Phthalates	NONE
Suspended Liquids	NONE
Gas Outlets	1 x ¼" BSPP
Drain Outlets	1 x ¼" BSPP
Pressure Gauges	1

Electrical Requirements

Voltage	230 VAC ± 10%
Frequency	50/60 Hz
Current	12 Amps
Input Connection	C20 Plug
Power Cord (Supplied)	C19 socket to local connection (13A minimum)
Pollution Degree	2
Insulation Category	II

General

Dimensions cm (inches) WxDxH	60 x 85 x 132.2 (23.6 x 33.5 x 52.0)
Generator Weight Kg (lbs)	168.5 kg (371 lb)
Shipping Weight Kg (lbs)	249 kg (548 lb)

Technical Specification

Genius 3013

Environment

Minimum Operating Ambient Temperature	5°C (41°F)
Maximum Operating Ambient Temperature	35°C (95°F)
Maximum Altitude	2000 m
Maximum Relative Humidity	80% Non-Condensing
Minimum Storage Temperature*	-20°C (-4°F)
Maximum Storage Temperature*	60°C (140°F)

Generator Outlets

Maximum Gas Output Pressure	6.9 bar (100 psi)
Maximum Outlet Flow Rate	64 L/min (2.26 cfm)
Chip Cube Mode	increased O ₂ content to 10%
Start-Up Time	30 mins
Particles	<0.01µm
Phthalates	NONE
Suspended Liquids	NONE
Gas Outlets	1 x ¼" BSPP
Drain Outlets	1 x ¼" BSPP
Pressure Gauges	1

Electrical Requirements

Voltage	230 VAC ± 10%
Frequency	50/60 Hz
Current	12 Amps
Input Connection	C20 Plug
Power Cord (Supplied)	C19 socket to local connection (13A minimum)
Pollution Degree	2
Insulation Category	II

General

Dimensions cm (inches) WxDxH	60 x 85 x 132.2 (23.6 x 33.5 x 52.0)
Generator Weight Kg (lbs)	189 kg (417lb)
Shipping Weight Kg (lbs)	265.5 kg (585lb)

Technical Specification

Genius 3020

Environment

Minimum Operating Ambient Temperature	5°C (41°F)
Maximum Operating Ambient Temperature	35°C (95°F)
Maximum Altitude	2000 m
Maximum Relative Humidity	80% Non-Condensing
Minimum Storage Temperature*	-20°C (-4°F)
Maximum Storage Temperature*	60°C (140°F)

Generator Outlets

Maximum Gas Output Pressure	2 x independant outlet of 6.9 bar (100 psi)
Maximum Outlet Flow Rate	2 x independant outlet of 32 L/min (1.13 cfm)
Start-Up Time	30 mins
Particles	<0.01µm
Phthalates	NONE
Suspended Liquids	NONE
Gas Outlets	2 x ¼" BSPP
Drain Outlets	1 x ¼" BSPP
Pressure Gauges	2

Electrical Requirements

Voltage	230 VAC ± 10%
Frequency	50/60 Hz
Current	12 Amps
Input Connection	C20 Plug
Power Cord (Supplied)	C19 socket to local connection (13A minimum)
Pollution Degree	2
Insulation Category	II

General

Dimensions cm (inches) WxDxH	60 x 85 x 132.2 (23.6 x 33.5 x 52.0)
Generator Weight Kg (lbs)	189 kg (417lb)
Shipping Weight Kg (lbs)	265.5 kg (585lb)

Technical Specification

Genius 3022

Environment

Minimum Operating Ambient Temperature	5°C (41°F)
Maximum Operating Ambient Temperature	35°C (95°F)
Maximum Altitude	2000 m
Maximum Relative Humidity	80% Non-Condensing
Minimum Storage Temperature*	-20°C (-4°F)
Maximum Storage Temperature*	60°C (140°F)

Generator Outlets

Maximum Gas Output Pressure	2 x independant outlet of 8.1 bar (116 psi)
Maximum Outlet Flow Rate	2 x independant outlet of 32 L/min (1.13 cfm)
Start-Up Time	30 mins
Particles	<0.01µm
Phthalates	NONE
Suspended Liquids	NONE
Gas Outlets	2 x ¼" BSPP
Drain Outlets	1 x ¼" BSPP
Pressure Gauges	2

Electrical Requirements

Voltage	230 VAC ± 10%
Frequency	50/60 Hz
Current	12 Amps
Input Connection	C20 Plug
Power Cord (Supplied)	C19 socket to local connection (13A minimum)
Pollution Degree	2
Insulation Category	II

General

Dimensions cm (inches) WxDxH	60 x 85 x 132.2 (23.6 x 33.5 x 52.0)
Generator Weight Kg (lbs)	189 kg (417lb)
Shipping Weight Kg (lbs)	265.5 kg (585lb)

Unpacking

Although Peak Scientific takes every precaution with safe transit and packaging, it is advisable to fully inspect the unit for any sign of transit damage.

Check 'SHOCKWATCH' and 'TIP-N-TELL' labels for signs of rough handling prior to unpacking

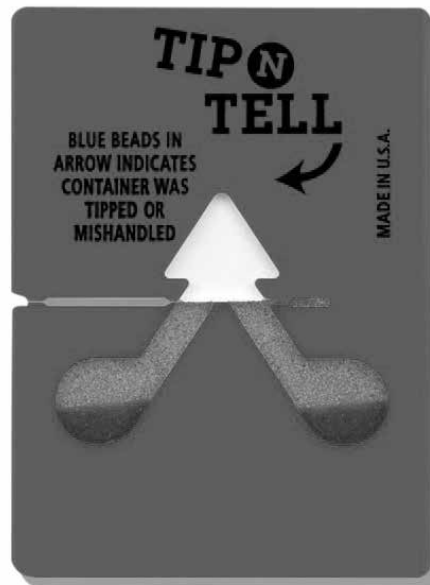

Any damage should be reported immediately to the carrier and Peak Scientific or the Peak Partner from where the unit was purchased.

Follow the unpacking instructions posted on the side of the crate. It will require two people to remove the unit from the shipping crate and to manoeuvre the generator to the desired location.

Please save the product packaging for storage or future shipment of the generator.

Note: Included with the generator is a "Fittings Kit" containing mains power leads for UK, EU & US and also all the required fittings and warranty registration card. Be careful not to discard these with the packaging.

Fittings Kit Contents

Supplied in the Fittings Kit are all the fittings required to connect the generator to the application. The contents of the Fittings Kit are as follows:

1. 6mm Teflon Tubing	x 3m*
2. ¼" Teflon Tubing	x 3m*
3. 6mm PE Tubing	x 3m
4. ¼" Compression Fitting	x 1**
5. 6mm Push Fit Fitting	x 2**
6. Flow Control Silencer	x 1***
7. UK Mains Power Cable	x 1
8. EU Mains Power Cable	x 1
9. US Mains Power Cable 230v	x 1
10. 8mm Hex Key	x 1

* x6m in Genius 3020/22

** x3 in Genius 3020/22

*** x2 in Genius 3020/22

All of the generators output ports are located on the output panel at the rear of the unit.

Installation

Generator Environment

The generator is designed for indoor use only. It should be installed adjacent to the application(s) it is supplying. If this is not convenient then the unit can be sited elsewhere, however, consideration should be made of the lengths of pipe runs as pressure drops can result from extended runs of pipe.

Performance of the generator (like all sophisticated equipment) is affected by ambient conditions. Note should also be taken to the proximity of Air Conditioning outlets. These can sometimes give rise to “pockets” of air with high relative humidity. Operation of the unit within such a pocket could adversely affect its performance. Consideration should also be given to the air flow around the unit. It is recommended that an air gap of 75mm (3”) should be maintained down both sides and at the rear of the unit. Please refer to the drawing below for the general dimensions of the unit.

Minimum Operating Ambient Temperature: 5 °C (41 °F)

Maximum Operating Ambient Temperature: 35 °C (95 °F)

Generator Overview

General Dimensions

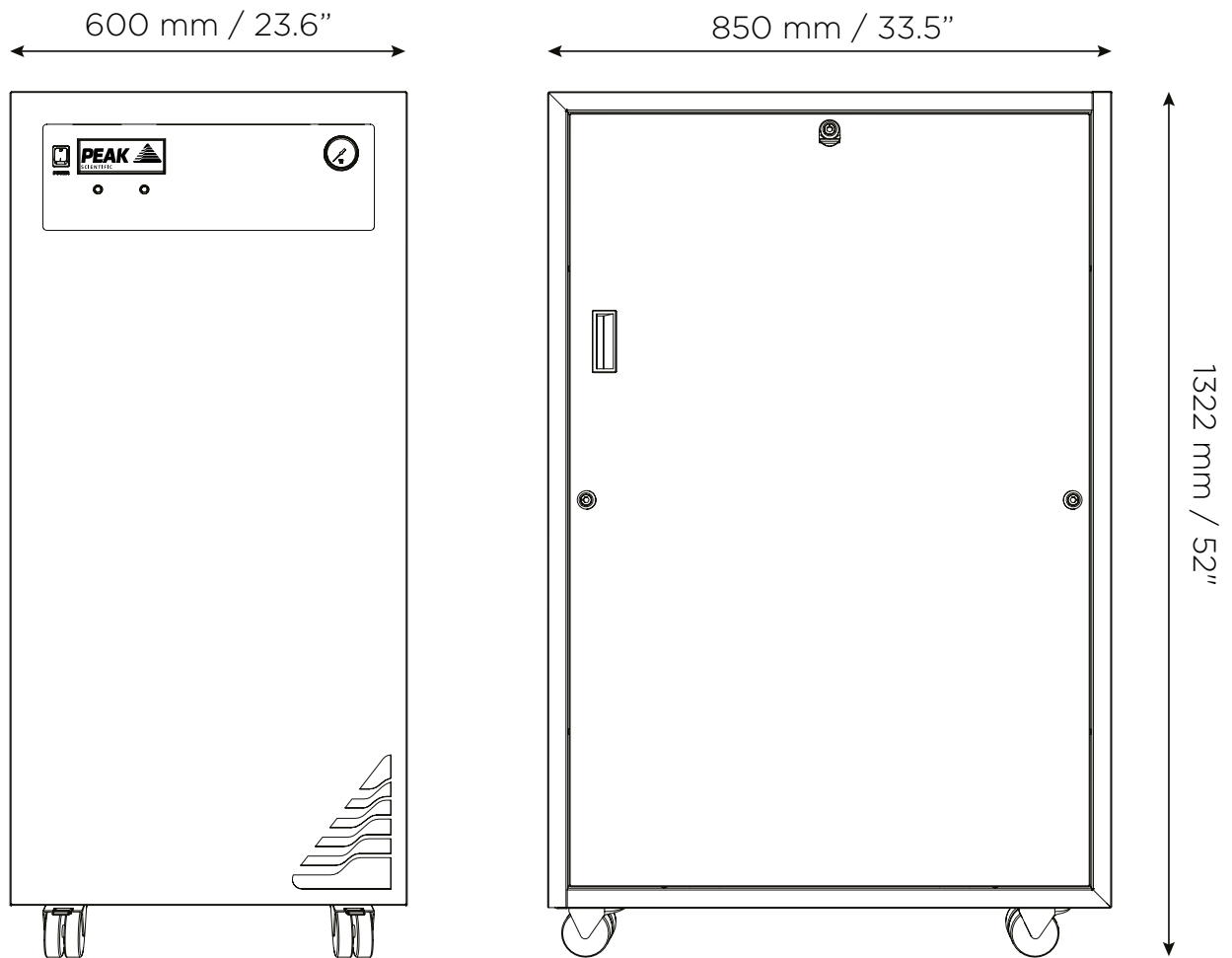

The generator must always be placed on a flat, level surface. Failure to do so will affect the performance of the generator.

3010/3013 Rear Connections

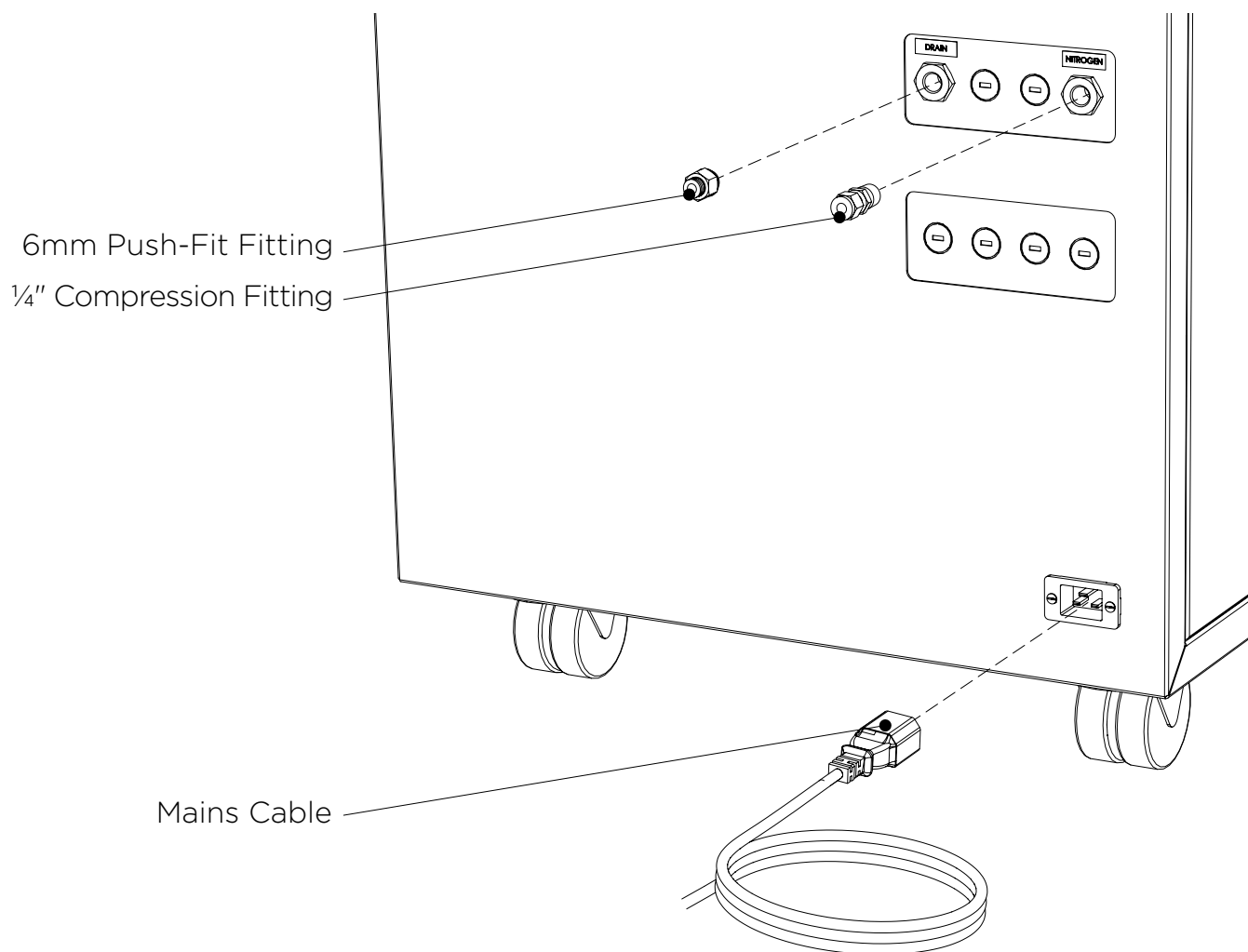

3020/3022 Rear Connections

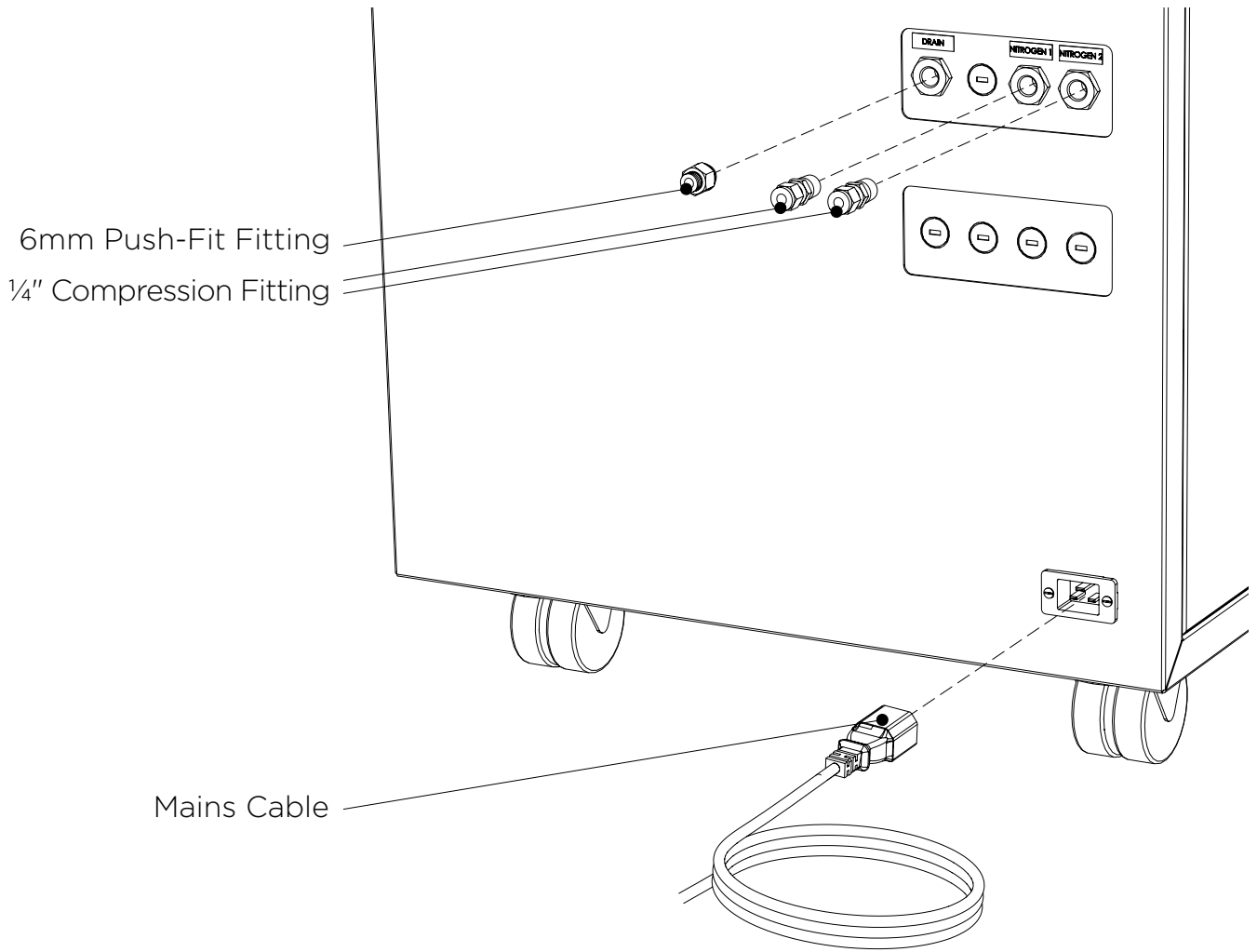

Electrical Connection

Connect the generator to an appropriate 110 or 230 volt single-phase supply, refer to the generator serial plate for input specification and ensure your supply matches the requirements.

If the appropriate power cord is not supplied; a new plug, rated to at least 12 amps, can be fitted by a qualified electrician.



This unit is classified as SAFETY CLASS 1. THIS UNIT MUST BE EARTHED. Before connecting the unit to the mains supply, please check the information on the serial plate. The mains supply must be of the stated AC voltage and frequency.

EARTH/GROUND (E):- Green & Yellow or Green

LIVE (L):- Brown or Black

Neutral (N):- Blue or White

Electrical requirements for 230V generators is 195V - 253V 50/60Hz. For 195V - 219V a 06-3210 Dual Tap Transformer is required.



If the equipment is used in a manner not specified by the manufacturer, the protection provided by the equipment maybe impaired.

Start-Up Sequence



Before the Generator is connected to the application, the Generator should be operated in isolation (i.e. not connected to the application) for thirty minutes. This is to ensure any impurities present are purged from the system. Failure to do this may harm the application.

Before re-connecting the Generator to the mains and switching it on for the isolation run, it is necessary to fit the silencers (supplied in the fittings kit) to the outlet ports of the output panel as shown below.

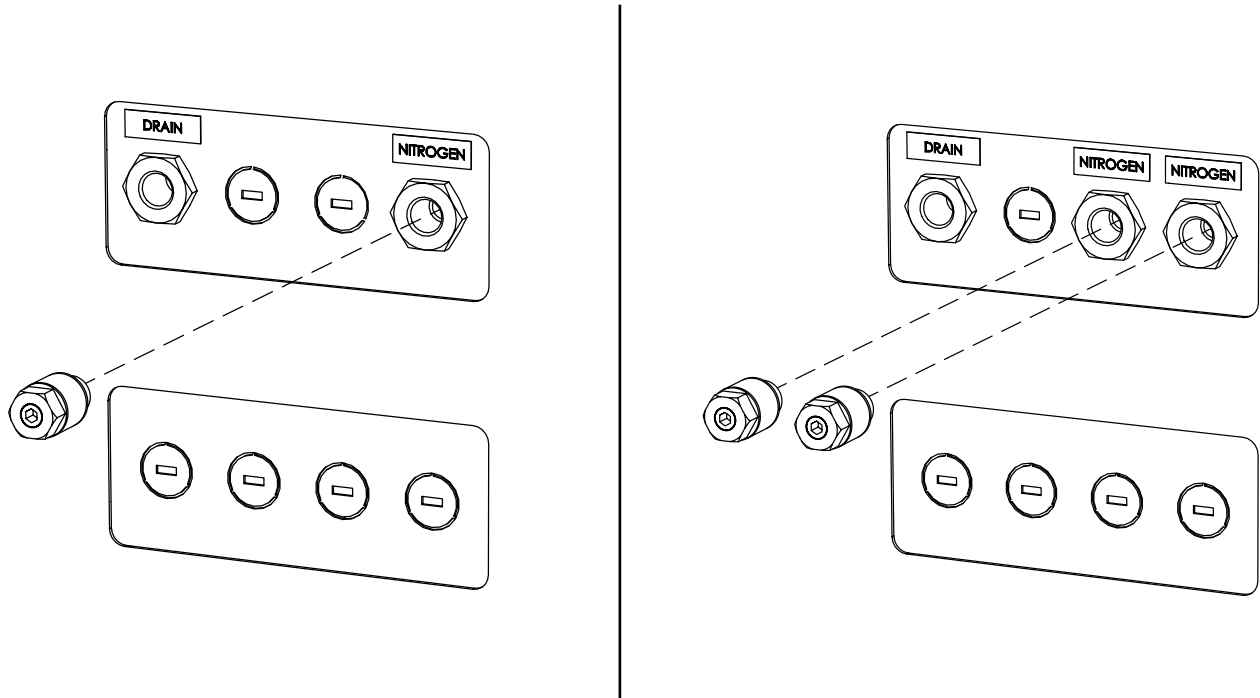

Once this is done, the Generator can be re-connected to the mains and switched on.

Pressure will start to build in the internal storage tanks which can be monitored by watching the output pressure gauges on the front panel. This will climb to the factory set pressure as noted in the specifications.

Once this pressure is reached, the compressors will continue to run until the internal tank upper pressure limit is reached and the compressor has run for a period of at least two and a half minutes.

The compressors will then rest until the internal tank lower pressure limits is reached. Once this limit is reached the compressors will switch back on again. This compressor cycling is normal and will continue throughout the operation of the Generator.

When the system has been operated for a period of 30 minutes, all the internal pipe-work and storage tanks will have been purged with nitrogen.

Once purged, and the tubes can be connected at the rear of the unit. The generator should be allowed to run for 1 hour to allow the gas to reach purity.

Normal Operation

The Genius 3010/3013/3020 & 3022 Gas Generators are designed specifically to minimize operator involvement. Given that the systems are installed as described in earlier sections and is serviced in accordance with the specified maintenance recommendations (see Service Requirements), then it should simply be a matter of turning the Generator on when it is required.

The Generator will automatically produce the factory set flow and pressure as detailed in the Technical Specifications.

On Demand Gas

The generator will produce nitrogen on demand. If the application is operating and requires a gas flow, the system it is connected to will supply this to suit the requirements of the application. If the application requirement for gas stops, the system will also stop, once it has reached its upper set limit in the internal storage tanks. If the demand from the application starts again, the system will detect the demand for gas and will automatically start again to suit the demand.

Generator Cycling

The Generator is designed for the internal compressors to cycle. This cycling reduces the duty (run time) on the compressors. The rate at which they cycle will be dependent on the gas required to satisfy the demand of the application. If the application demands the maximum gas flow of the Generator, the compressor duty will be higher, (the rest period in the compressor cycle will be shorter). If the application demand is lower than the maximum gas flow, then the duty on the compressors will decrease, (the rest period in the compressor cycle will be longer). If the Generator is installed in an extreme environment or is subjected to low supply voltage or high altitude the compressors may undergo periods where they do not cycle.

Unusual Operation

If at any time the generator begins to emit excessive noise or vibration, then it should be switched off and you should contact Peak Scientific or the Peak Partner from which the generator has been purchased.

Connecting to the application

Once the initial purge run of 30 minutes has completed, and the generator has been running for 1 hour, it is ready to be connected to the application(s).



The pressure in the internal storage tanks must be allowed to dissipate before connecting the generator to the application(s)

Attach the appropriate fittings to the outlets of the generator. Using the tubing supplied, connect the outlets of the generator to the inlets on the application.

If you require more tubing than is supplied please refer to the Tubing Lengths section.



Once the tubing is connected to the application, please ensure that it is thoroughly checked for being leak-tight. Even the slightest leak in the gas supply between the generator and the application can lead to a reduction in efficiency.

Tubing Lengths



The diameter of the tubing which will be connected to the gas outlet is important and is determined by the length of tubing required. Failure to follow these recommendations could lead to pressure between generator and application.

- < 10 meters: Use 6/4 (6mm O/D, 4mm I/D) P.T.F.E. tubing.
- > 10 - 40 meters: Use 10/8 (10mm O/D, 8mm I/D). Tubing and fittings not supplied in the fittings kit.
- > 40 metres: Please contact Peak Scientific with the relevant distance and we will calculate the flow resistance and the tubing size required.

A combination of 6/4 and 10/8 tubing may be used to ensure that there is no large diameter tubing within the lab (i.e. for the first 20 meters from the Generator use 10/8 and the final 10 meters to the application use 6/4 tubing). Keep the connections and bends to a minimum.

The imperial equivalents are: 6/4 = 1/4" O/D, 3/16" I/D.

10/8 = 3/8" O/D, 5/16" I/D.

Service Requirements

Service Schedule

Purchase Interval	Component	Visit
12 Months	Genius 3010/13 Annual Maintenance Kit (Pre March '14 Manufactured Generators)	www.peakscientific.com/ordering
	Genius 3010/13 Annual Maintenance Kit (Post March '14 Manufactured Generators)	
	Genius 3020/22 Annual Maintenance Kit (Pre March '14 Manufactured Generators)	
	Genius 3020/22 Annual Maintenance Kit (Post March '14 Manufactured Generators)	
Compressor Assembly	Compressor Assembly (Pre March '14 Manufactured Generators)	
	Compressor Assembly (Post March '14 Manufactured Generators)	

* Compressors can be re-fitted as an alternative to replacement up to a maximum of 3 times, this is a more cost effective solution, however a degree of technical expertise is required and can be time consuming. Please contact your service provider for more information.

Service Indication

The Generators have the following Service Indication Stages:-

Stage 1

Once either compressor requires a service the LED indicator (yellow) on the front of the Generator will illuminate.

This is to make the user aware that a service of the Generator is due and should be planned at the earliest convenience. The Generator will continue to operate as normal with the LED on.

Stage 2

If the service is not completed the Generator will continue to run. After 2 weeks, the service LED indicator (yellow) will start to flash.

This is to make the user aware that the service of the Generator is now overdue and must be completed immediately to ensure the continuous trouble free operation of the Generator.

Service Indication Reset

Once the service has been completed the Service Indication LED can be reset in the main control PLC. This will be performed by the Peak Service Engineer or trained service representative that completes the service operation.

High Duty Indication

The Genius 3010/3013/3020 & 3022 have a 'HIGH DUTY' indicator on the front panel. This indicator monitors the running condition of the internal compressors and

illuminates when they have been operating continually for a period of 8 hours.

There are a number of extreme conditions that can affect the duty cycling of the compressors inside the generator. These extremes include high ambient temperatures, low supply voltages, a high flow requirement and locations of high altitude. Any one of these or a combination of a number of these extremes can be evident in a customer site.

While the generator is designed to operate fully in these conditions it should be noted that the effect of these extremes can force the compressors to run continually. The compressors are fully capable of running continually with no detrimental effect.

High Duty Indication Reset

If the compressors have been operating continually for a period of 8 hours the indicator light will be illuminated. Once the compressors return to a cycling mode the indicator light will automatically switch off. There is no manual intervention required.

Indication of Fault

In most installations the 'HIGH DUTY' indicator will never be illuminated. If your Genius 3010/3013/3020 & 3022 Generator has been operating for a significant period of time, then suddenly develops a 'HIGH DUTY' indication with no apparent change in environmental conditions or flow requirements, it may be indicative of a problem with the system such as an external leak or imminent compressor failure.

If this is the case you should contact Peak Scientific or your service provider.

It should be noted that the Generator will continue to operate so long as it can maintain pressure during this indication.

Peak Protected

With Peak Scientific you invest in not only a product but peace of mind. With a network of certified Peak engineers stationed throughout the globe, Peak's rapid response team are never far away and our commitment is to keep your generator running day in, day out, protecting your laboratory workflow.

[Peak Protected] can provide...



Installation
A dedicated Peak engineer will visit your lab to install and setup your generator



Complete plan
Swift response by a Peak Service Engineer within 72 hours & planned preventative maintenance



Premium Protected
Guaranteed rapid on-site response within 24 hours & planned preventative maintenance



IQ/OQ
Certified assurance for applications requiring documented qualification

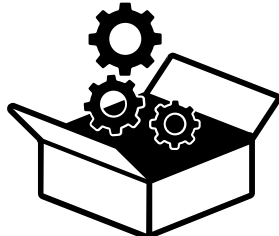

Spares
Genuine Peak parts with express delivery, ensuring optimal performance and lifetime



Technical Support Hotline
Around the clock support by phone or online with our global technical helpdesk

To find out more about protecting your investment visit: www.peakscientific.com/protected

Cleaning

Clean the outside of the generator only using warm soapy water and a clean damp cloth. Ensure all excess fluid is thoroughly removed from the cloth prior to use.



Cleaning should only be undertaken with the power switched off and the power cord removed from the rear of the generator.





Under no circumstances should any solvents or abrasive cleaning solutions be used as these can contain fumes that could be harmful to the generator.



Care should be taken with Leak Detections Liquids.

Troubleshooting

Problem	Possible Solution
<p>The Generator will not switch on and the power switch does not illuminate.</p>	<ul style="list-style-type: none"> • Ensure power cord is plugged into the Generator and that the power socket is turned on. • Check the fuse in the power cord plug. • Contact your service provider. 
<p>The Generator will not switch on but the power switch is illuminated.</p>	<ul style="list-style-type: none"> • Disconnect power cord from the rear of the Generator. Open the left hand panel and check that both circuit breakers are turned on (switch in the up position). Reconnect power cord. • Contact your service provider. 
<p>Compressors are running but pressure is not building.</p>	<ul style="list-style-type: none"> • Check pressure gauges are showing normal pressure. • Contact your service provider.
<p>The mass spec is reporting low pressure.</p>	<ul style="list-style-type: none"> • Contact your service provider.
<p>Yellow “SERVICE” LED on front panel is on constantly.</p>	<ul style="list-style-type: none"> • Annual service is due. Contact your service provider. • Refer to Service Indication section of this manual for further information.
<p>*Yellow “SERVICE” LED on front panel is flashing.</p>	<ul style="list-style-type: none"> • Annual service is overdue. Contact your service provider urgently. • Refer to Service Indication section of this manual for further information.
<p>Yellow “HIGH DUTY” LED on front panel is on constantly.</p>	<ul style="list-style-type: none"> • A compressor(s) has not cycled for a period of 8 hours. Refer to the High Duty Indication section of this manual. • Ensure ambient temperatures are within the specification. • Ensure there are no leaks between the Generator and the mass spec.

Go Online or Complete and Return

We know that registering any of your recently purchased products is not the first thing on your mind- but it is very important to both of us. Not all warranties are alike and Peak Scientific stand out against other gas suppliers as we offer a comprehensive, quick response, on-site warranty. This means that in the very unlikely case that your gas generator develops a fault we have rapid support teams on-hand around the world who are able to come to your lab and get you back up and running in no time.

Register for your **comprehensive 12 month on-site warranty** with ease online at www.peakscientific.com/protected.

Alternatively, you can send the completed form to Peak Scientific by post or email at warranty@peakscientific.com.

Go Online or Complete and Return

You can register for your **FREE 12 month Warranty** with ease online at www.peakscientific.com/protected.

Alternatively, you can send the completed form to Peak Scientific by post or email at warranty@peakscientific.com.

Product Warranty Registration			
Contact name			
Email address			
Company			
Address			
City/town			
Postcode			
Country			
Telephone			
Generator serial #			
Model type			
Installation date			
Do you still use an alternative gas solution i.e. cylinders or bulk liquid?	Yes	No	
What gas requirements do you have in your lab?	Hydrogen	Nitrogen	Zero Air

Extend your cover with

Peak Scientific offer comprehensive gas generator after sales support packages. Peak [Protected] aftercare support can guarantee an on-site response within 72 hours*, genuine parts from our ISO9001 approved factory and a 95% first-time fix rate. See our enclosed Peak [Protected] leaflet for further information.

Important!

You have 1 month to register your Peak Scientific product from the date of installation. Once registered the warranty will be honoured for a period of 12 months. If you wish to defer the installation of your generator, you must notify Peak Scientific immediately by emailing warranty@peakscientific.com. For generators that remain unregistered after 1 month from the shipment date, the warranty will be considered active from the date of factory dispatch.

* Complete Plan only

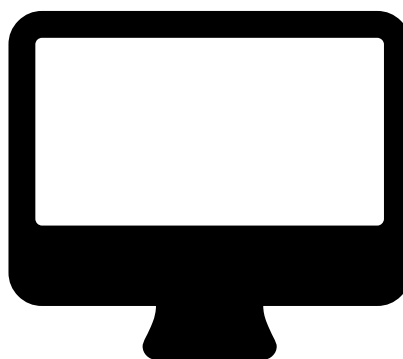

Important!

You have **1 month to register** your Peak Scientific product from the date of installation. Once registered the warranty will be honoured for a period of 12 months. If you wish to defer the installation of your generator, you must notify Peak Scientific immediately by emailing warranty@peakscientific.com. For generators that remain unregistered after 1 month from the shipment date, the warranty will be considered active from the date of factory dispatch.

[**PEAK Protected**]TM

Peak Scientific has highly trained, fully certified Field Service Engineers located in over 20 countries across every continent around the world. This allows us to provide an industry-leading rapid response service to our customers. With [**Peak Protected**], your laboratory's productivity becomes our top priority.

To discuss Peak Protected generator cover and payment options speak to your local Peak Representative or for further information contact: protected@peakscientific.com

Peak Scientific

Fountain Crescent
Inchinnan Business Park
Inchinnan
PA4 9RE
Scotland, UK

Tel: +44 141 812 8100

Fax: +44 141 812 8200

For further information on any of our generator products please contact marketing@peakscientific.com

