

# 946 Portable VA Analyzer



2.946.00x0

Manual  
8.946.8003EN





Metrohm AG  
CH-9100 Herisau  
Switzerland  
Phone +41 71 353 85 85  
Fax +41 71 353 89 01  
info@metrohm.com  
www.metrohm.com

# **946 Portable VA Analyzer**

**2.946.00x0**

1.0

**Manual**

Technical Communication  
Metrohm AG  
CH-9100 Herisau  
techcom@metrohm.com

This documentation is protected by copyright. All rights reserved.

This documentation has been prepared with great care. However, errors can never be entirely ruled out. Please send comments regarding possible errors to the address above.

# Table of contents

<b>1</b>	<b>Introduction</b>	<b>1</b>
1.1	Instrument description .....	1
1.2	Intended use .....	1
1.3	Safety instructions .....	2
1.3.1	General notes on safety .....	2
1.3.2	Electrical safety .....	2
1.3.3	Recycling and disposal .....	3
1.4	Symbols and conventions .....	3
<b>2</b>	<b>Overview of the instrument</b>	<b>5</b>
2.1	Potentiostat .....	5
2.2	Measuring stand scTRACE Gold .....	6
2.3	Measuring stand SPE .....	7
<b>3</b>	<b>Overview of the software</b>	<b>9</b>
<b>4</b>	<b>Installation</b>	<b>14</b>
4.1	Unpacking and inspecting the instrument .....	14
4.1.1	Packaging .....	14
4.1.2	Checks .....	14
4.1.3	Operation site .....	14
4.2	Hardware installation .....	15
4.2.1	Stirrer .....	15
4.2.2	scTRACE Gold electrode .....	15
4.2.3	Screen-printed electrode (SPE) .....	16
4.2.4	Assembling the measuring stand .....	18
4.2.5	Connecting the measuring stand and the potentiostat .....	19
4.3	Power supply .....	20
4.3.1	Charging the battery with power supply unit .....	21
4.3.2	Charging the battery via USB connector (PC) .....	21
4.4	Connecting the software with the instrument .....	22
<b>5</b>	<b>Operation</b>	<b>23</b>
5.1	Basic software operation .....	23
5.1.1	Loading and saving a file .....	23
5.1.2	Running a determination .....	25
5.1.3	Printing of result and method .....	27
5.1.4	Reevaluating a determination .....	28



<b>5.2</b>	<b>Carrying out the determination of As(total) according to Application Bulletin 416</b> .....	<b>33</b>
5.2.1	General operation .....	33
5.2.2	Initial electrode preparation .....	35
5.2.3	Running the determination of As(total) .....	36
5.2.4	Cleaning of the scTRACE Gold electrode .....	38
<b>6</b>	<b>Maintenance</b> .....	<b>40</b>
6.1	Removing the scTRACE Gold .....	40
6.2	Removing the screen-printed electrode .....	41
6.3	Removing the stirrer .....	42
6.4	Cleaning the instrument .....	43
<b>7</b>	<b>Troubleshooting</b> .....	<b>45</b>
7.1	General rules for voltammetric trace analysis .....	45
7.1.1	Sampling .....	45
7.1.2	Measuring solution .....	45
7.1.3	Quantification .....	46
7.2	Hardware problems .....	46
7.2.1	.....	46
7.3	Application problems .....	48
7.3.1	.....	48
7.4	Some voltammetric troubles in detail .....	60
7.4.1	Linear working range .....	60
7.4.2	Potential range of an scTRACE Gold electrode .....	61
7.5	Dummy cell test .....	66
<b>8</b>	<b>Technical specifications</b> .....	<b>68</b>
8.1	Potentiostat .....	68
8.2	Measuring stand .....	69
8.3	Stirrer .....	69
8.4	I/O connector .....	70
8.5	Safety specifications .....	70
8.6	Ambient temperature .....	70
8.7	Reference conditions .....	70
8.8	Connection .....	71
<b>9</b>	<b>Accessories</b> .....	<b>72</b>
	<b>Index</b> .....	<b>73</b>

## Table of figures

Figure 1	946 Portable VA Analyzer - potentiostat front view .....	5
Figure 2	946 Portable VA Analyzer - potentiostat rear view .....	5
Figure 3	946 Portable VA Analyzer - scTRACE Gold measuring stand over- view .....	6
Figure 4	946 Portable VA Analyzer - SPE measuring stand overview .....	7
Figure 5	Details SPE holder .....	8
Figure 6	Portable VA Analyzer software - overview (default workplace lay- out) .....	9
Figure 7	Assembly of stirrer .....	15
Figure 8	Assembly of scTRACE Gold electrode .....	15
Figure 9	Assembly of screen-printed electrode .....	16
Figure 10	Assembly of measuring stand .....	18
Figure 11	946 Portable VA Analyzer - potentiostat connected to measuring stand .....	19
Figure 12	Operation of measuring stand .....	34
Figure 13	Remove scTRACE Gold electrode .....	40
Figure 14	Remove screen-printed electrode .....	41
Figure 15	Remove stirrer .....	43
Figure 16	Good and bad standard addition curves .....	61
Figure 17	Influence of chloride concentration on the background current of the scTRACE Gold electrode. (Measuring solution $c(\text{H}_2\text{SO}_4) = 1 \text{ mmol/L}$ with 5, 50 and 500 mmol/L KCl) .....	62
Figure 18	Influence of oxygen on the background current of the scTRACE Gold electrode. (Measuring solution: $c(\text{H}_2\text{SO}_4) = 1 \text{ mmol/L}$ , $c(\text{KCl}) = 50$ mmol/L) .....	64
Figure 19	Influence of pH on the background current of the scTRACE Gold elec- trode. ....	65
Figure 20	946 Portable VA Analyzer - potentiostat connected to the dummy cell .....	66





# 1 Introduction

This manual gives a comprehensive description of the installation and operation of the 946 Portable VA Analyzer.



## NOTICE

Detailed application descriptions in form of **Application Notes** and **Application Bulletins** can be requested from the local Metrohm representative or downloaded from <https://www.metrohm.com>.

## 1.1 Instrument description

The 946 Portable VA Analyzer is designed for mobile use. The hardware consists of the potentiostat and the measuring stand connected via a single cable. The measuring stand is the wet chemical part. It includes the electrochemical sensor, which combines working, reference and auxiliary electrode, and a stirrer for stirring the measuring solution. The potentiostat is the electronic hardware to run the voltammetric measurement and the stirrer. The instrument is controlled by the Portable VA Analyzer software. The communication between software and hardware takes place via USB cable.

## 1.2 Intended use

The 946 Portable VA Analyzer is designed for the voltammetric determination of samples in the area of trace analysis. A potential application area is:

- Determination of heavy metals, e.g. arsenic, mercury, copper or lead, by stripping voltammetry using scTRACE Gold electrode.

The instrument is suitable for processing various chemicals. Therefore, the use of the 946 Portable VA Analyzer requires the user to have basic knowledge and experience in handling toxic and caustic substances.



## CAUTION

Neither the measuring stand nor the electrodes are resistant against organic solvents. Therefore, no organic solvents or other flammable substances should be used with the instrument.



## 1.3 Safety instructions

### 1.3.1 General notes on safety



#### WARNING

---

Operate this instrument only according to the information contained in this documentation.

This instrument left the factory in a flawless state in terms of technical safety. To maintain this state and ensure non-hazardous operation of the instrument, the following instructions must be observed carefully.

### 1.3.2 Electrical safety

The electrical safety when working with the instrument is ensured as part of the international standard IEC 61010.



#### WARNING

---

Only personnel qualified by Metrohm are authorized to carry out service work on electronic components.

#### Supply voltage



#### WARNING

---

An incorrect supply voltage can damage the instrument.

Only operate this instrument with a supply voltage specified for it (see bottom of the instrument).

#### Protection against electrostatic charges



#### WARNING

---

Electronic components are sensitive to electrostatic charges and can be destroyed by discharges.

Do not fail to pull the power cord out of the power socket before you set up or disconnect electrical plug connections at the rear of the instrument.

### 1.3.3 Recycling and disposal

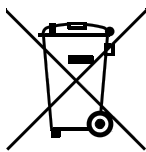





This product is covered by European Directive 2012/19/EU, WEEE – Waste Electrical and Electronic Equipment.

The correct disposal of your old instrument will help to prevent negative effects on the environment and public health.

More details about the disposal of your old instrument can be obtained from your local authorities, from waste disposal companies or from your local dealer.

## 1.4 Symbols and conventions

The following symbols and styles are used in this documentation:

(5-12)	<b>Cross-reference to figure legend</b> The first number refers to the figure number, the second to the instrument part in the figure.
1	<b>Instruction step</b> Carry out these steps in the sequence shown.
<b>Method</b>	<b>Dialog text, parameter</b> in the software
<b>File ► New</b>	Menu or menu item
<b>[Next]</b>	<b>Button or key</b>
	<b>Warning</b> This symbol draws attention to a possible life hazard or risk of injury.
	<b>Warning</b> This symbol draws attention to a possible hazard due to electrical current.
	<b>Warning</b> This symbol draws attention to a possible hazard due to heat or hot instrument parts.
	<b>Warning</b> This symbol draws attention to a possible biological hazard.
	<b>Caution</b> This symbol draws attention to a possible damage of instruments or instrument parts.



**Note**

This symbol marks additional information and tips.

## 2 Overview of the instrument

The following figures show details of the potentiostat and the measuring stand of the 946 Portable Analyzer.

### 2.1 Potentiostat

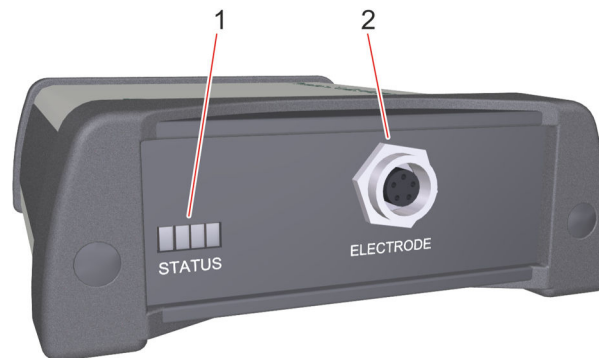





Figure 1 946 Portable VA Analyzer - potentiostat front view

#### 1 Status LEDs

-  Power on
-  Measurement running
-  Battery level low

#### 2 Electrode cable connector

Connection socket for the cable connection between potentiostat and measuring stand

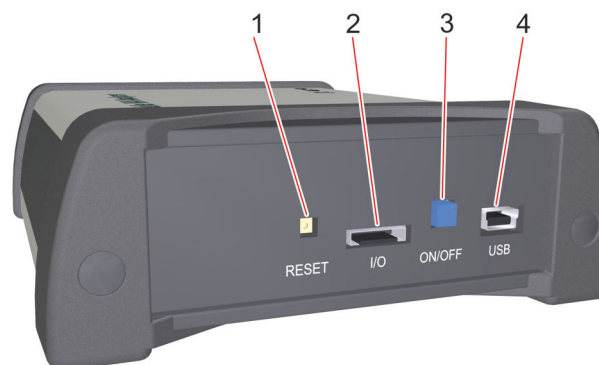

Figure 2 946 Portable VA Analyzer - potentiostat rear view

#### 1 Reset button

#### 2 I/O cable connector

Connection socket for the optional I/O controller cable (6.02135.010)

#### 3 ON/OFF button

#### 4 Type B mini USB connector

Connection socket for power supply and data transmission



## 2.2 Measuring stand scTRACE Gold

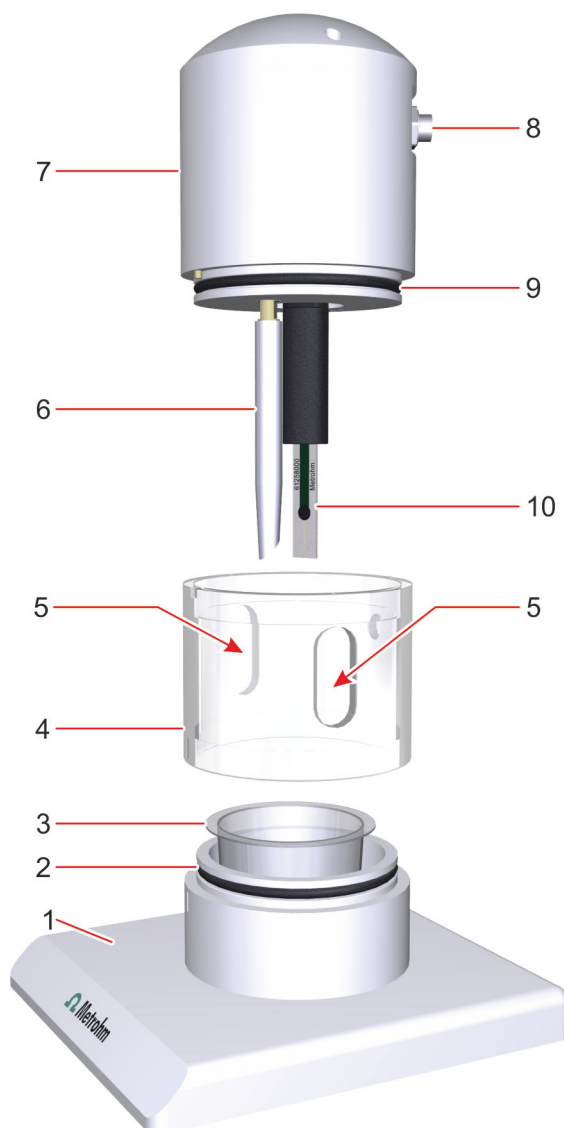

Figure 3 946 Portable VA Analyzer - scTRACE Gold measuring stand overview

<b>1</b>	<b>Base plate (6.02708.020)</b>	<b>2</b>	<b>O-ring (6.01408.000)</b>
<b>3</b>	<b>Measuring vessel (6.01412.000)</b>	<b>4</b>	<b>Transparent ring (6.02708.030)</b>
<b>5</b>	<b>Pipetting opening</b>	<b>6</b>	<b>Stirrer (6.01204.000)</b>
<b>7</b>	<b>Measuring head scTRACE Gold (6.01256.010)</b>	<b>8</b>	<b>Electrode cable connector</b> Connection socket for the cable connection between measuring stand and potentiostat
<b>9</b>	<b>O-ring (6.01408.000)</b>	<b>10</b>	<b>scTRACE Gold (6.1258.000)</b>

## 2.3 Measuring stand SPE

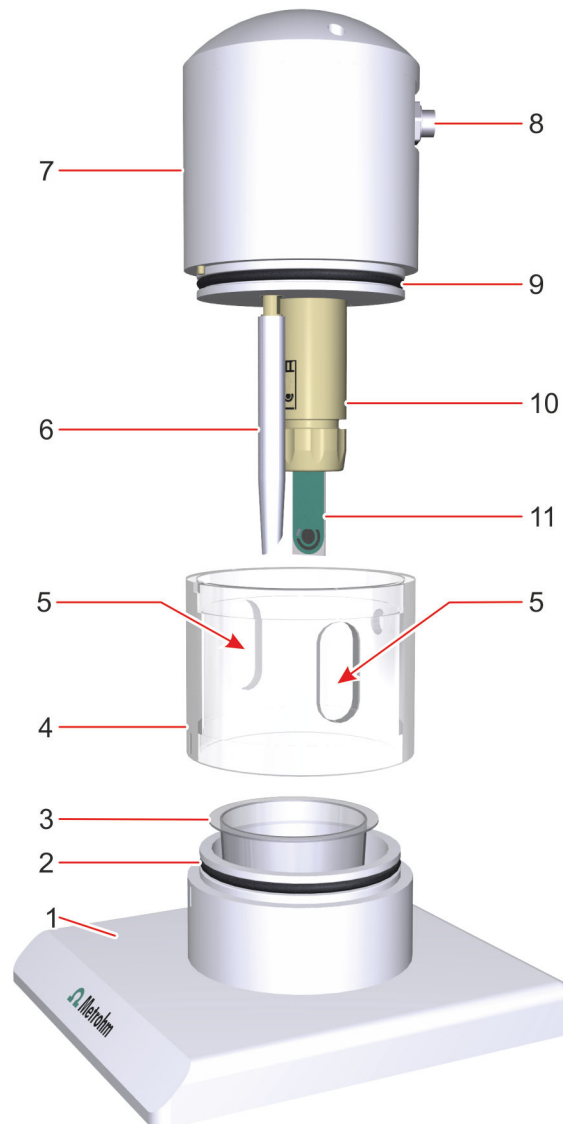

Figure 4 946 Portable VA Analyzer - SPE measuring stand overview

<b>1</b>	<b>Base plate (6.02708.020)</b>	<b>2</b>	<b>O-ring (6.01408.000)</b>
<b>3</b>	<b>Measuring vessel (6.01412.000)</b>	<b>4</b>	<b>Transparent ring (6.02708.030)</b>
<b>5</b>	<b>Pipetting opening</b>	<b>6</b>	<b>Stirrer (6.01204.000)</b>
<b>7</b>	<b>Measuring head SPE (6.01256.020)</b>	<b>8</b>	<b>Electrode cable connector</b> Connection socket for the cable connection between measuring stand and potentiostat
<b>9</b>	<b>O-ring (6.01408.000)</b>	<b>10</b>	<b>SPE holder</b>
<b>11</b>	<b>SPE (screen-printed electrode)</b>		

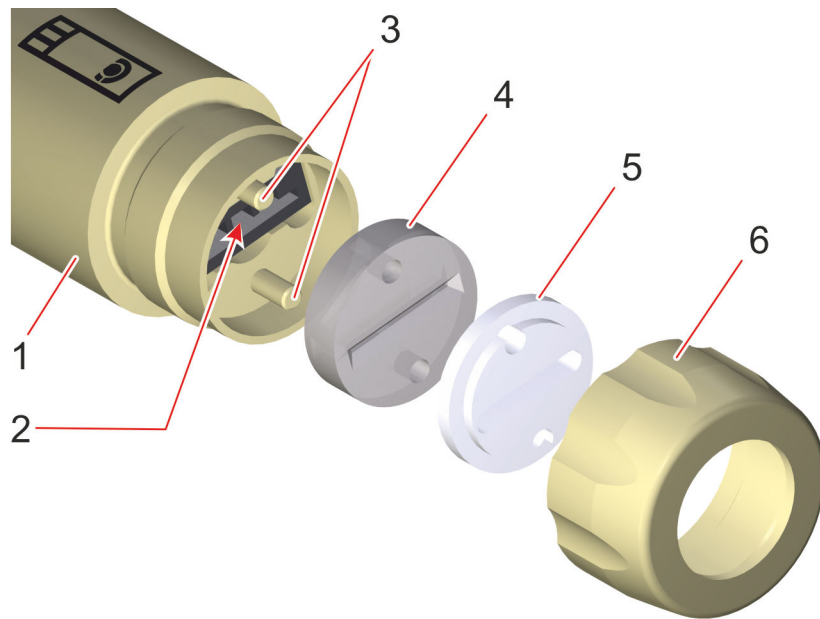

Figure 5 Details SPE holder

<p><b>1 Shaft SPE holder</b></p>	<p><b>2 Electrical connector for SPE</b> Connection socket for the screen-printed electrode</p>
<p><b>3 Positioning support</b></p>	<p><b>4 Silicone seal for SPE electrode shaft (6.1244.060)</b></p>
<p><b>5 Supporting ring for SPE electrode shaft (6.1241.210)</b></p>	<p><b>6 Nut for SPE electrode shaft (6.1241.200)</b></p>



### 3 Overview of the software

The following gives an overview of the software windows and menu functions.



#### NOTICE

More details about the software and method parameters can be found in the Portable VA Analyzer software manual (8.0105.8002EN).

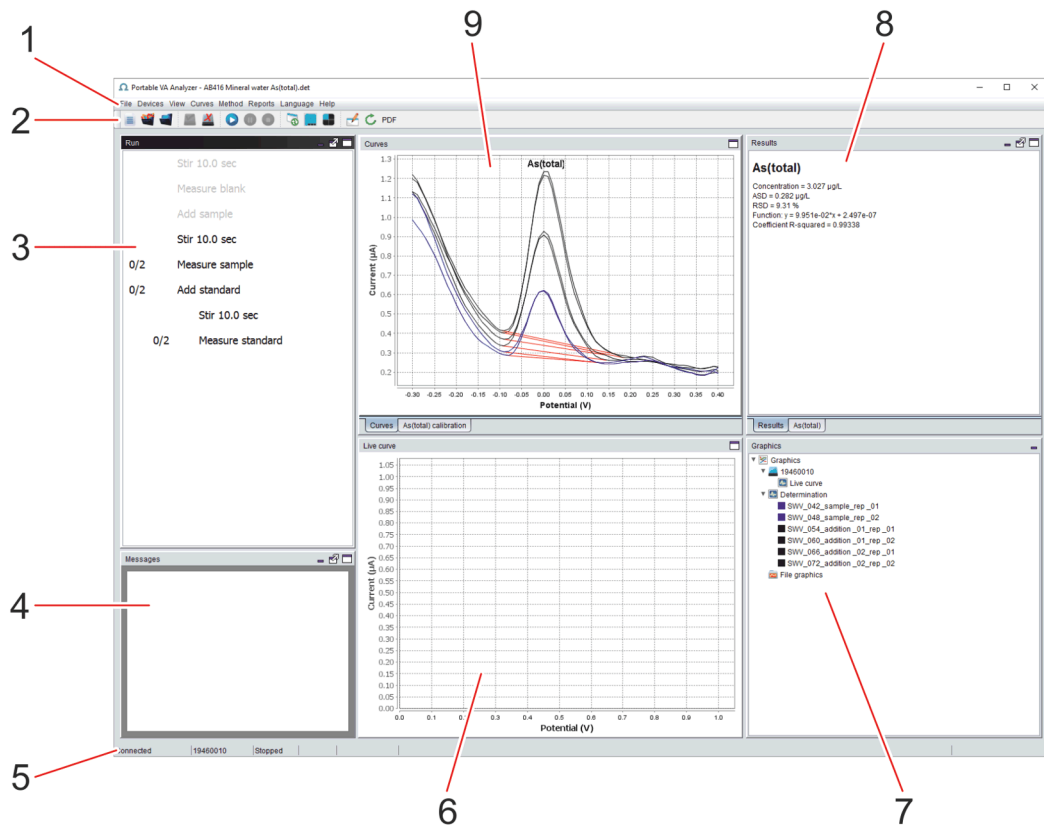

Figure 6 Portable VA Analyzer software - overview (default workplace layout)

**1** Menu bar

**3** Run subwindow

**5** Status bar

**7** Graphics subwindow

**9** Curves subwindow

**2** Toolbar

**4** Messages subwindow

**6** Live curve



**8** Results subwindow











Menu bar (6-1)

<b>File</b>	<p>Load and save a method.</p> <p>Load and save a determination.</p> <p>Reprocess the curve evaluation.</p>
<b>Devices</b>	<p>Connect / disconnect the potentiostat.</p> <p>Start / Hold / Stop the determination.</p>
<b>View</b>	<p>Selections regarding the general appearance of the curves subwindows, such as scaling, labels, and background color.</p> <p>Selection of the workplace layout.</p>
<b>Curves</b>	<p>Selections regarding appearance of curves, such as name, visibility, and color.</p> <p>Export functions for determination curves.</p>
<b>Method</b>	<p>Open the dialog window to edit method or determination parameters.</p>
<b>Reports</b>	<p>Create PDF report</p>
<b>Language</b>	<p>Select the software language English or Chinese</p>
<b>Help</b>	<p>Information regarding the device.</p> <p>Information regarding the software version.</p> <p>Link to the PDF file of the manual.</p>

Toolbar (6-2)

 <b>New method</b>	<p>Load and open a method with default square-wave parameters.</p>
 <b>Load determination</b>	<p>Opens the dialog window to load an existing determination file.</p> <p>By default determinations are saved in the folder <b><i>%USERPROFILE%\Documents\Metrohm\Portable VA Analyzer\Determination</i></b>.</p> <p>Example determinations can be found in the folder <b><i>%USERPROFILE%\Documents\Metrohm\Portable VA Analyzer\Examples\Determinations</i></b>.</p>
 <b>Load method</b>	<p>Opens the dialog window to load an existing method file.</p> <p>By default methods are saved in the folder <b><i>%USERPROFILE%\Documents\Metrohm\Portable VA Analyzer\Method</i></b>.</p> <p>Example methods can be found in the folder <b><i>%USERPROFILE%\Documents\Metrohm\Portable VA Analyzer\Examples\Methods</i></b>.</p>

 <b>Connect</b>	<p>Establish a connection between the software and the instrument via USB (see chapter 4.4, page 22).</p> <p>Inactive when an instrument is connected.</p>
 <b>Disconnect</b>	<p>Disconnect the software from the instrument.</p> <p>Inactive when no instrument is connected.</p>
 <b>Start</b>	<p>Start the determination.</p> <p>Inactive when no instrument is connected.</p>
 <b>Hold</b>	<p>Hold the determination. Click the button again to continue.</p> <p>Inactive when no instrument is connected.</p>
 <b>Stop</b>	<p>Stop the determination.</p> <p>Inactive when no instrument is connected.</p>
 <b>Default workplace</b>	<p>Change the view of the workplace to default.</p> <p>This layout shows <b>Live curve</b> and <b>Curves</b> in separate subwindows.</p> <ul style="list-style-type: none"> <li>▪ The <b>Live curve</b> subwindow is only displayed when an instrument is connected.</li> <li>▪ The <b>Curves</b> subwindow can have up to 5 tabs. <ul style="list-style-type: none"> <li>– The tab <b>Curves</b> shows an overlay of voltammograms belonging to the determination.</li> <li>– The tab(s) '<b>Substance name</b>' <b>calibration</b> show the calibration curve for a substance. Each calibration curve will be displayed on an individual tab.</li> </ul> </li> </ul>
 <b>Tabs workplace</b>	<p>Change the view of the workplace to tabs.</p> <p>This layout has only one subwindow <b>Curves</b> with a maximum of 6 tabs.</p> <ul style="list-style-type: none"> <li>▪ The tab <b>Live curve</b> is only displayed when an instrument is connected.</li> <li>▪ The tab <b>Curves</b> shows an overlay of voltammograms belonging to the determination.</li> <li>▪ The tab(s) '<b>Substance name</b>' <b>calibration</b> show the calibration curve for a substance. Each calibration curve will be displayed on an individual tab.</li> </ul>
 <b>Mosaic workplace</b>	<p>Change the view of the workplace to a mosaic.</p> <p>This layout shows all curves in individual subwindows. The actual layout depends on the number of calibration curves displayed.</p> <ul style="list-style-type: none"> <li>▪ The <b>Live curve</b> subwindow is only displayed when an instrument is connected.</li> <li>▪ The <b>Curves</b> subwindow shows an overlay of voltammograms belonging to the determination.</li> </ul>



5. Display of time, potential and current related to the voltammetric measurement.

*Live curve*

(6-6)

Live display of the currently measured voltammogram.

Subwindow in the **Default workplace** and **Mosaic workplace** layout. In the **Tabs workplace** layout it is found in the **Curves** subwindow as separate tab.

*Graphics subwindow*

(6-7)

Display of color and name of the curves belonging to the currently running or loaded determination. In this subwindow, the curves have to be selected for which name, color or visibility should be changed. Also for individual export the curves have to be selected in this subwindow.

*Results subwindow*

(6-8)

This subwindow includes 2 to 5 tabs. The tab **Results** shows the overview of the results calculated for all substances specified in the method. Evaluation details, like peak potentials and peak heights can be found on up to 4 additional tabs. One tab for each substance, tagged with '**Substance name**'.

*Curves subwindow*

(6-9)

This subwindow includes maximum 6 tabs. The tab **Curves** shows all voltammograms belonging to the determination. Calibration curves for each substance can be found on up to 4 additional tabs. One tab for each substance, tagged with '**Substance name** calibration'. In the **Tabs workplace** layout one additional tab **Live curve** is displayed in this subwindow.



## 4 Installation

### 4.1 Unpacking and inspecting the instrument

#### 4.1.1 Packaging

The instrument is supplied in a protective carrying case together with the accessories. Keep this packaging, as only this ensures safe transportation of the instrument.

#### 4.1.2 Checks

Immediately after receipt, check whether the shipment has arrived complete and without damage by comparing it with the delivery note.

#### 4.1.3 Operation site

The 946 Portable VA Analyzer has been designed for mobile application.



#### CAUTION

---

##### **Influence of weather conditions**

The instrument can be damaged as a result of direct sunlight, direct exposure to water or operation at temperatures below the freezing point.

## 4.2 Hardware installation

### 4.2.1 Stirrer

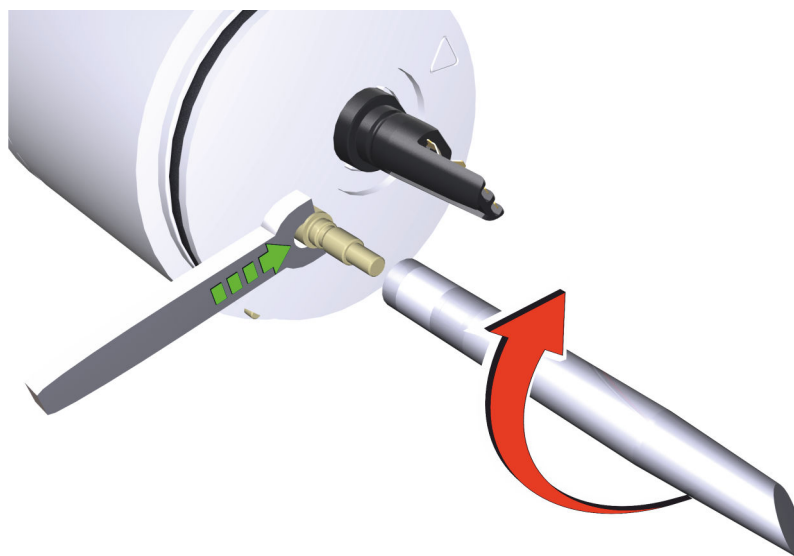

Figure 7 Assembly of stirrer

This procedure equally applies for the scTRACE Gold measuring head (6.01256.010) and the SPE measuring head (6.01256.020).

- 1 Screw the stirrer tip (6.01204.000) onto the stirrer connector. Use the 4 mm metal wrench (6.02621.000) to keep the stirrer connector from turning. Rotate the stirrer tip clockwise until the stop.

### 4.2.2 scTRACE Gold electrode

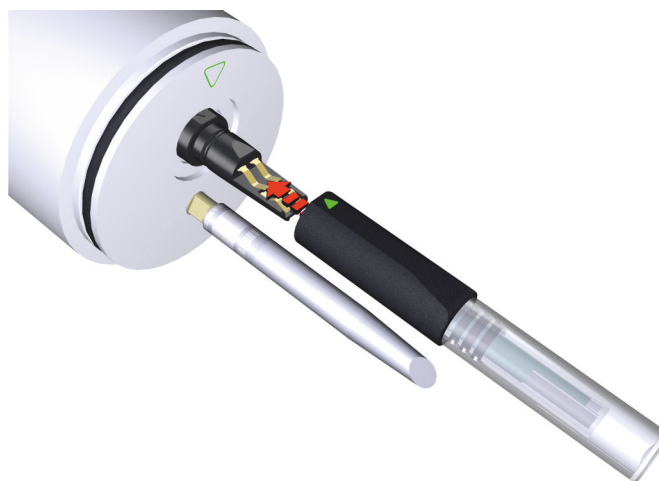

Figure 8 Assembly of scTRACE Gold electrode



- 1 Align the arrow mark on the scTRACE Gold with the arrow mark on the measuring head. Slip the scTRACE Gold onto the electrode holder until the stop.

**CAUTION**

To avoid damage to the contact springs take care not to twist the scTRACE Gold while mounting it to the electrode holder. The electrode base has to slide between the upper and lower springs.

**CAUTION**

When mounting the scTRACE Gold to the electrode holder leave the protective cap on the electrode. This is in order to avoid damage to the gold micro-wire.

### 4.2.3 Screen-printed electrode (SPE)

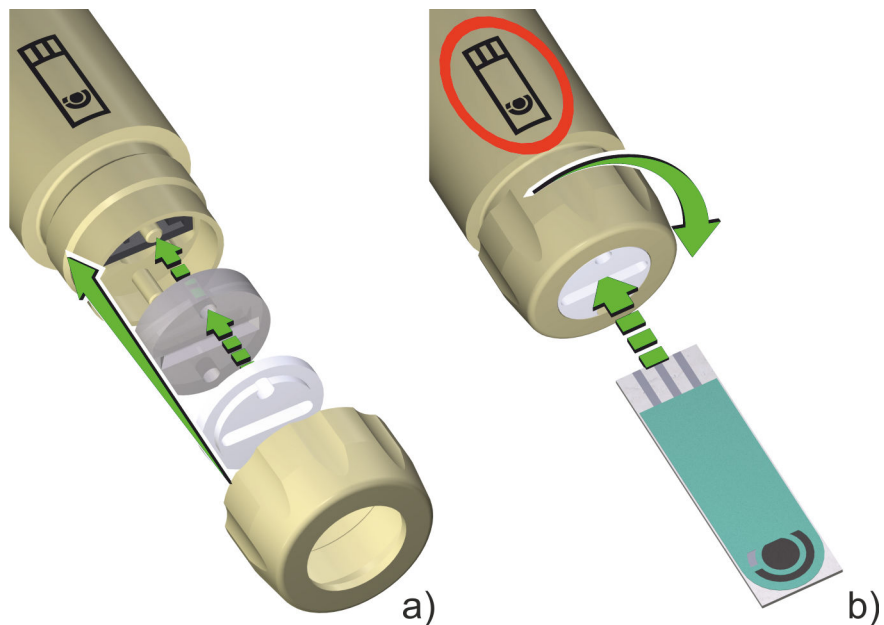

Figure 9 Assembly of screen-printed electrode



### a) Assembling the electrode holder



#### CAUTION

Before assembling the electrode holder make sure that all parts are completely dry. Check especially

- the connection socket for the SPE (5-2)
- the slot in the silicone seal (5-4)

for solution. Liquid entering the connection socket for the SPE (5-2) can damage the electrode holder.

- 1 Place the silicone seal (5-4) in the shaft of the SPE holder (5-1). The two pins (5-3) support the positioning of the seal in the shaft and prevent it from turning out of position.
- 2 Place the supporting ring (5-5) on top of the seal with the planar side pointing towards the seal. The two pins (5-3) support the positioning. The slot in the supporting ring has to be congruent with the slot in the silicone seal.
- 3 Place the nut (5-6) on the shaft. Do not tighten the nut, otherwise the SPE cannot be assembled with the holder.

### b) Assembling the SPE



#### CAUTION

Always hold screen-printed electrodes at the edges, in order not to touch the active electrode surface.

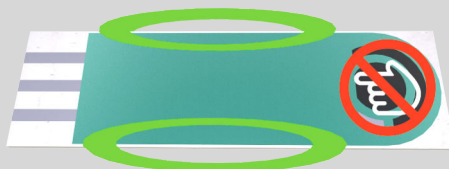

- 1 Align the screen-printed electrode with the symbol on the shaft of the electrode holder. The symbol and the electrode surface have to point in the same direction.



- 2 Slide the SPE straight into the slot of the silicone seal until the stop.

**NOTICE**

Tilting the electrode may damage the connection socket for the SPE behind the silicone seal.

- 3 Tighten the nut in a clockwise direction to fix the electrode and seal the inside of the holder against liquids.

#### 4.2.4 Assembling the measuring stand

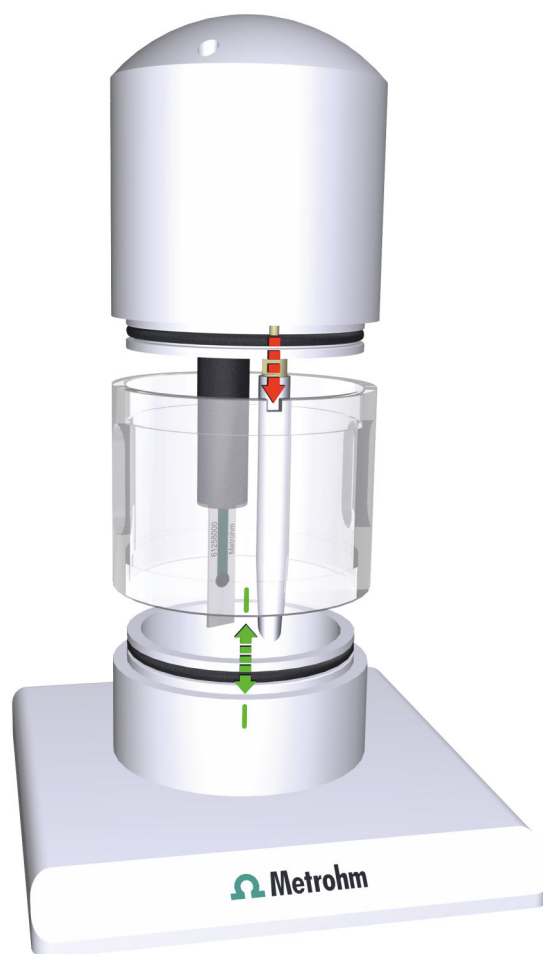

Figure 10 Assembly of measuring stand

This procedure equally applies for the scTRACE Gold measuring stand (6.5340.010) and the SPE measuring stand (6.5340.020).

- 1** Align the line on the transparent ring with the line on the base plate and push it down until the stop.
- 2** Align the positioning pin of the measuring head with the notch in the transparent ring and also press the measuring head down until the stop.

#### 4.2.5 Connecting the measuring stand and the potentiostat

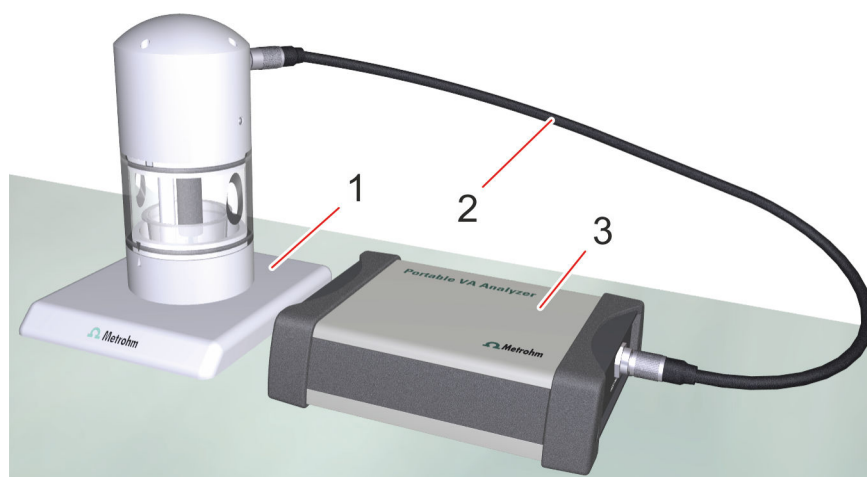

Figure 11 946 Portable VA Analyzer - potentiostat connected to measuring stand

**1** Measuring stand

**2** Electrode cable (6.02135.000)

**3** Potentiostat

Measuring stand and potentiostat are connected via the electrode cable (6.02135.000). This procedure equally applies for the scTRACE Gold measuring stand (6.5340.010) and the SPE measuring stand (6.5340.020).

- 1** Plug in the male connector of the electrode cable into the connection socket (1-2) on the front of the potentiostat.

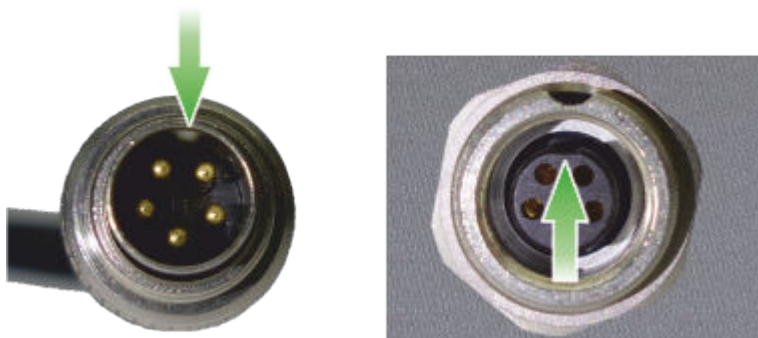

Take care of the correct orientation of the plug and tighten the screw to secure the connection.

- 2 Plug in the female connector of the electrode cable into the connection socket (3-8), (4-8) of the measuring head.

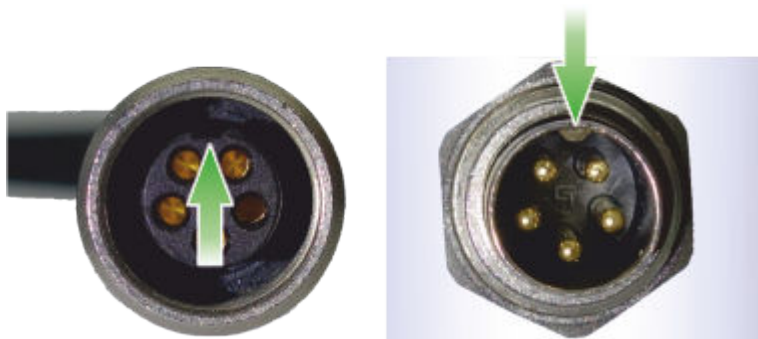

Take care of the correct orientation of the plug and tighten the screw to secure the connection.

### 4.3 Power supply

The potentiostat is equipped with a rechargeable battery. This allows mobile use independent from an external power grid.



#### NOTICE

To fully charge the battery it is recommended to connect the potentiostat to the power grid via the power supply unit.

**NOTICE**

The battery performance will deteriorate over time. If the operating times with a fully charged battery are much shorter than usual, take the instrument to a Metrohm Service to have the battery replaced.

**CAUTION**

For charging only use the supplied USB power supply unit (6.02117.000), which has been approved as accessory for use with this instrument.

**CAUTION**

The battery can only be replaced by an authorized Metrohm Service. Any attempt of unauthorized replacement will result in a loss of warranty.

**4.3.1 Charging the battery with power supply unit**

The USB power supply unit is delivered with different electrical plug adaptors (available plug types EU / UK / US / AU). Attach the suitable adapter.

- 1** Connect the USB type A plug of the USB cable (6.02108.000) to the USB connection socket of the power supply unit (6.02117.000).
- 2** Connect the USB type B mini plug of the USB cable (6.02108.000) to the USB connection socket (2-4) on the rear side of the potentiostat.
- 3** Connect the power supply unit to the power socket.

**4.3.2 Charging the battery via USB connector (PC)**

- 1** Connect the USB type A plug of the USB cable (6.02108.000) to the USB connection socket of the PC.
- 2** Connect the USB type B mini plug of the USB cable (6.02108.000) to the USB connection socket (2-4) on the rear side of the potentiostat.

**NOTICE**

Use a suitable USB connection on the computer or a USB hub with external power supply. The charging current of this setup may not be sufficient to fully charge the battery.

**NOTICE**

When the instrument is connected to the USB connector of the PC, the battery is continuously charged. However, if the measurement requires more current than supplied by the USB connector, the battery will slowly be discharged. Therefore, it is recommended to fully charge the battery via the power supply unit from time to time.

## 4.4 Connecting the software with the instrument

- 1 Connect the USB type B mini connector of the cable (6.02108.000) to the connection socket (2-4) on the rear side of the potentiostat; then connect the USB type A connector of the USB cable to the PC or laptop.

- 2 Start the Portable VA Analyzer software by double-clicking the desk-



top icon  or selecting the link **Portable VA Analyzer** under **Windows start menu** ▶ **All programs** ▶ **Metrohm** ▶ **Portable VA Analyzer**

- 3 Press the ON/OFF button (2-3) on the rear side of the potentiostat to switch on the instrument.

The green status LED (1-1) on the front of the potentiostat will indicate when the power is on.

- 4 In the Portable VA Analyzer software click on  or **Menu bar** ▶ **Devices** ▶ **Connect**.

When the instrument is correctly connected and ready to use the status bar will show **Connected** and the instrument type 19460010. Furthermore, the additional subwindow **Live curve** will appear.

## 5 Operation



### 5.1 Basic software operation

In this section, short instructions are given how to:

- *Loading a method (page 23)*
- *Saving a method (page 24)*
- *Loading a determination (page 24)*
- *Saving a determination (page 25)*

#### 5.1.1 Loading and saving a file

##### Loading a method

- 1 Click on  or on **Menu bar ▶ File ▶ Load method....**
- 2 Select the desired method file **\*.detp** in the **Load file** dialog window. If necessary, browse for the location of the method. Click on **[Open]** to load the method.  
  
The default directory for methods is *%USERPROFILE%\Documents\Metrohm\Portable VA Analyzer\Method .*  
  
Example methods can be found in the folder *%USERPROFILE%\Documents\Metrohm\Portable VA Analyzer\Examples\Methods.*
- 3 To check or edit method parameters of the loaded method click on  or **Menu bar ▶ Method ▶ Edit method parameters....**



##### NOTICE

Some method parameters, e.g. voltammetric parameters, cannot be edited anymore once a determination was carried out with the loaded method. If voltammetric parameters have to be adapted, the method file has to be reloaded.





**NOTICE**

Some method parameters, e.g. voltammetric parameters, cannot be edited in a determination file. Nonetheless the reevaluation of peaks and recalculation of standard additions is still possible. *For more information on the reevaluation of a determination see Chapter 5.1.4, page 28.*

If the voltammetric parameters of the determination method should be adapted for future measurements, the parameters have to be saved first, using the function **Save method as...** The new method, containing all parameters of the determination method, can then be loaded and edited.

**Saving a determination**

- 1 If a modified determination should be saved under the same name, click on **Menu bar ► File ► Save determination**. The existing determination file will be overwritten.

**NOTICE**

Automatically saved determinations and example determinations are read-only. In these cases use the function **Save determination as...** and save the determination under a new name.

- 2 If a modified determination should be saved under a new name, click on **Menu bar ► File ► Save determination as...**
- 3 In the **Save determination** dialog window, select the folder where the determination should be saved, type in a file name and click on **[Save]**.

**5.1.2 Running a determination**

- 1 Establish the connection between the instrument and the software.
- 2 Load the method.
- 3 Prepare the measuring solution and place it in the measuring stand. Assemble the measuring stand so that electrode and stirrer are immersed in the measuring solution.



- 4 Click on  or **Menu bar ▶ Devices ▶ Start**.
- 5 Adapt the information in the dialog window **Determination information** if necessary. When all details are correct click on **[OK]**.
- 6 When the addition of standard solution is required a message will be displayed in the subwindow **Messages**. Add the specified volume of standard solution(s) through one of the two pipetting openings in the transparent ring (3-5) and confirm the addition by clicking into the subwindow **Messages**.
  - The subwindow **Run** will show the progress of the determination.
  - The subwindow **Live curve** will display the currently measured voltammogram.
  - The subwindow **Curves** will display an overlay of already measured voltammograms on the tab **Curves**. On the tab '**Substance name**' **calibration** the corresponding calibration curve can be found.
  - The subwindow **Results** will display the results of all substances specified in the method on the tab **Results**. Evaluation details, like peak heights and peak positions, can be found in the same subwindow on the tab(s) '**Substance name**'.

At the end the determination file and, if defined in the method, also a PDF file with the report will automatically be saved.



#### NOTICE

Directories for automatic saving of determinations and reports are predefined and cannot be modified.

Determination files are saved in the directory **%USERPROFILE%\Documents\Metrohm\Portable VA Analyzer\Determination**. The file name is automatically generated from date and time of the determination start and the sample identifier and has the format **YYYYMMDD-hhmmss 'Sample identifier'.det**.

The PDF file with the report is saved in the directory **%USERPROFILE%\Documents\Metrohm\Portable VA Analyzer\Report** with the file name **YYYYMMDD-hhmmss 'Sample identifier'.det\_Report.pdf**.

**NOTICE**

Automatically saved determinations are read-only. If changes of a reevaluated determination should be saved, it has to be under a new name.

### 5.1.3 Printing of result and method

#### Printing a determination result

- 1 Load the determination file for which the report should be printed, if not already loaded in the software.
- 2 Click on  or **Menu bar ▶ Reports ▶ Create PDF ....**
- 3 In the dialog window **Create PDF report**, select the **Report elements** which should be documented in the report. The following report elements can be freely combined by selection via check box.
  - Results
    - General and determination information.
    - Table with concentration result for all substances in the determination.
  - Evaluation
    - Table with evaluation details, like peak potential and peak height, for each substance and curve.
    - Table with regression data for each substance.
  - Curves
    - Overlay of all voltammograms which are visible.
    - Individual calibration curve for each substance.
  - Method
    - Method parameters
  - Procedure
    - Method sequence

Confirm your selection by clicking on **[OK]**.

- 4 In the dialog window **Save PDF file as**, type in the file name under which the report should be saved. If necessary, browse for a different directory to save the report. Confirm the entries by clicking on **[Save]**.



The PDF file with the selected report elements will be created and saved in the specified directory.

### Printing a method

- 1 Load the method file for which the parameters should be printed, if not already loaded in the software.
- 2 Click on  or **Menu bar ▶ Reports ▶ Create PDF ...**
- 3 In the dialog window **Create PDF report** the following **Report elements** can be selected via check box.
  - Method
    - Method parameters
  - Procedure
    - Method sequence

Confirm your selection by clicking on **[OK]**.

- 4 In the dialog window **Save PDF file as** type in the file name under which the method report should be saved. If necessary, browse for a different directory to save the report. Confirm the entries by clicking on **[Save]**.

The PDF file with the method parameters will be created and saved in the specified directory.

#### 5.1.4 Reevaluating a determination

In this section short instructions can be found how to:

- *Adapting the peak recognition (page 29)*
- *Changing the final result unit (page 29)*
- *Excluding a curve from the evaluation (page 30)*
- *Adapting the baseline parameters for all curves (page 30)*
- *Adapting the base points for an individual curve (page 31)*
- *Adapting the settings for the standard addition (page 31)*
- *Adapting the sample size (page 32)*



#### NOTICE

Changes will not automatically be saved to the determination. To save changes use the function **Save determination** or **Save determination as...** (page 25).



## NOTICE

Some method parameters, e.g. voltammetric parameters, cannot be edited in a determination file.

If the voltammetric parameters of the determination method should be adapted for future measurements, the parameters have to be saved first, using the function **Save method as...** (page 24). The new method, containing all parameters of the determination method, can then be loaded and edited.

### Adapting the peak recognition

- 1 Click on  or **Menu bar ▶ Method ▶ Edit method parameters....**
- 2 In the dialog window **Method parameters**, go to the tab **Evaluation**. In the section **Substances**, change the settings for the peak recognition, e.g. **Characteristic potential** or **Tolerance** as required.
- 3 Close the dialog window **Method parameters** with **[OK]**.  
The determination will automatically be recalculated with the new settings.

### Changing the final result unit

- 1 Click on  or **Menu bar ▶ Method ▶ Edit method parameters....**
- 2 In the dialog window **Method parameters** go to the tab **Evaluation**. In the section **Substances** go to the column **Result unit** and select a unit from the drop-down menu.



## NOTICE

The **Result unit** depends on the unit of the standard solution. If the concentration of the standard solution is a mass concentration, e.g. mg/L, also the result unit has to be a mass concentration, e.g. µg/L. If the concentration of the standard solution is a molar concentration, e.g. µmol/L, the result unit has to be a molar concentration too, e.g. nmol/L.

- 3 Close the dialog window **Method parameters** with [OK].

The determination will automatically be recalculated and displayed with the new result unit.

## Excluding a curve from the evaluation

- 1 On the workplace go to the subwindow **Results** and select the tab with the name of the substance for which a curve should be excluded from the evaluation.
- 2 In the column **Used** deactivate the check box of the curve which should be excluded from the evaluation.
- 3 Click on  or **Menu bar ▶ File ▶ Reprocess** to reprocess the evaluation and calculation without the excluded curve.

## Adapting the baseline parameters for all curves

- 1 Click on  or **Menu bar ▶ Method ▶ Edit method parameters....**
- 2 In the dialog window **Method parameters** go to the tab **Evaluation**, section **Substances**.  
To set manual base points, deactivate the check box **Base points automatically** and type in values for **Start base point** and/or **End base point**.  
A different baseline type can be selected from the drop-down menu **Baseline type**.
- 3 Close the dialog window **Method parameters** with [OK].

The determination will automatically be recalculated with the new settings.

### Adapting the base points for an individual curve

- 1 On the workplace, go to the subwindow **Results** and select the tab with the name of the substance for which the base point(s) should be adapted.
- 2 In the column **Manual base points**, activate the check box for the curve for which the base point(s) should be adapted.
- 3 Type in the new values for the base points in the column **Start base point** and/or **End base point**.
- 4 Click on  or **Menu bar ► File ► Reprocess** to reprocess the evaluation and calculation with the new settings for the base point(s).

### Adapting the settings for the standard addition



#### NOTICE

The number of additions cannot be adapted subsequently. However, curves can be excluded from the evaluation as described above (see *"Excluding a curve from the evaluation"*, page 30).

- 1 Click on  or **Menu bar ► Method ► Edit method parameters....**
- 2 In the dialog window **Method parameters**, go to the tab **Evaluation**.
- 3 To adapt the concentration of the standard solution go to the section **Standard solutions**. Adapt concentration and/or concentration unit of the substance in the standard solution as required.

**NOTICE**

A substance can only be contained in one standard solution. In case of multiple standards, the concentration in the other standard solution(s) has to be 0.

**NOTICE**

The **Unit** of the standard solution is linked to the **Result unit** of the final result of the substance. If the concentration of the standard solution is a mass concentration, e.g. mg/L, also the result unit has to be a mass concentration, e.g. µg/L. If the concentration of the standard solution is a molar concentration, e.g. µmol/L, the result unit has to be a molar concentration too, e.g. nmol/L.

- 4 To adapt the volume of the standard addition go to the section **Volumes** and adapt the addition volume of the standard solution as required.

**NOTICE**

The addition volume has to be specified in mL (milliliter).

- 5 Close the dialog window **Method parameters** with **[OK]**.  
The determination will automatically be recalculated with the new settings.

**Adapting the sample size**

- 1 Click on  or **Menu bar ▶ Method ▶ Edit method parameters....**
- 2 In the dialog window **Method parameters** go to the tab **Determination**.
- 3 In the section **Sample and volume** adapt the volume for **Sample volume** and/or **Total cell volume**.



**NOTICE**

All volumes have to be in mL (milliliter).

The **Total cell volume** is the volume of all solutions at the start of the determination. This includes sample volume and auxiliary solutions such as additional water and electrolyte, but not volumes for standard addition. The standard addition volume will automatically be taken into account.

- 4 Close the dialog window **Method parameters** with [OK].

The determination will automatically be recalculated with the new settings.

## 5.2 Carrying out the determination of As(total) according to Application Bulletin 416

**NOTICE**

More detailed information on this application can be found in the **Application Bulletin 416 - Determination of arsenic in water with the scTRACE Gold**, which is available for download from <https://www.metrohm.com>.

On this website also other applications using the scTRACE Gold electrode and the 946 Portable VA Analyzer can be found.

### 5.2.1 General operation

Prepare the reagents as described in Application Bulletin 416. The following reagents are required for the determination of As(total) with the 946 Portable VA Analyzer:

<b>Cleaning solution</b>	$c(\text{H}_2\text{SO}_4) = 0.5 \text{ mol/L}$ , $c(\text{KCl}) = 0.05 \text{ mol/L}$
<b>Electrolyte</b>	$c(\text{sulfamic acid}) = 1 \text{ mol/L}$ , $c(\text{citric acid}) = 0.5 \text{ mol/L}$ , $c(\text{KCl}) = 0.45 \text{ mol/L}$
<b>KMnO<sub>4</sub> solution</b>	$c(\text{KMnO}_4) = 0.2 \text{ mmol/L}$
<b>As(V) standard solution</b>	$\beta(\text{As}^{\text{V}}) = 0.5 \text{ mg/L}$

**NOTICE**

It is recommended to use only reagents of highest quality, e.g. Merck suprapur® or Honeywell/Fluka TraceSelect®. The water for preparation of reagents and for rinsing should have ultrapure quality (resistivity >18 MΩ·cm (25 °C), type I grade (ASTM D1193)).

Setup the hardware as described in *Chapter 4.2 Hardware installation (page 15)*. Make sure that the battery is fully charged.

Establish the connection between software and potentiostat as described in *Chapter 4.4 Connecting the software with the instrument (page 22)*.

In daily operation the measuring head module consisting of measuring head (3-7), scTRACE Gold electrode (3-10), stirrer (3-6) and transparent ring (3-4) can stay assembled. Only if the stirrer needs to be replaced, the transparent ring has to be removed.



Figure 12 Operation of measuring stand

## 5.2.2 Initial electrode preparation

A new scTRACE Gold electrode needs to be initially activated and then cleaned before it can be used for a determination.



### NOTICE

The procedure *Activation of the scTRACE Gold* should only be carried out once with a new electrode. Repeated activation will reduce the life-time of the scTRACE Gold.

### Activation of the scTRACE Gold

- 1 Load the example method **AB416 Activation scTRACE Gold.detp** (see "Loading a method", page 23).
- 2 Fill 18 mL cleaning solution into the measuring vessel (3-3). Use the scaling on the vessel to measure the volume.
- 3 Position the measuring vessel on the base plate (3-1) of the measuring stand. Fit the measuring head, with scTRACE Gold, stirrer and transparent ring assembled, in a way that electrode and stirrer immerse into the solution. Press the measuring head down until the stop.
- 4 Start the activation of the scTRACE Gold as described in *Running a determination* (page 25).



### NOTICE

This method does not contain additions. The determination is finished after 4 replications.

- 5 When the activation is finished remove the measuring head, with scTRACE Gold, stirrer and transparent ring assembled, empty the measuring vessel and thoroughly rinse electrode, stirrer and vessel with ultrapure water.



### Cleaning of the scTRACE Gold

- 1 Load the example method **AB416 Cleaning scTRACE Gold.dets** (see "Loading a method", page 23).
- 2 Fill 18 mL cleaning solution into the measuring vessel (3-3). Use the scaling on the vessel to measure the volume.
- 3 Position the measuring vessel on the base plate (3-1) of the measuring stand. Fit the measuring head, with scTRACE Gold, stirrer and transparent ring assembled, in a way that electrode and stirrer immerse into the solution. Press the measuring head down until the stop.
- 4 Start the cleaning of the scTRACE Gold as described in *Running a determination* (page 25).



#### NOTICE

This method does not contain additions. The determination is finished after 4 replications.

- 5 When the cleaning is finished remove the measuring head, with scTRACE Gold, stirrer and transparent ring assembled, empty the measuring vessel and thoroughly rinse electrode, stirrer and vessel with ultrapure water.

### 5.2.3 Running the determination of As(total)

- 1 Load the example method **AB416 Determination As(total).dets** (see "Loading a method", page 23).
- 2 Fill 15 mL sample into the measuring vessel (3-3). Use the scaling on the vessel or a pipette to measure the volume accurately.
- 3 Add 3 mL electrolyte, using a pipette, e.g. 6.01562.000 which is in the scope of delivery.
- 4 Add 100  $\mu\text{L}$   $\text{KMnO}_4$  solution using a micro pipette, e.g. 6.01562.010 which is in the scope of delivery.

**NOTICE**

The addition of  $\text{KMnO}_4$  is only required if the sample contains  $\text{As}^{\text{III}}$  as well as  $\text{As}^{\text{V}}$ . If the sample only contains  $\text{As}^{\text{V}}$ , the determination can be carried out without the addition of  $\text{KMnO}_4$  solution.

- 5** Position the measuring vessel on the base plate (3-1) of the measuring stand. Fit the measuring head, with scTRACE Gold, stirrer and transparent ring assembled, in a way that electrode and stirrer immerse into the solution. Press the measuring head down until the stop.
- 6** Start the determination as described in *Running a determination* (page 25).
- 7** When prompted, add 100  $\mu\text{L}$   $\text{As}(\text{V})$  standard solution through one of the two pipetting openings in the transparent ring (3-5) using a micro pipette, e.g. 6.01562.010, which is in the scope of delivery.
- 8** When the determination is finished, remove the measuring head, with scTRACE Gold, stirrer and transparent ring assembled, empty the measuring vessel and thoroughly rinse electrode, stirrer and vessel with ultrapure water.

**NOTICE**

The example method **AB416 Determination As(total).detp** has a linear working range (see chapter 7.4.1, page 60) from approx. 1  $\mu\text{g/L}$  to 20  $\mu\text{g/L}$  arsenic. If samples with higher concentration should be measured, the method parameter **Waiting time 1** can be reduced. A deposition time of e.g. 30 s would change the working range to approx. 2  $\mu\text{g/L}$  to 40  $\mu\text{g/L}$ . In this case volume and/or concentration of the standard solution have to be adapted, too.

**NOTICE**

When the concentration in the sample is too high, less sample can be used for the determination. The remaining volume to the original 15 mL should be replaced by ultrapure water. Take care that the total volume at the beginning of the determination is minimum 16 mL and at the end of the determination not more than 23 mL. This restriction is due to the construction of the scTRACE Gold electrode.

**NOTICE**

When not in use, the electrode should be stored dry. Before the sensor is stored, it should be thoroughly rinsed with ultrapure water. To put it back into operation, it is often sufficient to run a blank determination, replacing the sample by ultrapure water but using the parameters for a sample determination. If that is not sufficient, carry out the cleaning procedure described in *Chapter 5.2.4 Cleaning of the scTRACE Gold electrode (page 38)*.

**NOTICE**

The scTRACE Gold electrode has a limited lifetime. If the performance of the electrode cannot be recovered by the cleaning procedure described in *Chapter 5.2.4 Cleaning of the scTRACE Gold electrode (page 38)*, the electrode needs to be replaced. Indications for an outdated electrode are:

- Significantly lower sensitivity.
- Higher or very noisy background current.
- Unusual peak shape.

#### 5.2.4 Cleaning of the scTRACE Gold electrode

Mechanical cleaning of the scTRACE Gold electrode is not possible. If the background current is unusually high or peaks show an unusual shape, an electrochemical cleaning can be carried out. The cleaning procedure can be carried out before, after, but also in between a series of determinations.

**NOTICE**

Extensive cleaning and multiple repetitions of the cleaning procedure can reduce the lifetime of the scTRACE Gold.

**CAUTION**

The printed parts of the scTRACE Gold are not resistant against organic solvents. Therefore, no organic solvents, not even ethanol, should be used for cleaning purposes.

- 1** Load the example method **AB416 Cleaning scTRACE Gold.detp** (see "Loading a method", page 23).
- 2** Fill 18 mL cleaning solution into the measuring vessel (3-3). Use the scaling on the vessel to measure the volume.
- 3** Position the measuring vessel on the base plate (3-1) of the measuring stand. Fit the measuring head, with scTRACE Gold, stirrer and transparent ring assembled, in a way that electrode and stirrer immerse into the solution. Press the measuring head down until the stop.
- 4** Start the cleaning of the scTRACE Gold as described in *Running a determination*, page 25.

**NOTICE**

This method does not contain additions. The determination is finished after 4 replications.

- 5** When the cleaning is finished remove the measuring head, with scTRACE Gold, stirrer and transparent ring assembled, empty the measuring vessel and thoroughly rinse electrode, stirrer and vessel with ultrapure water.



## 6 Maintenance

### 6.1 Removing the scTRACE Gold

To prevent cross-contaminations between different applications or if the electrode performance is bad, the scTRACE Gold electrode can be replaced.



#### NOTICE

The scTRACE Gold electrode has a limited lifetime. If the performance of the electrode cannot be recovered by the cleaning procedure described in the respective application description or in *Chapter 5.2.4 Cleaning of the scTRACE Gold electrode (page 38)*, the electrode needs to be replaced. Indications for an outdated electrode are:

- Significantly lower sensitivity.
- Higher or very noisy background current.
- Unusual peak shape.

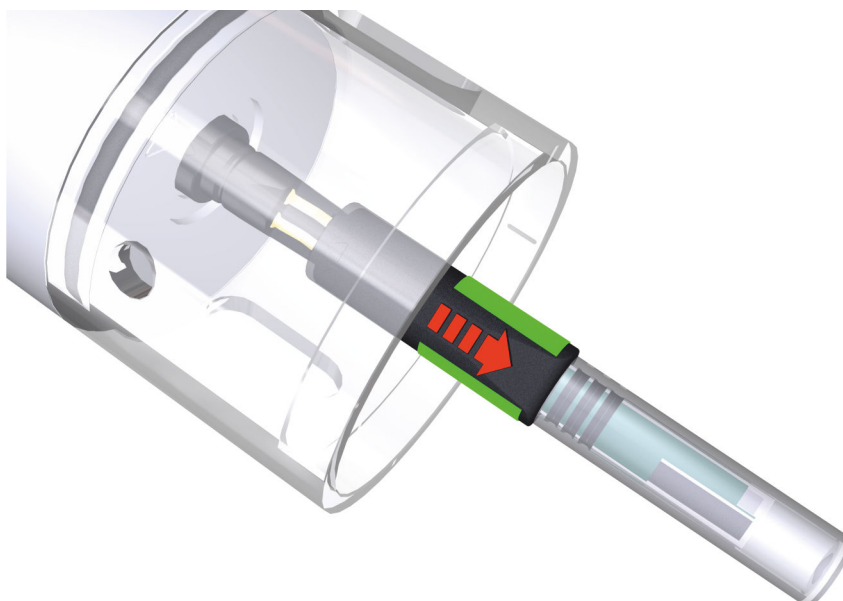

Figure 13 Remove scTRACE Gold electrode

- 1** Remove the measuring head, with transparent ring and scTRACE Gold assembled from the measuring stand.



- 2 If the scTRACE Gold should be used again later, put the protective cap back on the electrode to avoid damage to the gold micro-wire.
- 3 Hold the scTRACE Gold left and right on the splash protection as indicated with the green marks in *Figure 13*.
- 4 Pull the electrode straight off the electrode holder.



#### CAUTION

Take care not to twist the electrode while pulling it off. Tilting the electrode may damage the contact springs of the electrode holder or the electrode itself.

## 6.2 Removing the screen-printed electrode



#### NOTICE

Screen-printed electrodes can only be used for a limited number of measurements and have to be replaced in regular intervals. The lifetime and the frequency of replacement depend on the type of electrode and the application. Details can be found in the respective application documentation.

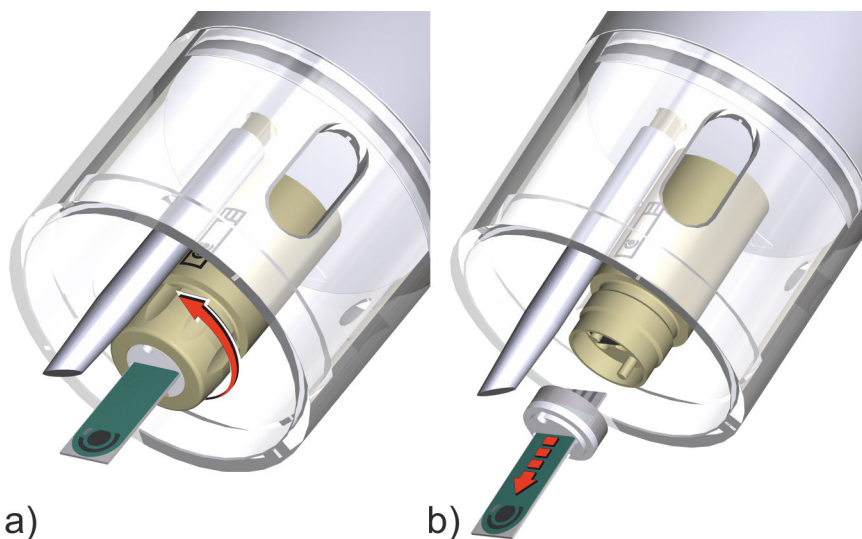

a)

b)

Figure 14 Remove screen-printed electrode



- 1 Remove the measuring head, with the transparent ring and the SPE assembled, from the measuring stand.
- 2 Unfasten the nut (5-6) in a counterclockwise direction (see Figure 14 a)) and remove it from the electrode holder.

**NOTICE**

The nut can be slippery when wet. In this case dry the electrode holder with a tissue before unfastening the nut.

- 3 Pull out the SPE together with the silicone seal (5-4) and the supporting ring (5-5) (see Figure 14 b)).
- 4 Separate the SPE from the silicone seal and the supporting ring.
  - Discard the SPE.
  - The silicone seal and the supporting ring can be reused.
- 5 Thoroughly dry all parts of the electrode holder.

**NOTICE**

Before reassembling the electrode holder as described in chapter 4.2.3, page 16 make sure that the electrical connector for the SPE (5-2), the silicone seal (5-4), and the supporting ring (5-5) are completely dry. Check especially the slot in the silicone seal for residual solution.

## 6.3 Removing the stirrer

The stirrer can be removed for cleaning purpose.

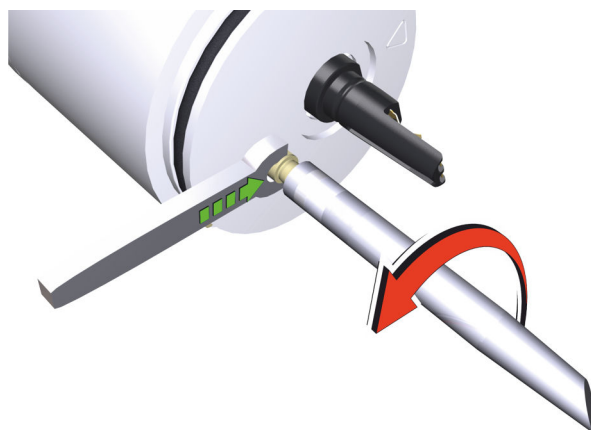

Figure 15 Remove stirrer

This procedure equally applies for the scTRACE Gold measuring head (6.01256.010) and the SPE measuring head (6.01256.020).

- 1 Remove the scTRACE Gold electrode (see chapter 6.1, page 40) or the screen-printed electrode (see chapter 6.2, page 41).
- 2 Remove the transparent ring (3-4), (4-4).
- 3 Unscrew the stirrer tip (6.01204.000) counterclockwise. Use the 4 mm metal wrench (6.02621.000) to keep the stirrer connector from turning.

## 6.4 Cleaning the instrument

### Base plate and transparent ring

- 1 Clean the base plate (3-1), (4-1) and the transparent ring (3-4), (4-4) under running water. A mild dishwashing detergent can be used, too.



#### NOTICE

No scouring pad should be used with the transparent ring to avoid scratching the surface.

**CAUTION**

The measuring stand is made of PETP (polyethylene terephthalate) and PMMA (polymethyl methacrylate). PETP is only conditionally and PMMA not resistant against organic solvents. Therefore, no organic solvents, such as methanol, ethanol or acetone, should be used for cleaning.

**Measuring head**

Clean the measuring head (3-7), (4-7) with a moist cloth. Take care that no solution seeps into the electrical contacts.

**Potentiostat**

Clean the potentiostat (*see chapter 2.1, page 5*) with a moist cloth. Take care that no solution seeps into the electrical contacts.

**scTRACE Gold electrode**

The cleaning and conditioning of the electrode is described in the respective application documentation.

**Screen-printed electrode**

Screen-printed electrodes can only be used for a few measurements, therefore usually no extensive cleaning is carried out. If it is necessary, the cleaning and conditioning of the electrode is described in the respective application documentation.

**CAUTION**

In general, screen-printed electrodes and the printed parts of the scTRACE Gold electrode are not resistant against organic solvents. Not even ethanol should be used for cleaning.

**CAUTION**

Spilled chemicals should be removed immediately. In particular the electrical connections should be protected from contamination.

## 7 Troubleshooting

### 7.1 General rules for voltammetric trace analysis

#### 7.1.1 Sampling

**The analysis is only as good as the sample.**

- Make sure that the sample is representative.
- Be aware of contamination risks.

#### 7.1.2 Measuring solution

- The analyte must be in ionic form, e.g.  $\text{AsO}_4^{3-}$ ,  $\text{Hg}^{2+}$  or  $\text{Cu}^{2+}$ .
- The measuring solution must have a sufficient conductivity. Take care that the used electrolyte is sufficiently concentrated. Check Metrohm application documentation, e.g. Application Bulletins, for detailed information on the electrolyte.
- Some components of the electrolyte, e.g. organic buffers or complexing agents, may not be stable over a longer period of time. Take care that the electrolyte is prepared freshly in appropriate intervals.
- The measuring solution must be free of interfering substances. Possible interferences are:
  - Substances producing interfering voltammetric signals, such as
    - Oxygen,  $\text{H}_2\text{O}_2$ , other metal ions
    - Organic compounds (e.g. nitro compounds)
    - Anions (e.g. nitrite, sulfite)
  - Substances complexing the analyte ions, such as
    - Organic complexing agents (e.g. EDTA, humic acids, etc.)
    - Anions or cations forming hardly soluble salts with the analyte (e.g.  $\text{As}_2\text{S}_3$  or  $\text{As}_2\text{S}_5$ ,  $\text{Hg}(\text{CN})_2$ )
  - Substances blocking the surface, such as
    - Surfactants

Organic interferences can be destroyed by e.g. UV digestion.

- Be aware of contamination risks, interfering substances as well as the analyte itself (keyword: blank)
  - Every surface, measuring vessel, electrode and other equipment in contact with sample or reagents, can be contaminated.
  - Reagents as well as the water used for the preparation of reagents can contain impurities. Make sure to use only reagents of highest quality, e.g. Merck suprapur® or Honeywell/Fluka TraceSelect®. The water for preparation of reagents and for rinsing should have ultrapure quality (resistivity  $>18 \text{ M}\Omega \cdot \text{cm}$  (25 °C), type I grade (ASTM D1193)).



### 7.1.3 Quantification

The concentration of the analyte is determined by standard addition technique. The following section lists some requirements for a successful standard addition:

- The concentration of the analyte in the standard solution must be known. Standard stock solutions with a certified concentration are commercially available for many metal ions.
- Diluted metal standard solutions (mg/L range) should be acidified to pH 1 - 2, to avoid loss of analyte due to the formation of hydroxides.
- Very diluted standard solutions ( $\mu\text{g/L}$  range) are not stable and should be prepared freshly.
- Volume and concentration of the standard addition solution should be chosen in a way that the total volume of additions does not exceed 10 % of the total volume of the measuring solution. Normal addition volumes are in the range 50 - 200  $\mu\text{L}$ .
- Volume and concentration of the standard addition solution should be chosen in a way that the peak after the last addition is 2 - 5 times higher than the sample peak.
- The sample peak and all standard addition peaks have to be within the linear working range of the method (*see chapter 7.4.1, page 60*).

## 7.2 Hardware problems

Problem	Cause	Remedy
<b>Potentiostat - the potentiostat cannot be connected to the software.</b>	<i>The USB cable is not connected.</i>	Connect the USB cable between potentiostat and PC/laptop as described in ( <i>see chapter 4.4, page 22</i> ).
	<i>The potentiostat is switched off.</i>	Switch on the potentiostat and check for the green status LED which indicates that the power is on.
	<i>The connect button is clicked too shortly after switching on the instrument.</i>	After the potentiostat is switched on it takes a few seconds before the USB communication is established. Allow 5 s and retry to connect the potentiostat.
<b>Potentiostat - the potentiostat cannot be turned on or switches off immediately.</b>	<i>Battery level too low.</i>	Connect the potentiostat to the power grid using the USB power supply unit ( <i>see chapter 4.3.1, page 21</i> ). Charge the battery for at least 1 hour before switching on the potentiostat again.



<b>Problem</b>	<b>Cause</b>	<b>Remedy</b>
	<i>Technical failure.</i>	Disconnect the USB cable from the potentiostat and try to switch it on again. If the green status LED indicates that the potentiostat is on, reconnect the USB cable.
<b>Potentiostat - the potentiostat switches off during a determination.</b>	<i>Battery level too low.</i>	Connect the potentiostat to the power grid using the USB power supply unit ( <i>see chapter 4.3.1, page 21</i> ). Charge the battery for at least 1 hour before switching on the potentiostat again.
<b>SPE - liquid is found close to the connection socket for the SPE.</b>	<i>The nut is not tightened enough.</i>	Fasten the nut until the slot in the silicone seal completely seals the SPE.
	<i>The silicone seal is defective.</i>	The silicone seal is a consumable. The sharp-edged SPEs can cut into the silicone. It is recommended to replace the silicone seal every 25 electrodes.
	<i>The supporting ring is bent.</i>	The supporting ring deforms over time. Replace the supporting ring when it is deformed and therefore does not equally distribute the pressure anymore.
<b>SPE - the SPE cannot be inserted into the holder.</b>	<i>The nut is already too tight and seals the slot in the silicone seal.</i>	Unfasten the nut to release pressure from the silicone seal which opens the slot for the SPE.
	<i>The supporting ring turned out of position.</i>	Unfasten the nut and turn the supporting ring so that the slot in the supporting ring is congruent with the slot in the silicone seal. Also make sure that the planar side of the supporting ring is attached to the silicone seal.
<b>Stirrer - the stirrer does not rotate.</b>	<i>The electrode cable is not correctly connected.</i>	Check that the plugs are connected with the correct orientation ( <i>see chapter 4.2.5, page 19</i> ).
	<i>The electrode cable is loose.</i>	Make sure that the screws of the cable connections are securely tightened.
	<i>The stirring and/or waiting time in the method is 0.</i>	The stirrer only runs during stirring and potentiostatic pretreatment. Load the method and set the correct time for <b>Stirring time</b> , <b>Waiting time 1</b> and <b>Waiting time 2</b> .



Problem	Cause	Remedy
	<i>Stirrer motor jammed.</i>	Check whether it is possible to manually rotate the stirrer. If it does not rotate freely, contact your local Metrohm Service.
<b>scTRACE Gold - the electrode disintegrates very fast.</b>	<i>Activation and/or cleaning of the electrode is carried out too often.</i>	Verify that it is necessary to clean the electrode so often. In some cases a measurement in standard solution instead of sample is sufficient to clean the electrode.
	<i>The working electrode has oxidized during the measurement.</i>	Components of the sample matrix, e.g. chloride, can facilitate the oxidation of the electrode (see "Influence of chloride", page 61). Survey the composition of your sample and adapt the voltammetric parameters if necessary.
	<i>Organic solvents are used.</i>	The printed parts of the scTRACE Gold electrode are not resistant against organic solvents. Therefore, no organic solvents, not even ethanol, should be used for cleaning or as part of the measuring solution.

## 7.3 Application problems

Problem	Cause	Remedy
<b>Calibration curve - the calibration curve is not displayed or calculated.</b>	<i>The peaks are not evaluated.</i>	See <i>Peak evaluation - peaks are not evaluated.</i>
	<i>Calibration curve is not monotonic.</i>	<p>The calibration curve has to be either monotonically decreasing or increasing. The reason that the calibration curve is not monotonic can be an outlier of an individual point or a random distribution of calibration points.</p> <p><b>Individual outlier</b></p> <ul style="list-style-type: none"> <li>Adapt the evaluation parameters to get also the outlier peak evaluated (see "Adapting the baseline parameters for all curves", page 30).</li> <li>Set the base points for the outlier manually to evaluate the peak correctly (see "Adapting the base points for an individual curve", page 31).</li> </ul>



Problem	Cause	Remedy
		<ul style="list-style-type: none"> <li>▪ Exclude the outlier from the calibration curve (see "Excluding a curve from the evaluation", page 30).</li> </ul>
		<p><b>Random calibration points</b></p> <p>In this case, check the application:</p> <ul style="list-style-type: none"> <li>▪ Does the peak for the analyte appear at the correct position with the correct shape?</li> <li>▪ Does a determination in standard solution work correctly?</li> <li>▪ Are the correct reagents used?</li> <li>▪ Is the sample in the suitable concentration range?</li> <li>▪ Is the electrode in a good condition?</li> </ul>
	<i>The number of additions in the method is 0.</i>	Check the method parameter <b>No. of additions</b> on the tab <b>Determination</b> .
<b>Calibration curve - the calibration curve is not linear or poorly reproducible.</b>	<i>The standard additions are outside the linear working range.</i>	Make sure the sample peak and all peaks for the standard addition are within the linear working range of the method (see chapter 7.4.1, page 60).
	<i>The peaks are not evaluated correctly.</i>	Check the baselines for all peaks and adapt the evaluation settings if necessary (see <i>Adapting the baseline parameters for all curves</i> (page 30), <i>Adapting the base points for an individual curve</i> (page 31) or <i>Excluding a curve from the evaluation</i> (page 30)).
	<i>Pipetting has not been carried out correctly.</i>	<ul style="list-style-type: none"> <li>▪ The standard additions have to be carried out by the same person using the same pipette.</li> <li>▪ Read up on the correct pipetting in the manual of the pipette.</li> <li>▪ Control and recalibrate the pipette.</li> </ul>
	<i>The standard solution is not added through the pipetting opening.</i>	If the electrode is removed from the measuring solution for standard addition, the condition of the electrode changes, and with it also the response to the analyte can change. Therefore, the standard solution always has to be added through one of the pipetting openings (3-5).



<b>Problem</b>	<b>Cause</b>	<b>Remedy</b>
	<i>The method parameters are not correct.</i>	Check the voltammetric parameters, in particular the parameters for cyclic voltammetric and potentiostatic pretreatment.
	<i>The electrode is not in a good condition.</i>	Clean the electrode as recommended in the application documentation and repeat the determination. If the situation does not improve, replace the electrode by a new one.
	<i>The standard solution is too old.</i>	Prepare a fresh standard solution. Also consider the age of the standard stock solution.
	<i>The stirrer does not work correctly.</i>	See <i>Stirrer - the stirrer does not rotate.</i> (page 46)
	<i>Temperature change of the measuring solution.</i>	The temperature of the measuring solution has a direct influence on the measured current. Therefore, a workplace close to an air conditioner or with direct exposure to sunlight should be avoided, since it can significantly change the temperature in the measuring solution.
	<i>The curves are generally not reproducible.</i>	See <i>Curve shape - the curves are very noisy.</i> and <i>Curve shape - the curves show a jump, a step or a flat line.</i>
<b>Calibration curve - the standard addition is too small / too big.</b>	<i>The concentration of the standard addition solution is not correct.</i>	Check the standard solution used for the determination. In case of doubts prepare a fresh standard solution. Also check whether the correct concentration for the standard solution is specified in the method.
	<i>The addition volume is not correct.</i>	Verify the standard addition volume used in the determination. In case of doubts repeat the determination with the correct volume. Also check whether the correct volume for the standard addition is specified in the method.
	<i>The total volume of the measuring solution is not correct.</i>	Verify the sample volume used in the determination. In case of doubts repeat the determination with the correct volume. Also check whether the correct sample volume is specified in the method.

<b>Problem</b>	<b>Cause</b>	<b>Remedy</b>
	<i>Pipetting has not been carried out correctly.</i>	<ul style="list-style-type: none"> <li>▪ The standard additions have to be carried out by the same person using the same pipette.</li> <li>▪ Read up on the correct pipetting in the manual of the pipette.</li> <li>▪ Control and recalibrate the pipette.</li> </ul>
	<i>The standard addition solution is too old.</i>	Prepare a fresh standard addition solution. Also consider the stability and age of the standard stock solution.
	<i>Standard addition solution does not conform to the analyte.</i>	Different species of an analyte, e.g. As <sup>III</sup> and As <sup>V</sup> , can show different sensitivity in a determination. Therefore, take care that the analyte in the standard addition solution chemically corresponds to the analyte to be determined in the sample.
	<i>The electrode was stored in water.</i>	Solid state electrodes should not be stored in ultrapure water, since this can affect the condition and sensitivity of the electrode. For recommended storage conditions refer to the respective application documentation.
	<i>The electrolyte is too old.</i>	Prepare a fresh electrolyte solution. Also consider the stability and age of the reagents used for the preparation.
	<i>The stirrer does not work correctly.</i>	See <i>Stirrer - the stirrer does not rotate.</i>
<b>Curve shape - the curves show a jump, a step or a flat line.</b>	<i>The potentiostat changes the current measuring range during the sweep.</i>	<p>In current measuring range <b>Auto</b>, the potentiostat changes to the next higher current range when the current exceeds 3 times the applied current range, and to the next lower current range when the measured current is lower than 0.05 times the applied current range.</p> <p>Change the current measuring range in the method from <b>Auto</b> to a fixed range (usually <b>±1 µA</b> or <b>±10 µA</b> show good results).</p>
	<i>The current measuring range is too low.</i>	The maximum current which can be measured in a fixed current range is 4 times the selected current range, e.g. in the ±1 µA current mea-



Problem	Cause	Remedy
		<p>measuring range the maximum current which is displayed correctly is <math>\pm 4 \mu\text{A}</math>. Please note that in square-wave and differential pulse measuring mode only potential differences are displayed, so the absolute measured current can be higher than what is displayed.</p> <p>Select the next higher current measuring range or consider using current measuring range <b>Auto</b>, and repeat the determination. Please note that with <b>Potential step / Sweep rate &lt; 20 ms</b> or <b>Potential step · Frequency &lt; 20 ms</b> the use of a fixed current range is recommended.</p>
	<p><i>Gas bubbles stick to one of the electrodes.</i></p>	<p>Remove the gas bubbles and check the method parameters to prevent the formation of more gas bubbles.</p>
<p><b>Curve shape - the curves are very noisy.</b></p>	<p><i>The electrode is not in a good condition.</i></p>	<p>Clean the electrode as recommended in the application documentation and repeat the determination. If the situation does not improve, replace the electrode by a new one.</p>
	<p><i>Moisture penetrated the SPE holder.</i></p>	<p>Remove the SPE from the holder and thoroughly dry the electrical connection for the SPE.</p>
	<p><i>The conductivity of the measuring solution is too low.</i></p>	<p>Verify the concentration of the electrolyte solution and the volume of electrolyte added for the application. In case of doubts prepare a fresh electrolyte and repeat the determination.</p>
	<p><i>The electrolyte is too old.</i></p>	<p>Prepare a fresh electrolyte solution. Also consider the stability and age of the reagents used for the preparation.</p>
	<p><i>The current measuring range is too high.</i></p>	<p>The resolution of the current measurement is 0.25% of the selected current measuring range. This means the higher the selected current measuring range the poorer the current resolution.</p> <p>Select the next lower current measuring range or consider using current measuring range <b>Auto</b>, and repeat the determination. Please</p>

Problem	Cause	Remedy
		note that with <b>Potential step / Sweep rate &lt; 20 ms</b> or <b>Potential step · Frequency &lt; 20 ms</b> the use of a fixed current range is recommended.
	<i>The electrode is not connected properly.</i>	Verify that the electrode is plugged in correctly.
	<i>Electrical contacts in the SPE holder corroded.</i>	If liquid has penetrated the SPE holder too often, the electrical contacts in the connection socket for the SPE can corrode. Contact your local Metrohm Service for the replacement of the SPE holder.
	<i>Electromagnetic radiation interferes.</i>	Other electronic equipment in the vicinity of the instrument may emit electromagnetic radiation which interferes with the measurement. Known sources of interference are e.g. AC adapters for laptops, power supply units for fluorescent lamps, high-frequency vacuum pumps.  In such a case, remove the source of interference or carry out the determination in a different location or consider the use of a Faraday cage which is connected to earth or ground.
<b>Curve shape - the curves show an unusual shape</b>	<i>The electrode surface was touched during assembly of the SPE.</i>	Always hold the SPE at the edges in order to avoid contact with the electrode surface.
	<i>Solution penetrated the SPE holder and short-circuits the electrodes in the connection socket.</i>	Disassemble the electrode holder. To remove corrosive chemicals, rinse everything with ultrapure water. Then thoroughly dry all parts. Take care that no water runs along the outside of the electrode shaft into the measuring head. Then thoroughly dry all parts. If the electrode connection socket is rinsed too, the shaft has to dry for a couple of hours before reassembling to ensure that no moisture is captured in the holder.
<b>No peak - neither the sample nor the standard addition shows a peak for the analyte.</b>	<i>Incorrect or not sufficient electrolyte.</i>	Check whether the correct and enough electrolyte was added for the application. Verify that the used electrolyte was prepared correctly.



Problem	Cause	Remedy
	<i>Wrong pH.</i>	In some applications the pH of the measuring solution can be critical. Check the respective application documentation for the recommended pH and measure the pH of the measuring solution.
	<i>Wrong method or incorrect method parameters.</i>	<p>Check that the method and voltammetric parameters used for the determination are correct.</p> <ul style="list-style-type: none"> <li>▪ Is the method suitable for the intended concentration?</li> <li>▪ Is potential and time for the potentiostatic pretreatment correct?</li> <li>▪ Is the expected peak position between <b>Start potential</b> and <b>End potential</b> of the sweep?</li> <li>▪ Is the <b>Potential step</b> small enough to have a sufficient resolution of the curve?</li> </ul>
	<i>Interference from the sample matrix.</i>	The analyte has to be present in ionic form and the measuring solution has to be free of interfering substances. For more details see <i>Chapter 7.1.2 Measuring solution (page 45)</i> .
	<i>Electrode is mounted in reverse position.</i>	<p>Check that the scTRACE Gold electrode (<i>see chapter 4.2.2, page 15</i>) or the SPE (<i>see chapter 4.2.3, page 16</i>) is plugged in with the correct orientation.</p> <ul style="list-style-type: none"> <li>▪ The scTRACE Gold has an anti-twist protection. Nevertheless, it is possible, with a little force, to mount the electrode incorrectly.</li> <li>▪ The SPE has no anti-twist protection. Make sure that the electrode surface and the symbol on the holder point in the same direction. Only in this position the electrode has electrical contact in the connection socket.</li> </ul>
	<i>Electrode cable is not correctly assembled.</i>	Check that the electrode cable ( <i>see chapter 4.2.5, page 19</i> ) is plugged in with the correct orientation. The cable has an anti-twist protection. Nevertheless, it is possible, with a little force, to mount it incorrectly.

<b>Problem</b>	<b>Cause</b>	<b>Remedy</b>
	<i>Electrode, electrode holder, electrode cable or potentiostat defective.</i>	Run the dummy cell test ( <i>see chapter 7.5, page 66</i> ) to verify that potentiostat and electrode cable are working correctly.  Replace the electrode by a new one and repeat the determination.
<b>No peak - the sample does not show a peak, but the standard addition is ok.</b>	<i>The sample does not contain the analyte in ionic form.</i>	A sample preparation has to be carried out to make the analyte available for the analysis. The kind of sample preparation depends on the analytical problem.
	<i>The concentration in the sample is below the limit of detection.</i>	Increase the deposition time (method parameter <b>Waiting time 1</b> or <b>Waiting time 2</b> ).
	<i>The sample is too diluted.</i>	Use a less diluted or undiluted sample.
	<i>No sample was added.</i>	Add a sufficient amount of sample and repeat the determination.
<b>No peak - the sample shows a peak, but the standard addition does not increase the peak.</b>	<i>Wrong standard addition solution.</i>	Verify that the correct standard solution with the correct concentration of analyte is used.
	<i>Standard addition solution does not contain the analyte.</i>	Verify that the correct standard stock solution and the appropriate volume was used for the preparation of the standard addition solution. In case of doubts prepare a fresh standard addition solution.
	<i>Concentration and/or volume of standard addition too small.</i>	Follow the recommendations in <i>Chapter 7.1.3 Quantification (page 46)</i> to adapt volume and/or concentration of the standard addition.
	<i>Standard addition solution not stable or too old.</i>	Prepare a fresh standard addition solution. Also consider the stability and age of the standard stock solution.
	<i>Standard addition solution does not conform to the analyte.</i>	Different species of an analyte, e.g. $\text{As}^{\text{III}}$ and $\text{As}^{\text{V}}$ , can show different sensitivity in a determination. Therefore, take care that the analyte in the standard addition solution chemically corresponds to the analyte to be determined in the sample.
	<i>The concentration in the sample is too high.</i>	Adapt the volume and/or concentration of the standard addition or dilute the sample. Con-



Problem	Cause	Remedy
	<p>The observed peak is not from the analyte.</p>	<p>sider the linear working range of the method (see chapter 7.4.1, page 60).</p> <ul style="list-style-type: none"> <li>▪ Adapt the evaluation so that the correct peak is evaluated (see <i>Adapting the base-line parameters for all curves</i> (page 30), <i>Adapting the base points for an individual curve</i> (page 31) or <i>Excluding a curve from the evaluation</i> (page 30)).</li> <li>▪ Identify the interference and remove it from the measuring solution.</li> </ul>
<p><b>Peak evaluation - the peaks are not or not correctly evaluated.</b></p>	<p><i>Peak shifted.</i></p>	<p>There are various reasons why a peak can shift (see <i>Peak position - the peak in the sample as well as for the standard addition has shifted.</i>). Identify the problem and eliminate it if possible.</p>
	<p><i>Wrong characteristic potential.</i></p>	<p>Adapt the method parameter <b>Characteristic potential</b> on the tab <b>Evaluation</b> in accordance with the peak position (see "<i>Adapting the peak recognition</i>", page 29).</p>
	<p><i>Wrong evaluation parameters.</i></p>	<p>The method parameters <b>Tolerance</b>, <b>Min. width</b>, <b>Max. width</b> and <b>Min. measured quantity</b> on the tab <b>Evaluation</b> are thresholds for the peak acceptance. Check these parameters and adapt them in accordance with the peak shape.</p>
	<p><i>Substance evaluation not active.</i></p>	<p>Make sure that the checkmark in the column <b>Active</b>, table <b>Substances</b> on the tab <b>Evaluation</b>, is set.</p>
	<p><i>Original curves are displayed.</i></p>	<p>Make sure that the option <b>Show original curves</b> under <b>Main menu ▶ View</b> is not checked.</p>
<p><b>Peak height - the replicative measurements differ significantly.</b></p>	<p><i>The electrode is not in a good condition.</i></p>	<p>Clean the electrode as recommended in the application documentation and repeat the determination. If the situation does not improve, replace the electrode by a new one.</p>
	<p><i>The curves are generally very noisy.</i></p>	<p>See <i>Curve shape - the curves are very noisy.</i></p>



<b>Problem</b>	<b>Cause</b>	<b>Remedy</b>
	<i>The method parameters are not suitable for the application problem.</i>	Identify the problem and adapt the voltammetric parameters and/or the electrolyte composition.
	<i>The stirrer does not work correctly.</i>	See <i>Stirrer - the stirrer does not rotate.</i>
<b>Peak position - the peak in the sample as well as for the standard addition has shifted.</b>	<i>Concentration of chloride in the measuring solution has changed.</i>	The potential of the reference electrode depends on the concentration of chloride in the measuring solution. If the sample already contains significant amounts of chloride, reduce the concentration of chloride in the electrolyte accordingly. If that is not possible or does not improve the situation, adapt the peak recognition according to the new peak position (see " <i>Adapting the peak recognition</i> ", page 29). In this case also the potentials for cyclovoltammetric and potentiostatic pretreatment may need to be adapted.
	<i>The electrode was stored in water.</i>	Solid state electrodes should not be stored in ultrapure water, since this can affect the condition and sensitivity of the electrode. For recommended storage conditions refer to the respective application documentation.
	<i>The electrode is too old.</i>	Replace the electrode with a new one.
<b>Peak position - the peak in the sample has shifted, but the standard addition is ok.</b>	<i>The evaluated peak in the sample is not the analyte.</i>	Adapt the peak recognition (see " <i>Adapting the peak recognition</i> ", page 29) in order to evaluate the correct peak.
	<i>Normal behavior if complex formation is involved.</i>	In some specific applications, in which complex formation of the analyte is involved, this is a normal behavior.
<b>Peak shape - double or multiple peaks</b>	<i>Another substance shows a peak close to the analyte.</i>	<ul style="list-style-type: none"> <li>▪ Identify the interference and remove it from the measuring solution.</li> <li>▪ If possible, adapt the electrolyte to get a better separation between the two peaks.</li> <li>▪ If possible, adapt the method parameters to minimize the interference by the additional peak.</li> </ul>



<b>Problem</b>	<b>Cause</b>	<b>Remedy</b>
	<i>The concentration of analyte is too high, the electrode is overloaded.</i>	Reduce the sample volume or use a more diluted sample. Also consider the linear working range of the method (see chapter 7.4.1, page 60).
	<i>Interference which leads to complex formation.</i>	Identify the interference and remove it from the measuring solution.
	<i>The electrolyte is too old.</i>	Prepare a fresh electrolyte solution. Also consider the stability and age of the reagents used for the preparation.
<b>Peak shape - the peak is cut</b>	<i>The current measuring range is too low.</i>	Select the next higher current measuring range or consider using current measuring range <b>Auto</b> .
<b>Peak shape - the peak looks strange.</b>	<i>Concentration in the measuring solution is too high.</i>	Reduce the sample volume or use a more diluted sample. Also consider the linear working range of the method (see chapter 7.4.1, page 60).
	<i>Interference from the sample matrix.</i>	Run a determination in standard solution to verify that the application works properly. <ul style="list-style-type: none"> <li>▪ If the peak shape in standard solution is not ok, clean the electrode as recommended in the respective application documentation. If that does not improve the situation, replace the electrode by a new one.</li> <li>▪ If the peak shape in standard solution is ok, identify the interference in the sample and remove it from the measuring solution.</li> </ul>
	<i>The method parameters are not correct.</i>	Check the voltammetric parameters, and adapt them if necessary.
<b>Result - the result is higher than expected</b>	<i>Blank or contamination</i>	<ul style="list-style-type: none"> <li>▪ Run a blank determination to determine the reagent blank. In case of blank problems check whether reagents with a better purity are available or reagents from a different source show lower blanks.</li> <li>▪ Be aware of contamination risks. Every surface, measuring vessel, electrode and other equipment in contact with sample or reagents can be contaminated.</li> </ul>

Problem	Cause	Remedy
		<ul style="list-style-type: none"> <li>▪ If a sample with low concentration is determined after a sample with very high concentrations, a cross-contamination can be expected. Run a blank determination in between the two samples to test the blank and clean the measuring cell.</li> </ul>
	<i>The standard additions are outside the linear working range.</i>	Make sure the sample peak and all peaks for the standard addition are within the linear working range of the method ( <i>see chapter 7.4.1, page 60</i> ).
	<i>Sample volume not correct.</i>	Verify that the sample was correctly diluted and the correct sample volume was pipetted into the measuring vessel. Also check that the correct <b>Sample volume</b> is specified in the method parameters on the tab <b>Determination</b> .
	<i>Standard addition not correct.</i>	See <i>Calibration curve - the calibration curve is not linear or poorly reproducible.</i> and <i>Calibration curve - the standard addition is too small / too big.</i>
<b>Result - the result is lower than expected.</b>	<i>The sample/analyte is not completely dissolved.</i>	The analyte has to be present in ionic form ( <i>see chapter 7.1.2, page 45</i> ). If the sample cannot be completely dissolved, an extraction might be an option. If a total metal concentration has to be determined, a digestion has to be carried out. The kind of digestion depends on the analytical problem.
	<i>The determined species is not stable.</i>	Some species, e.g. As <sup>III</sup> in the µg/L concentration range, are not stable over a longer period of time. In these cases the sample should be analyzed immediately after sampling. Whether and in which way a stabilization of the sample is possible, depends on the application problem.



Problem	Cause	Remedy
	<i>Interfering substances mask the analyte.</i>	<ul style="list-style-type: none"> <li>▪ A second peak of an interfering substance overlaps with the analyte peak. It depends on the individual case whether the interference can be eliminated. More information may be available in the respective application documentation.</li> <li>▪ Organic complexing agents or the formation of insoluble compounds prevent the presence of the analyte in ionic form. Whether and in which way a sample preparation is possible depends on the application problem.</li> </ul>
	<i>Sample volume not correct.</i>	Verify that the sample was correctly diluted and the correct sample volume was pipetted into the measuring vessel. Also check that the correct <b>Sample volume</b> is specified in the method parameters on the tab <b>Determination</b> .
	<i>Standard addition not correct.</i>	See <i>Calibration curve - the calibration curve is not linear or poorly reproducible.</i> and <i>Calibration curve - the standard addition is too small / too big.</i>

## 7.4 Some voltammetric troubles in detail

### 7.4.1 Linear working range

The quantification in voltammetric measurements is often carried out by the standard addition technique. A linear relation between the concentration and the peak height is a basic requirement for this calibration technique. The normal calibration function (*Figure 16 curve – –*) is linear over a certain concentration range. At higher concentrations the curve starts to flatten. When the standard additions are carried out take care that the sample peak as well as the peaks for the standard addition are within the linear range, otherwise the calculated concentration will be too high, as shown in *Figure 16-2*.

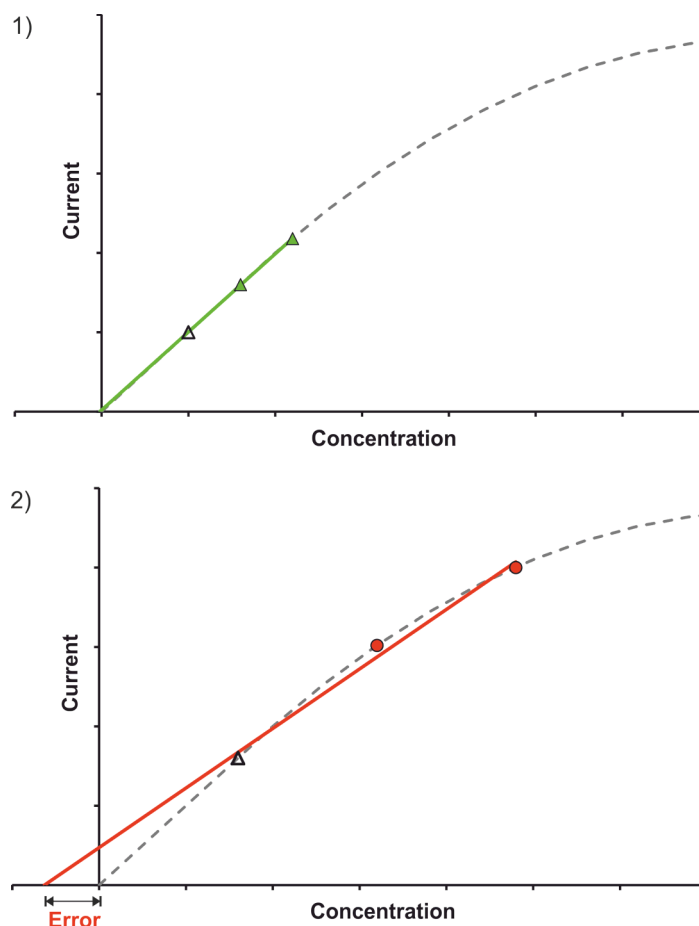

Figure 16 Good and bad standard addition curves

— — Calibration function	△ Peak height sample
<b>1 Good standard addition</b>	<b>2 Bad standard addition</b>
▲ Additions within linear working range	● Additions outside linear working range
— Standard addition calculation OK	— Standard addition calculation with error

#### 7.4.2 Potential range of an scTRACE Gold electrode

In this chapter the influence of chloride, oxygen and pH are described at the example of the scTRACE Gold electrode. But similar effects can also be observed with screen-printed electrodes using different electrode materials.

##### Influence of chloride

The background current of the scTRACE Gold shown in *Figure 17* shows three interesting sections. Section ② and ③ are not affected by a change in the chloride concentration. These sections are discussed in the subchapters *Influence of oxygen* and *Influence of pH*.

In section ① it can be seen that with higher chloride concentration the increase in the current starts at more negative potentials. This increasing

current at positive potentials is due to the oxidation of the electrode material, in this case gold. Oxidation of the electrode material means dissolution of the working electrode and as a consequence reduced lifetime of the electrode. The presence of chloride facilitates the oxidation of gold due to the formation of  $\text{AuCl}$  and  $\text{AuCl}_3$ . These complexes can form easier the more chloride is present in the measuring solution. Therefore, less positive potentials are necessary to oxidize the gold when the concentration of chloride is high.

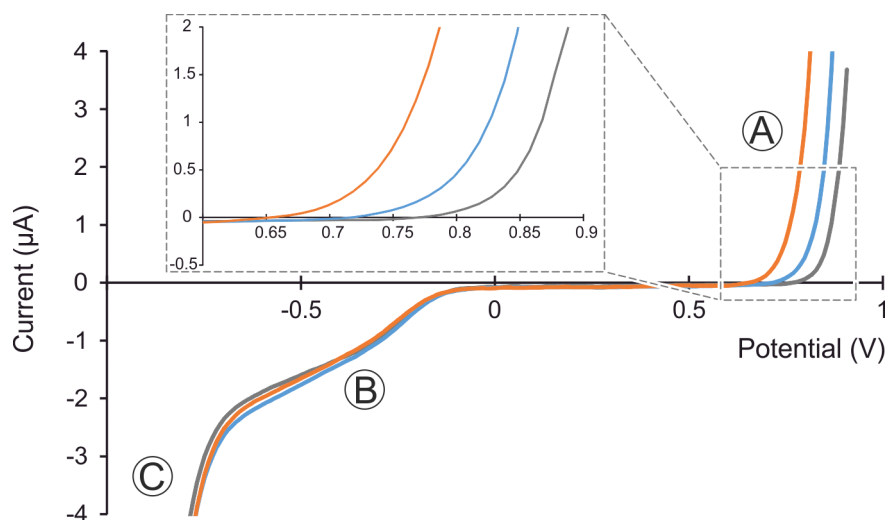

Figure 17 Influence of chloride concentration on the background current of the scTRACE Gold electrode. (Measuring solution  $c(\text{H}_2\text{SO}_4) = 1 \text{ mmol/L}$  with 5, 50 and 500 mmol/L KCl)

—  $c(\text{KCl}) = 5 \text{ mmol/L}$

—  $c(\text{KCl}) = 50 \text{ mmol/L}$

—  $c(\text{KCl}) = 500 \text{ mmol/L}$

For a determination this means care has to be taken about the chloride concentration of the sample. In the voltammetric parameters of the method rather positive potentials can be found in the cyclic voltammetric and potentiostatic pretreatment, which are used for cleaning purposes. These potentials are chosen with respect to the chloride concentration given by the electrolyte solution. If additional chloride, which exceeds the amount added by the electrolyte, is introduced by the sample matrix, either the concentration of chloride in the electrolyte has to be reduced or the potentials in the voltammetric parameters have to be adapted in order to avoid damage to the working electrode.

**NOTICE**

Similar effects can be observed with other anions forming complexes with the working electrode material, e.g. other halides, pseudo-halides, and hydroxides.

Besides the influence on the working electrode the concentration of chloride also affects the potential of the reference electrode. The following table shows the potential difference measured versus a classical Ag/AgCl reference electrode (6.0728.040; LL-Ag/AgCl,  $c(\text{KCl}) = 3 \text{ mol/L}$ ; standard potential (25 °C) vs. NHE 206.3 mV). The potentials versus Normal Hydrogen Electrode (NHE) shown in the table are calculated based on the standard potential of the Ag/AgCl electrode.

*Table 1 Reference potential scTRACE Gold electrode against chloride concentration*

<b>c(KCl)</b>	<b>Potential vs. Ag/AgCl (3 mol/L KCl)</b>	<b>Potential vs. NHE</b>
0.005 mol/L	154 mV	360 mV
0.01 mol/L	134 mV	340 mV
0.025 mol/L	118 mV	324 mV
0.05 mol/L	102 mV	308 mV
0.1 mol/L	85 mV	291 mV
0.25 mol/L	63 mV	269 mV
0.5 mol/L	47 mV	253 mV
1 mol/L	30 mV	236 mV
3 mol/L	1 mV	207 mV

**Influence of oxygen**

The influence of oxygen can be observed in section ③ of the curve shown in *Figure 18*. Section ④ and ⑤ are not affected by the presence of oxygen. These sections are discussed in the subchapters *Influence of chloride* and *Influence of pH*.

At potentials more negative than -0.2 V the first step of the oxygen reduction takes place:  $\text{O}_2 + 2 \text{H}^+ + 2 \text{e}^- \rightarrow \text{H}_2\text{O}_2$ . The second step would be at more negative potentials and cannot be registered under these conditions (electrode type, electrolyte).

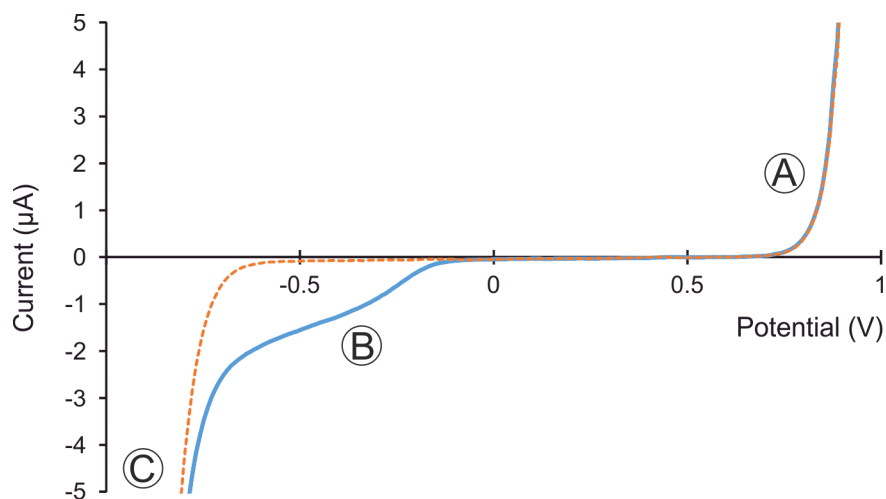

Figure 18 Influence of oxygen on the background current of the scTRACE Gold electrode. (Measuring solution:  $c(\text{H}_2\text{SO}_4) = 1 \text{ mmol/L}$ ,  $c(\text{KCl}) = 50 \text{ mmol/L}$ )

— with oxygen

- - - after 5 min purging with nitrogen

For a determination that means all substances which show a peak more positive than  $-0.2 \text{ V}$  can be determined without purging the measuring solution. For substances which show a peak more negative than  $-0.2 \text{ V}$  oxygen will interfere. The interference can be either removed from the measuring solution by purging or, in some cases, can be suppressed by the choice of voltammetric measuring technique (fast square-wave or linear sweep voltammetry).

### Influence of pH

The major influence of the pH can be observed in section © of the curve shown in Figure 19. Section © is discussed in subchapter *Influence of oxygen* and section © to a great extent in the subchapter *Influence of chloride*. What affects the background current in section © in slightly acid and alkaline solution in addition to what is already described for the chloride, is the formation of  $\text{Au}(\text{OH})_3$ .

The big drop in the current in section © is related to the reduction of the electrolyte. The easiest component in the electrolyte to be reduced is  $\text{H}^+$ . The reaction taking place is:  $2 \text{H}_3\text{O}^+ + 2 \text{e}^- \rightarrow \text{H}_2 + 2 \text{H}_2\text{O}$ . Since the concentration of  $\text{H}^+$  is the highest in the measuring solution with pH 2, the reaction already becomes obvious at potentials more negative than  $-0.5 \text{ V}$ . In only slightly acid (pH 5) or alkaline (pH 12) solution the concentration of  $\text{H}^+$  is significantly smaller, therefore a significantly more negative potential is required to have the same rate of  $\text{H}^+$  reduced.



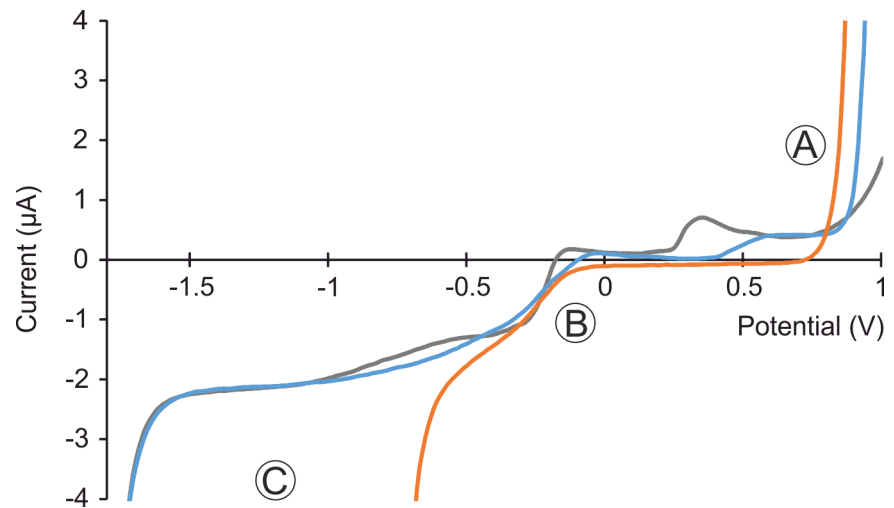

Figure 19 Influence of pH on the background current of the scTRACE Gold electrode.

— ~ pH 2  
(c(KCl) = 50 mmol/L, c(H<sub>2</sub>SO<sub>4</sub>) = 10 mmol/L)

— ~ pH 5 (c(KCl) = 50 mmol/L)

— ~ pH 12  
(c(KCl) = 50 mmol/L, c(NaOH) = 10 mmol/L)

For a determination that means that only substances which show a peak more positive than -0.5 V can be determined in an acid electrolyte. At more negative potentials the current deriving from the H<sup>+</sup> reduction will overlay any other analytical signal. If a neutral or alkaline electrolyte can be used for the application, also substances showing a peak between -0.5 V and -1.5 V can be determined.



## 7.5 Dummy cell test

The dummy cell (6.02813.000) is an electronic circuit simulating an electrochemical cell. It allows to test the potentiostat independent from electrodes and applications.

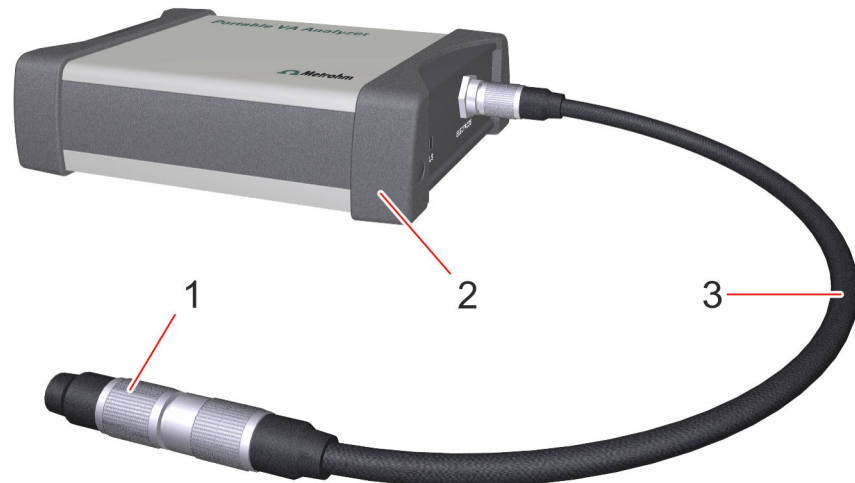

Figure 20 946 Portable VA Analyzer - potentiostat connected to the dummy cell

**1** Dummy cell (6.02813.000)

**2** Potentiostat

**3** Electrode cable (6.02135.000)

- 1** Disconnect the electrode cable (6.02135.000) from the measuring stand, but leave the cable connected to the potentiostat.
- 2** Plug in the dummy cell to the female connector of the electrode cable.

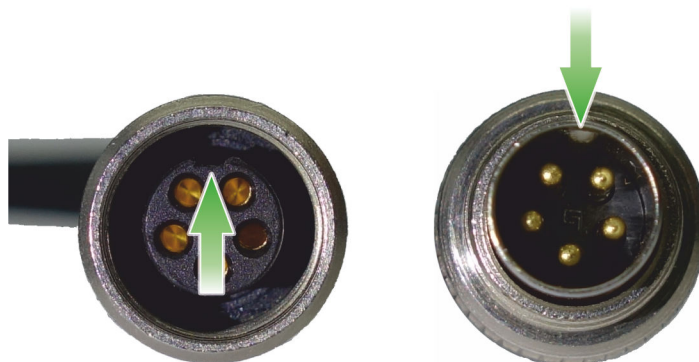

Take care of the orientation of the plug and tighten the screw to secure the connection.

- 3 Connect the instrument to the software as described in *Chapter 4.4 Connecting the software with the instrument (page 22)*.
- 4 Load the example method **Dummy cell test.detp** (see "Loading a method", page 23).
- 5 Click on  or **Menu bar ▶ Devices ▶ Start** to start the dummy cell test.

### Example of a dummy cell test measurement

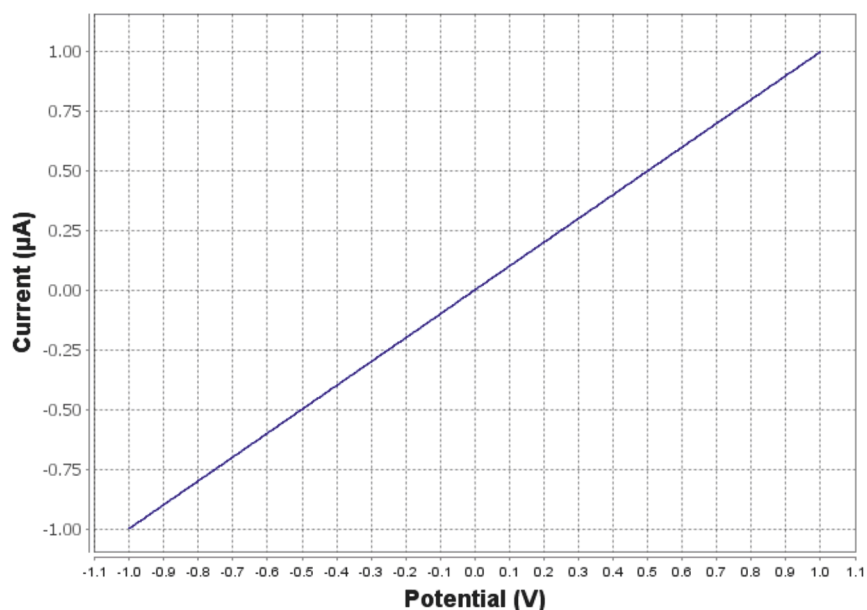

### Criteria to assess the dummy cell measurement

- The curve must be a straight line, without spikes or steps.
- At -1.0 V the current must be  $-0.89 - 1.09 \mu\text{A}$ .
- At +1.0 V the current must be  $0.89 - 1.09 \mu\text{A}$ .

To read out the exact current value at a specific potential, point the cursor on the curve. Below the cursor the software will display the name of the curve as well as potential and current at the specific point, e.g.

**LSV\_0001\_sample\_rep\_01: (-1.0, -0.996)**. The first value in the brackets is the potential, the second value the current.



#### NOTICE

If one of these criteria is not fulfilled, contact the local Metrohm Service.



## 8 Technical specifications

### 8.1 Potentiostat

<i>Power supply</i>	Li-ion battery (2300 mAh); USB; DC charger adapter compatible (5 V DC, 1 A)
<i>PC interface</i>	USB, RS232
<i>Operating modes</i>	Potentiostat
<i>DC potential range</i>	$\pm 4.096$ V
<i>Current ranges</i>	$\pm 1$ nA to $\pm 10$ mA (8 ranges)
<i>Maximum measurable current</i>	40 mA
<i>Voltage ranges</i>	$\pm 100$ mV to $\pm 1$ V (2 ranges)
<i>Rise time</i>	20 $\mu$ s
<i>Applied potential resolution</i>	1 mV
<i>Measured current resolution</i>	0.025% of current range 1 pA on lowest current range
<i>Applied current resolution</i>	0.1% of current output range
<i>Measured potential resolution</i>	0.012% of potential range
<i>Potential accuracy</i>	$\pm 0.2\%$
<i>Current accuracy</i>	$\leq 0.5\%$ of current range at 100 nA to 10 mA
<i>External inputs/outputs</i>	Iout, Eout 2 analog inputs 1 analog output 2 digital input/outputs TX, RX, RTS signals for RS-232 connection
<i>LED indicators</i>	Power, Battery status, Measuring
<i>Dimensions</i>	
<i>Length</i>	132 mm
<i>Width</i>	100 mm
<i>Height</i>	36 mm

<i>Weight</i>	480 g
<i>Housing material</i>	
<i>Corpus</i>	Aluminum alloy
<i>End cover</i>	Zinc alloy
<i>Impact protection seal and decor strips</i>	TPE

## 8.2 Measuring stand

<i>Dimensions</i>	
<i>Length</i>	116 mm
<i>Width</i>	104 mm
<i>Height</i>	148 mm
<i>Weight</i>	464 g (scTRACE Gold) 478 g (SPE)
<i>Housing material</i>	
<i>Base plate and measuring head</i>	PETP (Polyethyleneterephthalate)
<i>Transparent ring</i>	PMMA (Polymethylmethacrylate)

## 8.3 Stirrer

<i>Stirring rate</i>	500 - 4000 min <sup>-1</sup>
<i>Accuracy</i>	± 10%
<i>Stability</i>	± 2%



## 8.4 I/O connector

Table 2 I/O connector assignment

Line	Assignment	Cable (6.02135.010)
9	DIO 1	Blue 1 (Purge)
10	DIO 2	Blue 2 (Digital output 2)
12	Ground	Green $\perp$

## 8.5 Safety specifications



This instrument fulfills the following electrical safety requirements:

CE marking in accordance with the EU directives:

- 2014/35/EC (Low Voltage Directive, LVD)
- 2014/30/EC (EMC Directive, EMC)

*Safety instructions*

This document contains safety instructions which have to be followed by the user in order to ensure safe operation of the instrument.

## 8.6 Ambient temperature

*Normal function range* 0 - +45 °C (at a maximum of 85% relative humidity)

*Storage* -40 - +70 °C

*Transport* -40 - +70 °C

## 8.7 Reference conditions

*Ambient temperature* +25 °C ( $\pm 3$  °C)

*Relative humidity*  $\leq 60\%$

*Operating temperature status* Instrument in operation at least 30 min



## **8.8 Connection**

*Connection*                      USB (version 1.1 or higher)





# Index

## B

Base plate ..... 6, 7  
 Assembly ..... 19  
 Cleaning ..... 43  
 Base points ..... 31  
 Baseline ..... 30  
 Battery ..... 5, 20, 21

## C

Connect button ..... 11  
 Curves menu ..... 10  
 Curves subwindow ..... 9, 13

## D

Default workplace ..... 11  
 Determination  
 Load ..... 24  
 Save ..... 25  
 Start ..... 25, 36  
 Devices menu ..... 10  
 Disconnect button ..... 11  
 Dummy cell ..... 66  
 Dummy cell test criteria ..... 67

## E

Edit method parameters button ..... 12  
 Electrode cable ..... 19, 66  
 Connector ..... 5, 6, 7, 19  
 Electrostatic charge ..... 2  
 Exclude curve ..... 30

## F

File menu ..... 10  
 Final result unit ..... 29

## G

Graphics subwindow ..... 9, 13

## H

Help menu ..... 10  
 Hold button ..... 11

## I

I/O cable connector ..... 5

## L

Language menu ..... 10  
 Live curve subwindow ..... 9, 13  
 Load determination button ..... 10  
 Load method button ..... 10

## M

Measuring head ..... 34  
 Assembly ..... 15, 19  
 Cleaning ..... 44  
 Measuring head scTRACE Gold ... 6  
 Assembly ..... 15  
 Measuring head SPE ..... 7  
 Assembly ..... 16  
 Measuring solution ..... 45  
 Measuring stand ..... 19  
 Assembly ..... 18  
 Cleaning ..... 44  
 Operation ..... 34  
 Measuring stand scTRACE Gold .. 6  
 Measuring stand SPE ..... 7  
 Measuring vessel ..... 6, 7  
 Menu bar ..... 9, 10  
 Messages subwindow ..... 9, 12  
 Method  
 Load ..... 23  
 Save ..... 24  
 Method menu ..... 10  
 Mosaic workplace ..... 11

## N

New method button ..... 10  
 Nut ..... 8, 17

## O

O-ring ..... 6, 7  
 ON/OFF button ..... 5

## P

PDF report ..... 10, 12  
 Peak recognition ..... 29  
 Pipetting opening ..... 6, 7, 26, 37  
 Potentiostat ..... 19, 20, 66  
 Cleaning ..... 44  
 Front view ..... 5  
 Rear view ..... 5

## Print

Method ..... 28  
 Result ..... 27

## R

Reports menu ..... 10  
 Reprocess button ..... 12  
 Results subwindow ..... 9, 13  
 Run subwindow ..... 9, 12

## S

Safety instructions ..... 2  
 Sample size ..... 32  
 Screen-printed electrode → see SPE  
 ..... 7  
 scTRACE Gold ..... 6, 34, 43  
 Activation ..... 35  
 Assembly ..... 15  
 Cleaning ..... 36, 38, 39, 44  
 Remove ..... 40  
 Service ..... 2  
 Silicone seal ..... 8, 17  
 SPE ..... 7, 17  
 Assembly ..... 16  
 Cleaning ..... 44  
 Remove ..... 41  
 SPE holder ..... 7, 8  
 Standard addition ..... 31, 46  
 Start button ..... 11  
 Status bar ..... 9, 12  
 Status LED ..... 5, 22  
 Stirrer ..... 6, 7, 34  
 Assembly ..... 15  
 Remove ..... 43  
 Stop button ..... 11  
 Supply voltage ..... 2  
 Supporting ring ..... 8, 17

## T

Tabs workplace ..... 11  
 Toolbar ..... 9, 10  
 Transparent ring ..... 6, 7, 34, 43  
 Assembly ..... 19  
 Cleaning ..... 43

## U

USB connection ..... 22  
 USB connector ..... 5  
 USB power supply ..... 21, 22

## V

View menu ..... 10

## W

Wrench ..... 15, 43