

# 905 Titrande



## Manual

8.905.8003EN / 2022-01-12





Metrohm AG  
CH-9100 Herisau  
Switzerland  
+41 71 353 85 85  
info@metrohm.com  
www.metrohm.com

# 905 Titrando

## Manual

Technical Communication  
Metrohm AG  
CH-9100 Herisau

This documentation is protected by copyright. All rights reserved.

This documentation has been prepared with great care. However, errors can never be entirely ruled out. Please send comments regarding possible errors to the address above.

### **Disclaimer**

Deficiencies arising from circumstances that are not the responsibility of Metrohm, such as improper storage or improper use, etc., are expressly excluded from the warranty. Unauthorized modifications to the product (e.g. conversions or attachments) exclude any liability on the part of the manufacturer for resulting damage and its consequences. Instructions and notes in the Metrohm product documentation must be strictly followed. Otherwise, Metrohm's liability is excluded.

# Table of contents

<b>1</b>	<b>Introduction</b>	<b>1</b>
1.1	The Titrando system .....	1
1.2	Instrument description .....	2
1.3	Titration modes – Measuring modes – Dosing commands .....	3
1.4	About the documentation .....	5
1.4.1	Symbols and conventions .....	5
1.5	Safety instructions .....	6
1.5.1	General notes on safety .....	6
1.5.2	Electrical safety .....	6
1.5.3	Working with liquids .....	7
1.5.4	Flammable solvents and chemicals .....	7
1.5.5	Recycling and disposal .....	7
<b>2</b>	<b>Overview of the instrument</b>	<b>8</b>
<b>3</b>	<b>Installation</b>	<b>10</b>
3.1	Setting up the instrument .....	10
3.1.1	Packaging .....	10
3.1.2	Checks .....	10
3.1.3	Location .....	10
3.2	Connecting a controller .....	10
3.2.1	Operation .....	10
3.3	Connecting MSB devices .....	15
3.3.1	Connecting a dosing device .....	16
3.3.2	Connecting a stirrer or titration stand .....	17
3.3.3	Connecting a Remote Box .....	18
3.4	Connecting USB devices .....	19
3.4.1	General .....	19
3.4.2	Connecting a USB hub .....	20
3.4.3	Connecting a printer .....	20
3.4.4	Connecting a balance .....	21
3.4.5	Connecting a PC keyboard (only for operation with Touch Control) .....	22
3.4.6	Connecting a barcode reader .....	23
3.5	Connecting sensors .....	24
3.5.1	Connecting a pH, metal or ion-selective electrode .....	24
3.5.2	Connecting a reference electrode .....	25
3.5.3	Connecting a polarizable electrode .....	25
3.5.4	Connecting a temperature sensor or an electrode with integrated temperature sensor .....	26



3.5.5	Connecting the iConnect .....	26
3.5.6	Differential potentiometry .....	30
<b>4</b>	<b>Setting up the titration vessel</b> .....	<b>31</b>
4.1	General .....	31
<b>5</b>	<b>Operation and maintenance</b> .....	<b>32</b>
5.1	General notes .....	32
5.1.1	Care .....	32
5.1.2	Maintenance by Metrohm Service .....	32
<b>6</b>	<b>Troubleshooting</b> .....	<b>33</b>
6.1	General .....	33
6.2	SET titration .....	33
6.2.1	.....	33
<b>7</b>	<b>Appendix</b> .....	<b>35</b>
7.1	Remote interface .....	35
7.1.1	Pin assignment of the remote interface .....	35
<b>8</b>	<b>Technical specifications</b> .....	<b>39</b>
8.1	Measuring interface .....	39
8.1.1	Potentiometry .....	39
8.1.2	Temperature .....	39
8.1.3	Polarizer .....	40
8.2	Power connection .....	41
8.3	Ambient temperature .....	41
8.4	Reference conditions .....	41
8.5	Dimensions .....	41
8.6	Interfaces .....	42
<b>9</b>	<b>Accessories</b> .....	<b>43</b>
	<b>Index</b> .....	<b>44</b>

## Table of figures

Figure 1	The Titrand system .....	1
Figure 2	Front 905 Titrand .....	8
Figure 3	Rear 905 Titrand .....	9
Figure 4	Connecting the Touch Control .....	11
Figure 5	Connecting the computer .....	14
Figure 6	MSB connections .....	15
Figure 7	Connecting a dosing device .....	17
Figure 8	Connecting an MSB stirrer .....	18
Figure 9	Connecting the rod stirrer to the titration stand .....	18
Figure 10	Connecting the Remote Box .....	19
Figure 11	Connecting a printer .....	21
Figure 12	Connecting a pH, metal or ion-selective electrode .....	24
Figure 13	Connecting a reference electrode .....	25
Figure 14	Connecting a polarizable electrode .....	25
Figure 15	Connecting a temperature sensor or an electrode with integrated temperature sensor .....	26
Figure 16	Plugging in the mini USB adapter cable .....	27
Figure 17	Plugging in the 854 iConnect .....	27
Figure 18	Removing the protective cap .....	28
Figure 19	Aligning the guide pin .....	28
Figure 20	Attaching the electrode .....	28
Figure 21	Unplugging the 854 iConnect .....	29
Figure 22	Schematic configuration of magnetic stirrer, electrode and buret tip during a titration. a) stirring direction clockwise, b) stirring direction counterclockwise. ....	31
Figure 23	Connectors of the Remote Box .....	35
Figure 24	Pin assignment of remote socket and remote plug .....	35





# 1 Introduction

## 1.1 The Titrando system

The Titrando is the heart of the modular Titrando system. Operation is carried out either by a Touch Control with a touch-sensitive screen ("stand-alone titrator") or by a computer with a corresponding software.

A Titrando system can contain numerous, various kinds of instruments. The following figure provides an overview of the peripheral devices you can connect to the 905 Titrando.

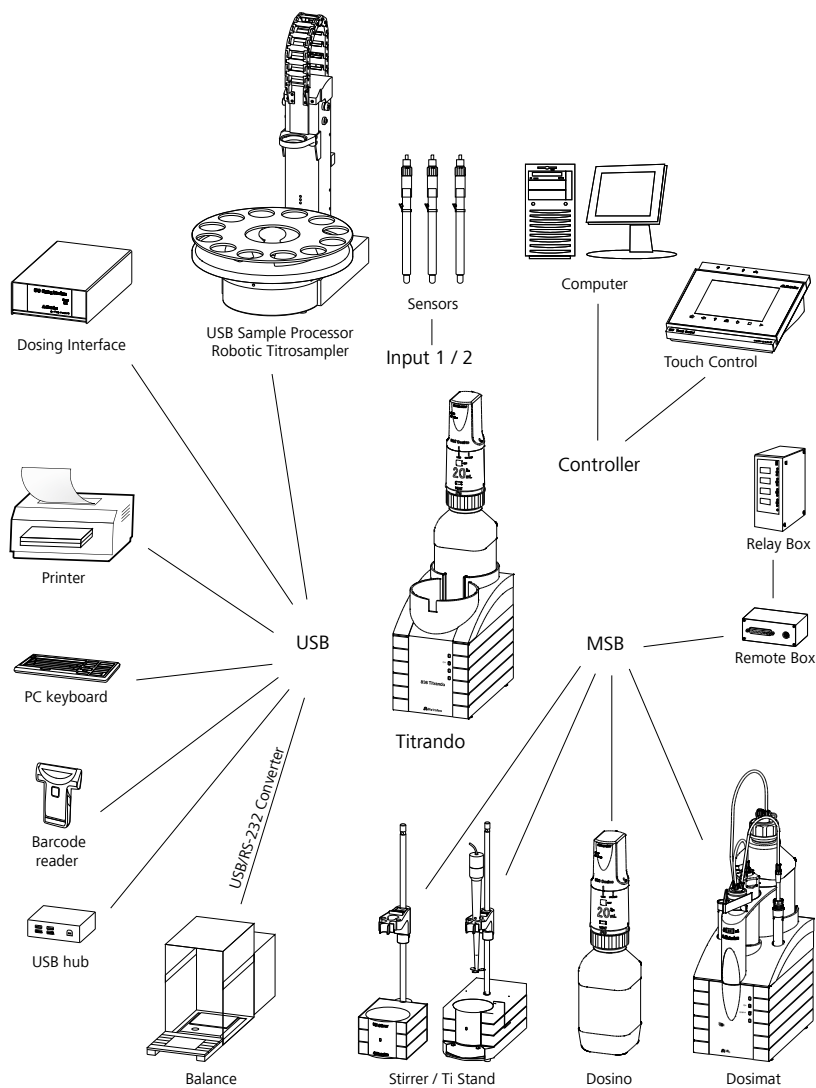

Figure 1 The Titrando system



Up to three control instruments (Titrandos, Dosing Interface, USB Sample Processor, etc.) can be controlled via USB connection during operation with the 900 Touch Control.

You can request information on special applications in the "Application Bulletins" and "Application Notes", available free of charge via the Metrohm representative responsible. Various monographs on the subjects of titration techniques and electrodes are also available.

Updating the device software is described in the help of the corresponding PC software.

## 1.2 Instrument description

The 905 Titrandos have the following characteristics:

- **Operation**

Operation is carried out by means of a touch-sensitive Touch Control or with a high-performance PC software.

- **MSB connectors**

Four MSB connectors (Metrohm Serial Bus) for connecting dosing devices (Dosimat with exchange unit or Dosino with dosing unit), stirrers, titration stands and Remote Boxes.

- **USB connectors**

Two USB connectors, through which devices such as printers, PC keyboards, barcode readers or additional control devices (USB Sample Processor, Titrandos, Dosing Interface, etc.) can be connected.

- **Measuring interface**

Depending on the model version, one or two measuring interface(s).

Each measuring interface has one measuring input each for:

- a potentiometric electrode (pH, metal or ion-selective electrode)
- a separate reference electrode
- a temperature sensor (Pt1000 or NTC)
- a polarizable electrode
- an iConnect (measuring interface for electrodes with integrated data chip, so-called iTrodes)

## 1.3 Titration modes – Measuring modes – Dosing commands

The 905 Titrande supports the following titration modes, measuring modes and dosing commands:

- **DET**

Dynamic equivalence point titration. The reagent is added in variable volume steps.

Measuring modes:

- **pH** (pH measurement)
- **U** (potentiometric voltage measurement)
- **Ipol** (voltametric measurement with selectable polarization current)
- **Upol** (amperometric measurement with selectable polarization voltage)

- **MET**

Monotonic equivalence point titration. The reagent is added in constant volume steps.

Measuring modes:

- **pH** (pH measurement)
- **U** (potentiometric voltage measurement)
- **Ipol** (voltametric measurement with selectable polarization current)
- **Upol** (amperometric measurement with selectable polarization voltage)

- **SET**

Endpoint titration at one or two specified endpoints.

Measuring modes:

- **pH** (pH measurement)
- **U** (potentiometric voltage measurement)
- **Ipol** (voltametric measurement with selectable polarization current)
- **Upol** (amperometric measurement with selectable polarization voltage)



- **MEAS**

The following measuring modes can be selected for measurements:

- **pH** (pH measurement)
- **U** (potentiometric voltage measurement)
- **Ip<sub>ol</sub>** (voltametric measurement with selectable polarization current)
- **Up<sub>ol</sub>** (amperometric measurement with selectable polarization voltage)
- **Conc** (concentration measurement with or without standard addition)
- **T** (temperature measurement)

- **STDADD**

The measuring modes for standard addition are listed separately only in *tiamo*<sup>TM</sup>. In Touch Control they are integrated in the measuring mode MEAS Conc.

The following measuring modes can be selected for measurements:

- **auto** (automatic addition of the standard addition solution by specifying a potential difference)
- **dos** (automatic addition of the standard addition solution by specifying the single volume increments)
- **man** (manual addition of the standard addition solution)

- **CAL**

Electrode calibration.

Measuring mode:

- **pH** (calibration of pH electrodes)
- **Conc** (calibration of ion-selective electrodes)

- **ELT**

Electrode test for pH electrodes.

This mode is listed separately only in *tiamo*<sup>TM</sup>. In Touch Control, the electrode test is a component part of the CAL calibration mode.

- **Dosing commands**

The following commands for dosing can be selected:

- **PREP** (rinsing the cylinder and tubings of an exchange unit or dosing unit)
- **EMPTY** (emptying the cylinder and tubings of a dosing unit)
- **ADD** (dosing a specified volume)
- **LQH** (carrying out complex dosing tasks with a Dosino)

## 1.4 About the documentation



### CAUTION

Please read through this documentation carefully before putting the instrument into operation. The documentation contains information and warnings which the user must follow in order to ensure safe operation of the instrument.

### 1.4.1 Symbols and conventions

The following symbols and formatting may appear in this documentation:

(5-12)

#### Cross-reference to figure legend

The first number refers to the figure number, the second to the instrument part in the figure.

1

#### Instruction step

Carry out these steps in the sequence shown.

**Method**

**Dialog text, parameter** in the software

**File ► New**

Menu or menu item

**[Next]**

**Button or key**



#### WARNING

This symbol draws attention to a possible life-threatening hazard or risk of injury.



#### WARNING

This symbol draws attention to a possible hazard due to electrical current.



#### WARNING

This symbol draws attention to a possible hazard due to heat or hot instrument parts.



#### WARNING

This symbol draws attention to a possible biological hazard.



#### CAUTION

This symbol draws attention to possible damage to instruments or instrument parts.

**NOTE**

This symbol highlights additional information and tips.

## 1.5 Safety instructions

### 1.5.1 General notes on safety

**WARNING**

Operate this instrument only according to the information contained in this documentation.

This instrument left the factory in a flawless state in terms of technical safety. To maintain this state and ensure non-hazardous operation of the instrument, the following instructions must be observed carefully.

### 1.5.2 Electrical safety

The electrical safety when working with the instrument is ensured as part of the international standard IEC 61010.

**WARNING**

Only personnel qualified by Metrohm are authorized to carry out service work on electronic components.

**WARNING**

Never open the housing of the instrument. The instrument could be damaged by this. There is also a risk of serious injury if live components are touched.

There are no parts inside the housing which can be serviced or replaced by the user.

#### Supply voltage

**WARNING**

An incorrect supply voltage can damage the instrument.

Only operate this instrument with a supply voltage specified for it (see rear panel of the instrument).

## Protection against electrostatic charges



### WARNING

Electronic components are sensitive to electrostatic charges and can be destroyed by discharges.

Do not fail to pull the power cord out of the power socket before you set up or disconnect electrical plug connections at the rear of the instrument.

### 1.5.3 Working with liquids



### CAUTION

Periodically check all system connections for leaks. Observe the relevant regulations in respect to working with flammable and/or toxic fluids and their disposal.

### 1.5.4 Flammable solvents and chemicals



### WARNING

All relevant safety measures are to be observed when working with flammable solvents and chemicals.

- Set up the instrument in a well-ventilated location (e.g. fume cupboard).
- Keep all sources of flame far from the workplace.
- Clean up spilled liquids and solids immediately.
- Follow the safety instructions of the chemical manufacturer.

### 1.5.5 Recycling and disposal

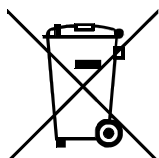

This product is covered by European Directive 2012/19/EU, WEEE – Waste Electrical and Electronic Equipment.

The correct disposal of your old instrument will help to prevent negative effects on the environment and public health.

More details about the disposal of your old instrument can be obtained from your local authorities, from waste disposal companies or from your local dealer.

## 2 Overview of the instrument

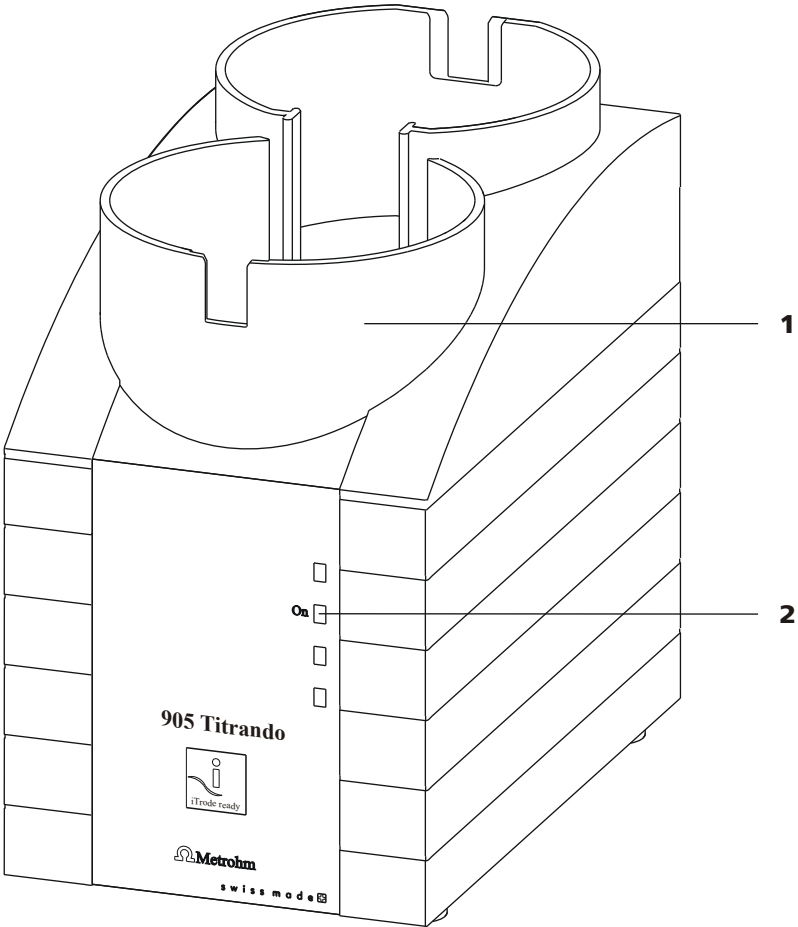

Figure 2 Front 905 Titrandometer

**1 Bottle holder**  
With holding clamps, for two reagent bottles.

**2 "On" LED**  
Lights up when the Titrandometer is ready for operation.



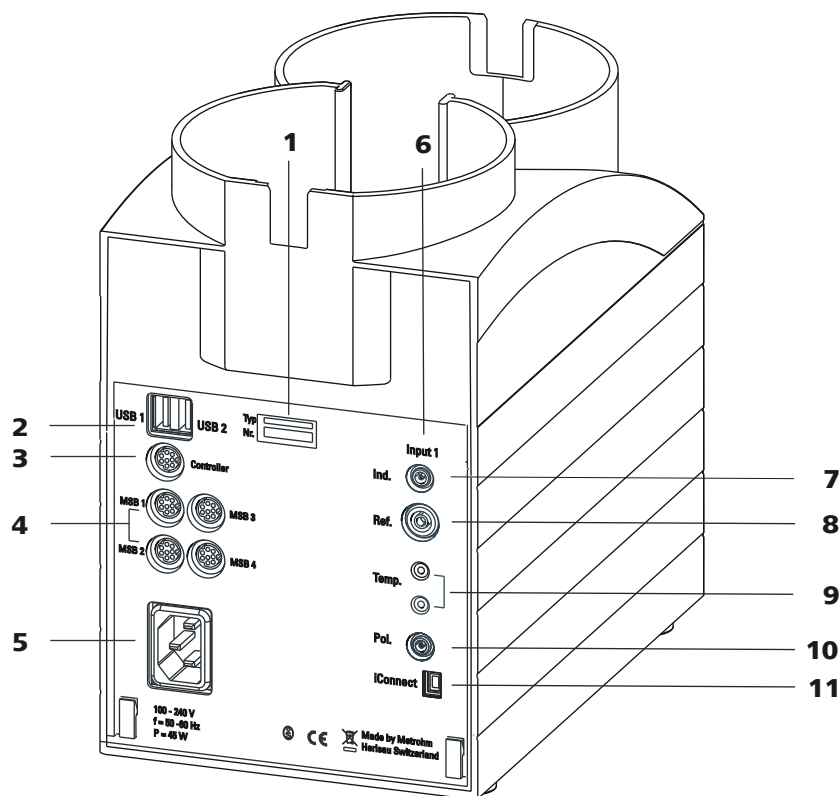

Figure 3 Rear 905 Titrand

<p><b>1 Type plate</b> Contains specifications concerning supply voltage, instrument type and serial number.</p>	<p><b>2 USB connector (USB 1 and USB 2)</b> USB ports (type A) for connecting printer, keyboard, barcode reader, additional Titrandos, USB Sample Processor, etc.</p>
<p><b>3 Connector (Controller)</b> For connecting a Touch Control or a PC with installed PC software. Mini DIN, 9-pin.</p>	<p><b>4 MSB connector (MSB 1 to MSB 4)</b> Metrohm Serial Bus. For connecting external dosing devices, stirrers or Remote Boxes. Mini DIN, 9-pin.</p>
<p><b>5 Power socket</b></p>	<p><b>6 Measuring interface 1 (Input 1)</b></p>
<p><b>7 Electrode connector (Ind.)</b> For connecting pH, metal or ion-selective electrodes with integrated or separated reference electrode. Socket F.</p>	<p><b>8 Electrode connector (Ref.)</b> For connecting reference electrodes, e.g. Ag/AgCl reference electrode. Socket B, 4 mm.</p>
<p><b>9 Temperature sensor connector (Temp.)</b> For connecting temperature sensors (Pt1000 or NTC). Two B sockets, 2 mm.</p>	<p><b>10 Electrode connector (Pol.)</b> For connecting polarizable electrodes, e.g. double Pt wire electrodes. Socket F.</p>
<p><b>11 Electrode connector (iConnect)</b> For connecting electrodes with integrated data chip (iTrodes).</p>	



### 3.2.1.1 Connecting a Touch Control



#### NOTICE

The plug is protected against accidental disconnection of the cable by means of a pull-out protection feature. If you wish to pull out the plug, you first need to pull back the outer plug sleeve marked with arrows.

Connect the Touch Control as follows:

- 1 ▪ Insert the plug of the Touch Control connection cable into the **Controller** socket.

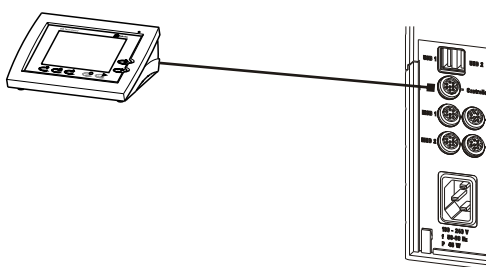

Figure 4 Connecting the Touch Control

- 2 ▪ Connect the MSB devices (*see chapter 3.3, page 15*).
- Connect the USB devices (*see chapter 3.4, page 19*).
- 3 ▪ Connect the Titrando to the power grid (*see chapter 3.2.1.2, page 12*).
- 4 ▪ Switch on the Touch Control.

The Touch Control power supply is supplied through the Titrando. Automatic system tests are performed on both instruments at the time of activation. The **On** LED on the front of the Titrando lights up when the system test has been completed and the instrument is ready for operation.



### CAUTION

The Touch Control must be shut down properly by deactivation with the power switch on the rear of the instrument before the power supply is interrupted. If this is not done, then there is a danger of data loss. Because of the fact that the power supply for the Touch Control is provided through the Titrande, you must never disconnect the Titrande from the power grid (e.g. by deactivating with a connector strip) before you have deactivated the Touch Control.

If you would prefer not to position the Touch Control directly next to the Titrande, then you can lengthen the connection with the 6.2151.010 cable. The maximum connection length permitted is 5 m.

#### 3.2.1.2 Connecting the instrument to the power grid



### WARNING

#### Electric shock from electrical potential

Risk of injury by touching live components or through moisture on live parts.

- Never open the housing of the instrument while the power cord is still connected.
- Protect live parts (e.g. power supply unit, power cord, connection sockets) against moisture.
- Unplug the power plug immediately if you suspect that moisture has gotten inside the instrument.
- Only personnel who have been issued Metrohm qualifications may perform service and repair work on electrical and electronic parts.

#### Connecting the power cord

##### Accessories

Power cord with the following specifications:

- Length: max. 2 m
- Number of cores: 3, with protective conductor
- Instrument plug: IEC 60320 type C13
- Conductor cross-section 3x min. 0.75 mm<sup>2</sup> / 18 AWG
- Power plug:
  - according to customer requirement (6.2122.XX0)
  - min. 10 A

**NOTICE**

Do not use a not permitted power cord!

**1 Plugging in the power cord**

- Plug the power cord into the instrument's power socket.
- Connect the power cord to the power grid.

**3.2.1.3 Connecting a computer**

The 905 Titrande requires a USB connection to a computer in order to be able to be controlled by a computer software. Using a 6.2151.000 controller cable, the instrument can be connected directly, either to a USB socket on a computer, to a connected USB hub or to a different Metrohm control instrument.

You need administrator rights for the installation of driver software and control software on your computer.

**Cable connection and driver installation**

A driver installation is required in order to ensure that the 905 Titrande is recognized by the computer software. To accomplish this, you must comply with the procedures specified. The following steps are necessary:

**1 Install the software**

- Insert the computer software installation CD and carry out the installation program directions.
- Exit the program if you have started it after the installation.

**2 Establishing the cable connections**

- Connect all peripheral devices to the instrument, *see chapter 3.3, page 15*.
- Connect the instrument to the power grid if you have not already done this (*see chapter 3.2.1.2, page 12*).  
The "On" LED on the 905 Titrande is not yet illuminated!
- Connect the instrument to a USB connector (type A) of your computer (see manual of your computer). The 6.2151.000 cable is used for this purpose.

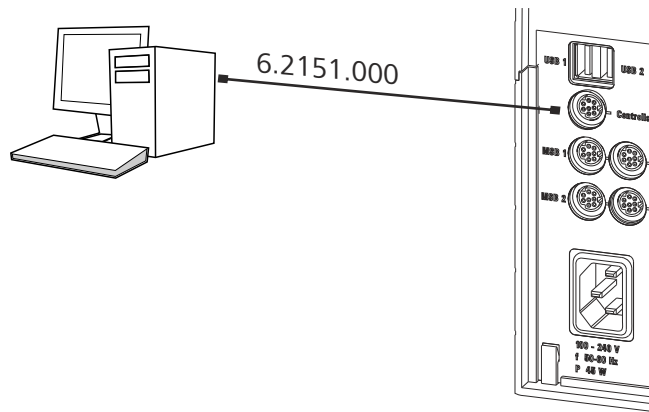

Figure 5 Connecting the computer

The instrument is recognized. Depending on the version of the Windows operating system used, the driver installation proceeds differently afterwards. Either the necessary driver software is installed automatically or an installation wizard is started.

- 3 Follow the instructions of the installation wizard.

The "On" LED on the 905 Titrande lights up when the driver installation has been completed and the instrument is ready for operation.

If problems should occur during installation, contact your company's IT support team.



**NOTICE**

The plug on the instrument end of the 6.2151.000 controller cable is protected against accidental disconnection by means of a pull-out protection feature. If you wish to pull out the plug, you first need to pull back the outer plug sleeve marked with arrows.

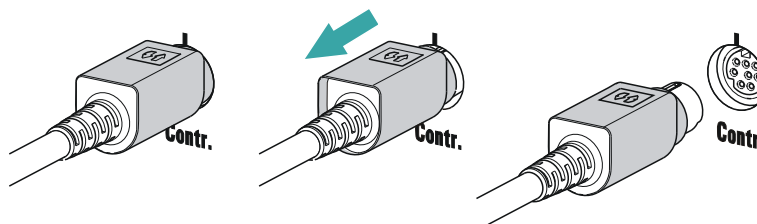

**Registering and configuring the instrument in the computer software**

The instrument must be registered in the configuration of your computer software. Once that has been done, you can then configure it according to your requirements. Proceed as follows:

## 1 Setting up the instrument

- Start the computer software.  
The instrument is automatically recognized. The configuration dialog for the instrument is displayed.
- Make configuration settings for the instrument and its connectors.

More detailed information concerning the configuration of the instrument can be found in the documentation for the respective computer software.

## 3.3 Connecting MSB devices

In order to connect MSB devices, e.g. stirrers or dosing devices, Metrohm instruments are equipped with up to a maximum of four connectors on what is referred to as the *Metrohm Serial Bus* (MSB). Various kinds of peripheral devices can be connected in sequence (in series, as a "Daisy Chain") at a single MSB connector (8-pin Mini DIN socket) and controlled simultaneously by the respective control instrument. In addition to the connection cable, stirrers and the Remote Box are each equipped with their own MSB socket for this purpose.

The following figure provides an overview of the instruments that can be connected to an MSB socket, along with a number of different cabling variations.

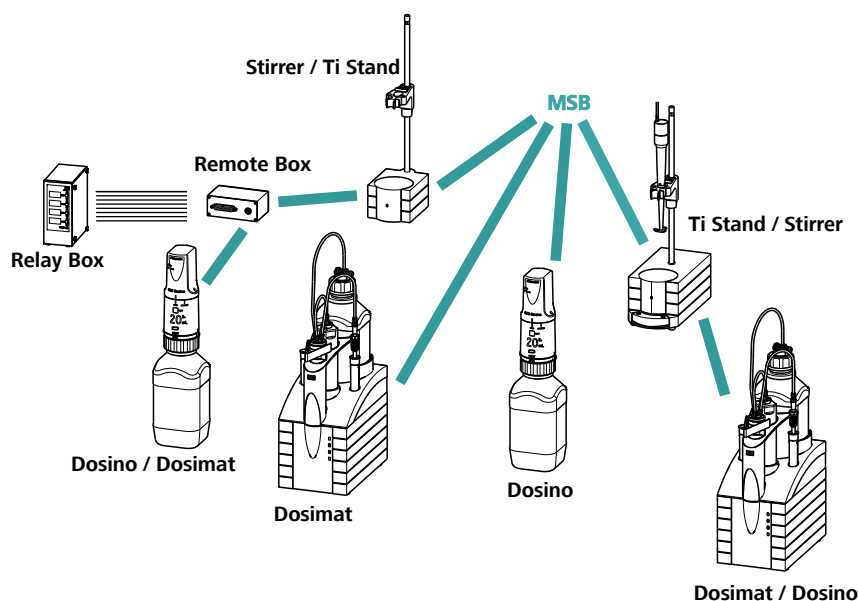

Figure 6 MSB connections

The control instrument determines which peripheral devices are supported.



#### NOTICE

When connecting MSB devices together, the following must be observed:

- Only one device of the same type can be used at a single MSB connector at one time.
- Dosing devices of the 700 Dosino and 685 Dosimat plus type cannot be connected together with other MSB devices on a shared connector. These dosing devices must be connected separately.



#### CAUTION

Exit the control software before you plug in MSB devices. When it is switched on, the control instrument automatically recognizes which device is connected to which MSB connector. The operating unit or the control software enters the connected MSB devices into the system configuration (device manager).

MSB connections can be extended with the 6.2151.010 cable. The maximum connection length permitted is 15 m.

### 3.3.1 Connecting a dosing device

Four dosing devices can be connected to the instrument (**MSB 1 to MSB 4**).

The types of dosing devices that are supported are:

- 800 Dosino
- 700 Dosino
- 805 Dosimat
- 685 Dosimat plus

Proceed as follows:

#### 1 Connecting a dosing device

- Exit the control software.
- Connect the connection cable of the dosing device to one of the sockets marked with **MSB** on the rear of the control device.
- Start the control software.



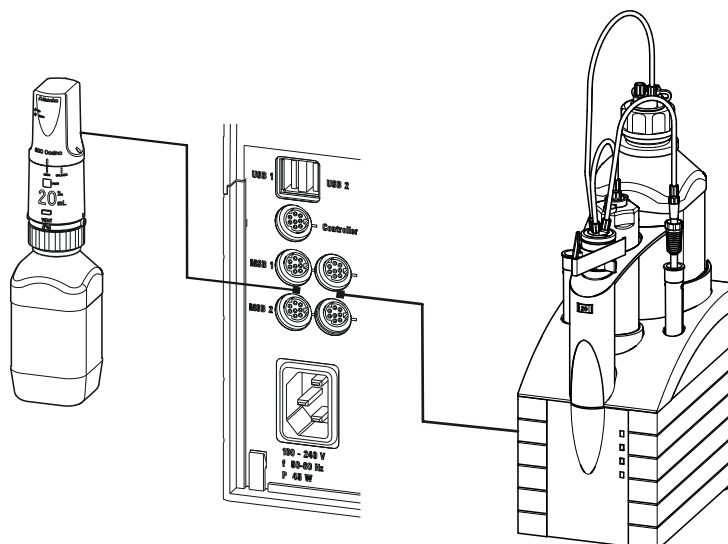

Figure 7 Connecting a dosing device

### 3.3.2 Connecting a stirrer or titration stand

You can use the following instruments:

These devices have a built-in magnetic stirrer (stirring "from below"):

- 801 Stirrer
- 803 Ti Stand

This device has no built-in magnetic stirrer (stirring "from above"):

- 804 Ti Stand with rod stirrer 802 Stirrer

Connect a stirrer or a titration stand as follows:

#### 1 Connecting the stirrer or titration stand

- Exit the control software.
- Connect the connection cable of the magnetic stirrer or of the titration stand to one of the sockets marked with **MSB** on the rear of the control instrument.
- 804 Ti Stand only: Connect the rod stirrer to the stirrer connector (socket with stirrer symbol) of the titration stand.
- Start the control software.

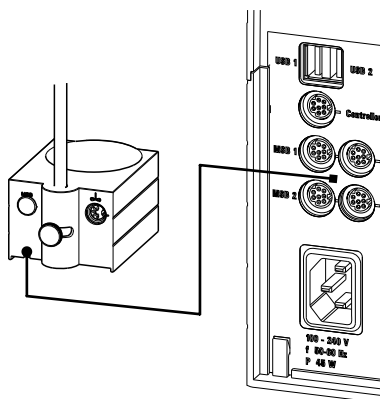

Figure 8 Connecting an MSB stirrer

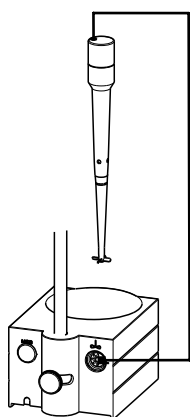

Figure 9 Connecting the rod stirrer to the titration stand

### 3.3.3 Connecting a Remote Box

Instruments that are controlled via remote lines and/or that send control signals via remote lines can be connected via the 6.2148.010 Remote Box. In addition to Metrohm, other instrument manufacturers also use similar connectors that make it possible to connect different instruments together. These interfaces are also frequently given the designations "TTL Logic", "I/O Control" or "Relay Control" and they generally have a signal level of 5 volts.

Control signals are understood to be electrical line statuses or electrical pulses ( $> 200$  ms) which display the operating status of an instrument or which trigger or report an event. Sequences on a variety of instruments can thus be coordinated in a single complex automation system. However, no exchange of data is possible.

Proceed as follows:

#### 1 Connecting the Remote Box

- Exit the control software.

- Connect the Remote Box connection cable to one of the sockets marked with **MSB** on the rear of the control instrument.
- Start the control software.

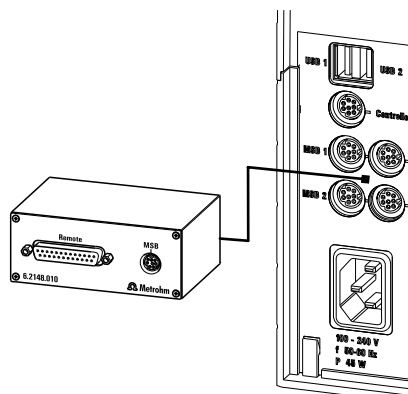

Figure 10 Connecting the Remote Box

You can connect the following instruments to the remote connector, among others:

- 849 Level Control (fill level monitoring in a canister)
- 731 Relay Box (switch box for 230/110 volt alternating current sockets and low-voltage direct current outlets)
- 843 Pump Station (for complex sample preparations or for rinsing external titration vessels)

The Remote Box also has an MSB socket at which a further MSB device, e.g. a dosing device or a stirrer, can be connected.

You will find precise information concerning the pin assignment of the interface on the Remote Box in the *appendix*.

## 3.4 Connecting USB devices

### 3.4.1 General

The 905 Titrande has two USB connectors (type A sockets) for peripheral devices with USB interfaces. The Titrande functions as a USB hub (distributor) no matter how it is operated. If you wish to connect more than two devices to the USB, you can also use an additional, commercially available USB hub.

**CAUTION**

If you operate the 905 Titrando with the aid of the Touch Control, take care to ensure that the Touch Control is switched off when you set up or disconnect connections between the various instruments. If you use a PC software to control the 905 Titrando, you should exit the program before you set up or disconnect the USB connections.

**3.4.2 Connecting a USB hub**

If you wish to connect more than two devices to the USB connector of the 905 Titrando, you can also use an additional commercially available USB hub (distributor). If you operate the 905 Titrando with the help of the Touch Control, then you should use a USB hub with its own power supply.

Connect the USB hub as follows:

- 1** Switch off the Touch Control and/or exit the PC software.
- 2** With the aid of the 6.2151.020 cable, connect the USB connector of the 905 Titrando (type A) with the USB connector of the hub (type B, see manual for the hub).
- 3** Switch on the Touch Control.

The USB hub is recognized automatically.

**3.4.3 Connecting a printer**

Printers that are connected to the 905 Titrando with Touch Control must meet the following requirements:

- Printer languages: HP-PCL (PCL 3 to 5, PCL 3GUI), Canon BJJ Commands or Epson ESC P/2
- Printer resolution: 300 dots/inch or 360 dots/inch (Epson)
- Paper size: A4 or Letter, single-sheet feed.

Connect the printer as follows:

- 1** Switch off the Touch Control.
- 2** With the aid of the 6.2151.020 cable, connect the USB connector of the 905 Titrando (type A) with the USB connector of the printer (type B, see manual for the printer).
- 3** Switch on the printer first, then the Touch Control.

- 4** Configure the printer in the device manager of the Touch Control (see Touch Control manual).

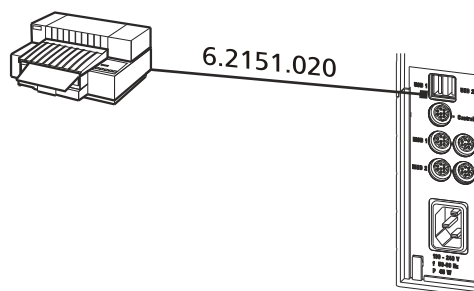

Figure 11 Connecting a printer

### 3.4.4 Connecting a balance

- Operation with a PC software:
  - Connect the balance directly to the serial connector (COM) of the computer. This is usually 9-pin and marked with the symbol **IOIOI**.
- Operation with Touch Control:
  - You will need the 6.2148.050 USB/RS-232 adapter to connect a balance.

The following table offers an overview of the balances that you can use together with the 905 Titrando and of which cable you will need for connection to the RS-232 interface:

Balance	Cable
AND ER, FR, FX with RS-232 interface (OP-03)	6.2125.020 + 6.2125.010
Mettler AB, AG, PR (LC-RS9)	In the scope of delivery for the balance
Mettler AM, PM, PE with interface option 016 or Mettler AJ, PJ with interface option 018	6.2146.020 + 6.2125.010  Also from Mettler: ME 47473 adapter and either ME 42500 hand switch or ME 46278 foot switch
Mettler AT	6.2146.020 + 6.2125.010  Also from Mettler: ME 42500 hand switch or ME 46278 foot switch
Mettler AX, MX, UMX, PG, AB-S, PB-S, XP, XS	6.2134.120



Balance	Cable
Mettler AE with interface option 011 or 012	6.2125.020 + 6.2125.010 Also from Mettler: ME 42500 hand switch or ME 46278 foot switch
Ohaus Voyager, Explorer, Analytical Plus	Cable AS017-09 from Ohaus
Precisa balances with RS-232-C interface	6.2125.080 + 6.2125.010
Sartorius MP8, MC, LA, Genius, Cubis	6.2134.060
Shimadzu BX, BW	6.2125.080 + 6.2125.010

### Operation with Touch Control

Connect the balance as follows:

- 1 Plug in the USB plug of the USB/RS-232 adapter at the USB connector of the 905 Titrande.
- 2 Connect the RS-232 interface of the USB/RS-232 adapter with the RS-232 interface of the balance (see table for cable).
- 3 Switch on the Touch Control.
- 4 Switch on the balance.
- 5 Activate the RS-232 interface of the balance if necessary.
- 6 Configure the RS-232 interface of the USB/RS-232 adapter in the device manager of the Touch Control (see Touch Control manual).

#### 3.4.5 Connecting a PC keyboard (only for operation with Touch Control)

The PC keyboard is used as an aid for text and numerical input.

Connect the PC keyboard as follows:

- 1 Insert the USB plug of the keyboard into one of the USB sockets of the 905 Titrande.

- 2 Switch on the Touch Control.

The keyboard is recognized automatically and entered in the device manager.

- 3 Configure the keyboard in the device manager of the Touch Control (see Touch Control manual).

### 3.4.6 Connecting a barcode reader

The barcode reader is used as an aid for text and numerical input. You can connect a barcode reader with USB interface.

#### Operation with Touch Control

Connect the barcode reader as follows:

- 1 Insert the USB plug of the barcode reader into one of the USB sockets of the 905 Titrandò.
- 2 Switch on the Touch Control.  
The barcode reader is recognized automatically and entered in the device manager.
- 3 Configure the barcode reader in the device manager of the Touch Control (see Touch Control manual).

#### Settings on the barcode reader:

Program the barcode reader as follows (see also the manual for the barcode reader):

- 1 Switch the barcode reader to programming mode.
- 2 Specify the desired layout for the keyboard (USA, Germany, France, Spain, German-speaking Switzerland).  
This setting must match the setting in the device manager (see the Touch Control manual).
- 3 Make sure that the barcode reader is set in such a way that Ctrl characters (ASCII 00 to 31) can be sent.



- 4 Program the barcode reader in such a way that the ASCII character 02 (STX or Ctrl B) is sent as the first character. This first character is normally referred to as the "Preamble" or "Prefix Code".
- 5 Program the barcode reader in such a way that the ASCII character 04 (EOT or Ctrl D) is sent as the last character. This last character is normally referred to as the "Postamble", "Record Suffix" or "Postfix Code".
- 6 Exit the programming mode.

## 3.5 Connecting sensors

The measuring interface contains the following measuring inputs:

- **Ind.** for a potentiometric electrode (pH, metal or ion-selective electrode)
- **Ref.** for a separate reference electrode
- **Temp.** for a temperature sensor (Pt1000 or NTC)
- **Pol.** for a polarizable electrode
- **iConnect** for an iConnect (measuring interface for electrodes with integrated data chip, so-called iTrodes)

### 3.5.1 Connecting a pH, metal or ion-selective electrode

Connect the pH, metal or ion-selective electrode as follows:

- 1 Plug the electrode plug into the **Ind.** socket of the 905 Titrand.

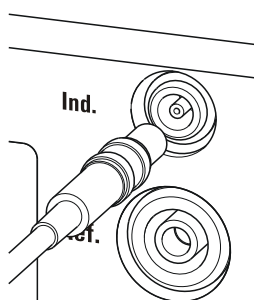

Figure 12 Connecting a pH, metal or ion-selective electrode



**NOTICE**

The electrode cable is protected against accidental disconnection of the cable by means of a pull-out protection. If you wish to pull out the plug again, you first need to pull back the outer plug sleeve.

### 3.5.2 Connecting a reference electrode

Connect the reference electrode as follows:

- 1 Plug the electrode plug into the **Ref.** socket of the 905 Titrande.

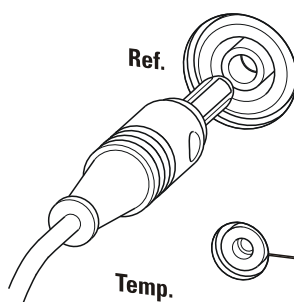

Figure 13 Connecting a reference electrode

### 3.5.3 Connecting a polarizable electrode

Connect the polarizable electrode as follows:

- 1 Plug the electrode plug into the **Pol.** socket of the 905 Titrande.

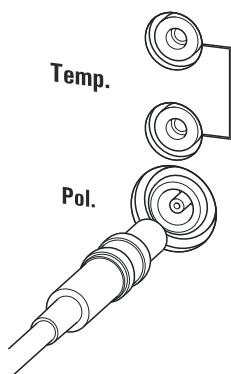

Figure 14 Connecting a polarizable electrode



#### NOTICE

The electrode cable is protected against accidental disconnection of the cable by means of a pull-out protection. If you wish to pull out the plug again, you first need to pull back the outer plug sleeve.

### 3.5.4 Connecting a temperature sensor or an electrode with integrated temperature sensor

A temperature sensor of the Pt1000 or NTC type can be connected to the **Temp.** connector.

Connect the temperature sensor or the electrode with integrated temperature sensor as follows:

- 1 Insert the plugs of the temperature sensor into the **Temp.** sockets of the Titrande.

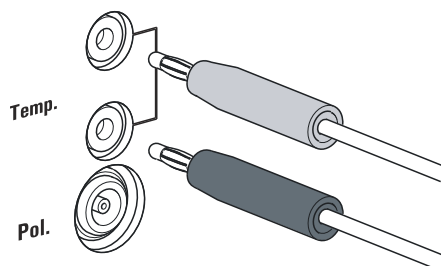

Figure 15 Connecting a temperature sensor or an electrode with integrated temperature sensor



#### NOTICE

Always insert the red plug into the red socket. This is the only way that shielding against electrical interference can be ensured.

### 3.5.5 Connecting the iConnect

The external measuring interface 854 iConnect can be connected to the **iConnect** connector.

### Connecting the 6.2168.000 mini USB adapter cable to an instrument

If the mini USB adapter cable is not connected to the instrument yet, proceed as follows:

- 1 Plug the mini USB adapter cable (2) into the **iConnect** connector of the instrument (1). Observe the correct orientation (markings).

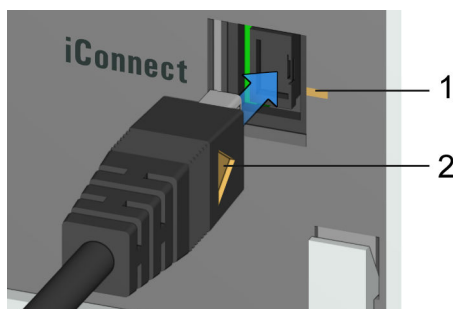

Figure 16 Plugging in the mini USB adapter cable

Depending on the instrument's model version, there may be several **iConnect** connectors.

- 2 Leave the adapter cable plugged in to protect the connector inside the instrument (1) against mechanical impact.

### Connecting the 854 iConnect to the adapter cable

Make sure that the mini USB adapter cable is connected to the instrument.

The 854 iConnect can also be connected while the instrument is switched on.

- 1 Plug the plug of the 854 iConnect (3) into the socket of the mini USB adapter cable (2). Observe the correct orientation (markings).

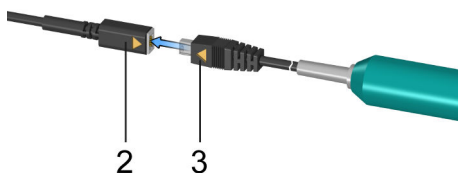

Figure 17 Plugging in the 854 iConnect

As soon as the instrument is switched on, the 854 iConnect is detected automatically and entered as measuring input into the device properties.

### Connecting the electrode

The 854 iConnect is used as measuring input for iTrodes (electrodes with integrated memory chip).

Connect the electrode as follows:

- 1 Remove the protective cap of the 854 iConnect.

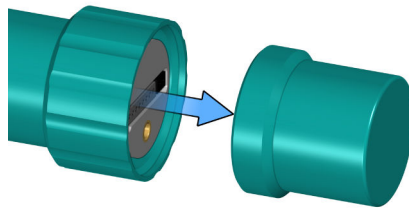

Figure 18 Removing the protective cap

- 2 Align the guide pin (5) of the electrode with the recess in the 854 iConnect (4).

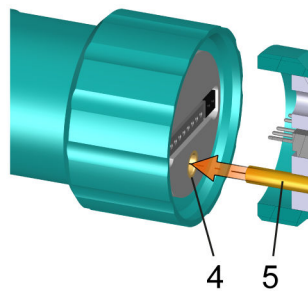

Figure 19 Aligning the guide pin

- 3 Attach the electrode to the 854 iConnect.

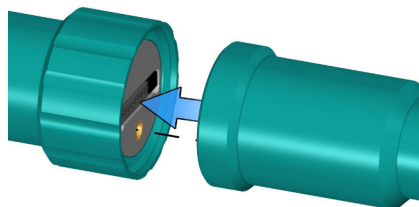

Figure 20 Attaching the electrode

The guide pin guarantees correct connection in such a way that the contact pins cannot be damaged.

- 4 Tighten the screw cap by hand.

If there is an electrode in the sensor list of the firmware or software, the electrode is detected automatically when connecting it.



#### NOTICE

Mount the protective cap again as soon as the 854 iConnect is not in use anymore and no electrode is connected.

### Removing the 854 iConnect

The 854 iConnect can also be removed while the instrument is switched on.

- 1 Unplug the 854 iConnect (3) from the socket of the mini USB adapter cable (2).

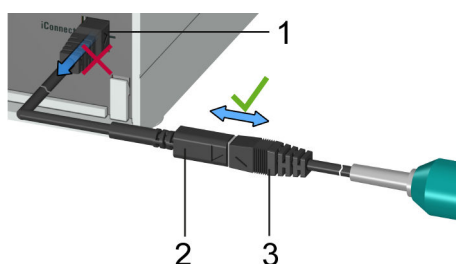

Figure 21 Unplugging the 854 iConnect

- 2 Leave the mini USB adapter cable (2) plugged into the socket of the instrument (1).



#### NOTICE

Position the mini USB adapter cable in such a way that it cannot be removed by accident.



#### NOTICE

For further information on the 854 iConnect, see *Manual iConnect 854*, article number 8.854.8002.



### 3.5.6 Differential potentiometry

Potentiometric measurements with high-ohm measuring chains can be disrupted by electrostatic and electromagnetic fields in media with low conductivity. Use our 6.0229.100 Solvotrode or other special electrodes for pH measurements in organic solvents. If no reliable measurements are possible with these, then a 6.5104.030 (230 V) or 6.5104.040 (115 V) differential amplifier can be used. The differential amplifier is connected to the high-ohm measuring input (**Ind.**).

## 4 Setting up the titration vessel

### 4.1 General

During the titration, it is important that the solution be well-mixed. The stirring rate should be high enough for a small "vortex" to appear. If the stirring rate is too high, then air bubbles will be aspirated. This results in incorrect measured values. If the stirring rate is too low, then the solution at the electrode will not be correctly mixed. In order to ensure that measurement is carried out in a well-mixed solution following addition of the titrant, the buret tip should be placed in a position where the turbulence is high. In addition, the distance between the addition of the titrant and the electrode should be as large as possible. Also take into account the stirring direction (counterclockwise or clockwise) when positioning electrode and buret tip (see figure below).

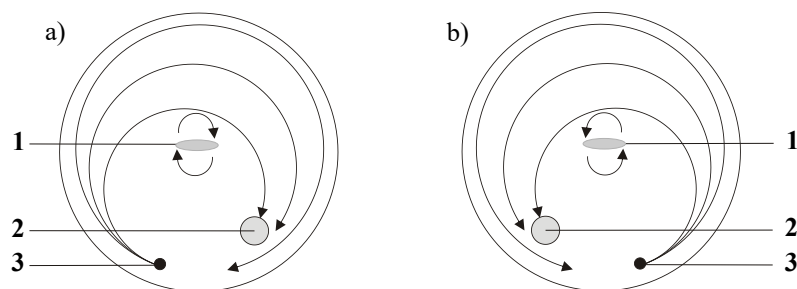

Figure 22 Schematic configuration of magnetic stirrer, electrode and buret tip during a titration. a) stirring direction clockwise, b) stirring direction counterclockwise.

**1** Magnetic stirrer

**2** Electrode

**3** Buret tip





## 6 Troubleshooting

### 6.1 General

Problem	Cause	Remedy
The "On" LED is not illuminated, even though the instrument is connected to the power supply.	<i>The Touch Control or the computer has not been switched on yet or the plugs are not correctly plugged in.</i>	<ol style="list-style-type: none"> <li>1. Check the plug connections.</li> <li>2. Switch on the Touch Control or the computer.</li> </ol>

### 6.2 SET titration

Problem	Cause	Remedy
The titration will not be finished.	<i>The minimum dosing rate is too low.</i>	Select the user-defined titration rate and increase the minimum rate (see manual/help of the software used).
	<i>The stop criterion is unsuitable.</i>	Adjust the control parameters (see manual/help of the software used): <ul style="list-style-type: none"> <li>▪ Increase the stop drift.</li> <li>▪ Select a short delay time.</li> </ul>
The sample is over-titrated.	<i>The control parameters are unsuitable.</i>	Adjust the control parameters (see manual/help of the software used): <ul style="list-style-type: none"> <li>▪ Select Titration rate = <b>slow</b>.</li> <li>▪ Select the user-defined titration rate and increase the control range.</li> <li>▪ Select the user-defined titration rate and reduce the maximum rate.</li> <li>▪ Select the user-defined titration rate and reduce the minimum rate.</li> <li>▪ Stir faster.</li> <li>▪ Arrange the electrode and buret tip to an optimum.</li> </ul>
	<i>The electrode responds too slowly.</i>	Replace the electrode.
The titration time is too long.	<i>The control parameters are unsuitable.</i>	Adjust the control parameters (see manual/help of the software used): <ul style="list-style-type: none"> <li>▪ Select Titration rate = <b>optimal</b> or <b>fast</b>.</li> </ul>



Problem	Cause	Remedy
		<ul style="list-style-type: none"> <li>▪ Select the user-defined titration rate and decrease the control range.</li> <li>▪ Select the user-defined titration rate and increase the maximum rate.</li> <li>▪ Select the user-defined titration rate and increase the minimum rate.</li> </ul>
<b>The results are spread widely.</b>	<i>The minimum dosing rate is too high.</i>	Select user-defined titration rate and decrease the minimum rate (see manual/help of the software used).
	<i>The electrode responds too slowly.</i>	Replace the electrode.

## 7 Appendix

### 7.1 Remote interface

The 6.2148.010 Remote Box allows devices to be controlled which cannot be connected directly to the MSB interface of the Titrando.

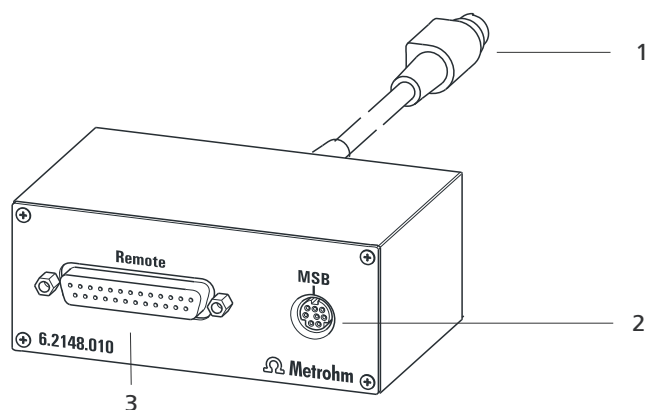

Figure 23 Connectors of the Remote Box

#### 1 Cable

For connecting to the Titrando.

#### 2 MSB connector

Metrohm Serial Bus. For connecting external dosing devices or stirrers.

#### 3 Remote connector

For connecting instruments with a remote interface.

#### 7.1.1 Pin assignment of the remote interface

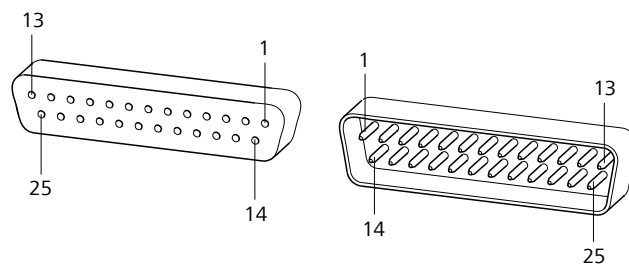
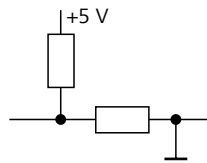

Figure 24 Pin assignment of remote socket and remote plug

The above figure of the pin assignment applies for all Metrohm instruments with 25-pin D-Sub remote connector.

### Inputs



approx. 50 k $\Omega$  Pull-up

$t_p > 20$  ms

active = low, inactive = high

### Outputs

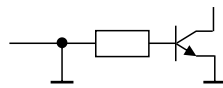

Open Collector

$t_p > 200$  ms

active = low, inactive = high

$I_C = 20$  mA,  $V_{CE0} = 40$  V

+5 V: maximum load = 20 mA

The following tables offer information concerning the assignment of the individual pins and their function:

Table 1 Inputs and outputs of the remote interface

Assignment	Pin No.	Function*
Input 0	21	<b>Start</b>
Input 1	9	<b>Stop</b>
Input 2	22	
Input 3	10	<b>Quit</b>
Input 4	23	–
Input 5	11	
Input 6	24	
Input 7	12	
Output 0	5	<b>Ready</b>
Output 1	18	<b>Conditioning OK</b>
Output 2	4	<b>Determination</b>
Output 3	17	<b>EOD</b>
Output 4	3	
Output 5	16	<b>Error</b>
Output 6	1	
Output 7	2	<b>Warning</b>

Assignment	Pin No.	Function*
Output 8	6	
Output 9	7	
Output 10	8	
Output 11	13	
Output 12	19	
Output 13	20	
0 volts / GND	14	
+5 volts	15	
0 volts / GND	25	

\* Signal activated only for operation with Touch Control.

Table 2 Explanation of the individual functions

Function	Explanation
<b>Start</b>	The current method is started at the time of activation. $t_{\text{pulse}} > 100 \text{ ms}$
<b>Stop</b>	The current method is canceled (Stop) at the time of activation. $t_{\text{pulse}} > 100 \text{ ms}$
<b>Quit</b>	The current command in the determination run will be canceled at the time of activation. $t_{\text{pulse}} > 100 \text{ ms}$
<b>Ready</b>	The instrument is ready to receive a start signal.
<b>Conditioning OK</b>	The line is set when Conditioning with SET titration and KFT titration is at OK. The line remains set until the determination is started with <b>[START]</b> .
<b>Determination</b>	The instrument performs a data-generating determination.
<b>EOD</b>	<b>End of Determination.</b> Pulse ( $t_{\text{pulse}} = 200 \text{ ms}$ ) after a determination or after a buffer/standard solution during calibration using a Sample Processor.
<b>Error</b>	The line is set for error message display.



Function	Explanation
<b>Warning</b>	The line is set for warning message display.

## 8 Technical specifications

### 8.1 Measuring interface

Depending on the version, the 905 Titrande has one (version 2.905.xx10) or two (version 2.905.xx20) galvanically isolated measuring interface(s).

The measuring cycle is 100 ms for all measuring modes.

#### 8.1.1 Potentiometry

One high-ohm measuring input (**Ind.**) for pH, metal or ion-selective electrodes and one measuring input (**Ref.**) for separate reference electrodes.

*Input resistance*  $> 1 \cdot 10^{12} \Omega$

*Offset current*  $< 1 \cdot 10^{-12} \text{ A}$  (under reference conditions)

*Measuring mode*  
pH

*Measuring range* -13 to +20 pH

*Resolution* 0.001 pH

*Measuring accuracy*  $\pm 0.003 \text{ pH}$   
( $\pm 1$  digit, without sensor error, under reference conditions)

*Measuring mode*  
U

*Measuring range* -1,200 to +1,200 mV

*Resolution* 0.1 mV

*Measuring accuracy*  $\pm 0.2 \text{ mV}$   
( $\pm 1$  digit, without sensor error, under reference conditions)

#### 8.1.2 Temperature

A measuring input (**Temp.**) for temperature sensors of the Pt1000 or NTC type with automatic temperature compensation.

R (25 °C) and B value can be configured for NTC sensors.

*Measuring range*

*Pt1000* -150 to +250 °C

*NTC* -5 to +250 °C

(R (25 °C) = 30,000  $\Omega$  and B (25/50) = 4,100 K)

*Resolution*

<i>Pt1000</i>	0.1 °C
<i>NTC</i>	0.1 °C

*Measuring accuracy*

<i>Pt1000</i>	±0.2 °C (Applies for measuring range –20 to +150 °C; ±1 digit; without sensor error, under reference conditions)
<i>NTC</i>	±0.6 °C (Applies for measuring range +10 to +40 °C; ±1 digit; without sensor error, under reference conditions)

**8.1.3 Polarizer**

One measuring input (**Pol.**) for polarizable electrodes.

*Measuring mode  
I<sub>pol</sub>*

Determination with adjustable polarization current

<i>Polarization current</i>	–122.5 to +122.5 µA (increment: 0.5 µA) –125.0 to +125.0 µA: non-guaranteed values, dependent on reference voltage +2.5 V
-----------------------------	--

<i>Measuring range</i>	–1,200 to +1,200 mV
------------------------	---------------------

<i>Resolution</i>	0.1 mV
-------------------	--------

<i>Measuring accuracy</i>	±0.2 mV (±1 digit, without sensor error, under reference conditions)
---------------------------	---

*Measuring mode  
U<sub>pol</sub>*

Determination with adjustable polarization voltage

<i>Polarization voltage</i>	–1,225 to +1,225 mV (increment: 25 mV) –1,250 to +1,250 mV: non-guaranteed values, dependent on reference voltage +2.5 V
-----------------------------	---

<i>Measuring range</i>	–120 to +120 µA
------------------------	-----------------

<i>Resolution</i>	0.1 µA
-------------------	--------



## 8.2 Power connection

<i>Supply voltage</i>	100 to 240 V
<i>Frequency</i>	50–60 Hz
<i>Power consumption</i>	Maximum 45 W
<i>Fuse</i>	Electronic overload protection

## 8.3 Ambient temperature

<i>Nominal function range</i>	+5 to +45 °C at max. 80% relative humidity non-condensing
<i>Storage</i>	+5 to +45 °C

## 8.4 Reference conditions

<i>Ambient temperature</i>	+25 °C (±3 °C)
<i>Relative humidity</i>	≤ 60%
<i>Instrument status</i>	Instrument in operation at least 30 min

## 8.5 Dimensions

<i>Width</i>	142 mm
<i>Height</i>	227 mm
<i>Depth</i>	231 mm
<i>Weight</i>	2.7 kg (version 2.905.xx10, without accessories) 2.8 kg (version 2.905.xx20, without accessories)
<i>Material (housing)</i>	Poly(butylene terephthalate) (PBT)



## 8.6 Interfaces

### USB connectors

*USB ports* 2 USB downstream ports (type A sockets), 500 mA each, for connecting peripheral devices such as printers, keyboards, barcode readers or RS-232/USB Box (Metrohm order no. 6.2148.020).

### "Controller" connector

*Controller port* USB upstream port with auxiliary power supply (Mini DIN socket) for connecting Touch Control or computer for controlling the 905 Titrande.

*Touch Control* With integrated Touch Control cable.

*Computer* With 6.2151.000 cable.

### MSB connectors (Metrohm Serial Bus)

*Dosing device* Connector for a maximum of 4 external dosing devices, models Dosi-mat or Dosino (MSB 1 to MSB 4).

*Stirrer* Connection of a maximum of 4 stirrers.  
Stirrer control: Switching on/off manually or coordinated with the titra-tion sequence.  
Speed in 15 steps and shift direction can be selected.

*Remote Box* Connection of a maximum of 4 Remote Boxes. Remote Boxes can be used to actuate and monitor external devices.

## 9 Accessories

Up-to-date information on the scope of delivery and optional accessories for your product can be found on the Internet. You can download this information using the article number as follows:

### Downloading the accessories list

- 1** Enter <https://www.metrohm.com/> into your Internet browser.
- 2** Enter the article number (e.g. **905**) into the search field.  
The search result is displayed.
- 3** Click on the product.  
Detailed information regarding the product is shown on various tabs.
- 4** On the **Included parts** tab, click on **Download the PDF**.  
The PDF file with the accessories data is created.



#### NOTICE

Once you have received your new product, we recommend downloading the accessories list from the Internet, printing it out and keeping it together with the manual for reference purposes.



# Index

- 6.2151.000 controller cable ..... 13
  - 685 Dosimat plus ..... 16
  - 700 Dosino ..... 16
  - 800 Dosino ..... 16
  - 801 Stirrer ..... 17
  - 803 Ti Stand ..... 17
  - 804 Ti Stand ..... 17
  - 805 Dosimat ..... 16
- A**
- ADD ..... 4
- B**
- Balance ..... 21
  - Barcode reader
    - Connect ..... 23
- C**
- Calibration mode
    - CAL ..... 4
  - Computer
    - Connect ..... 13
  - Connect
    - Balance ..... 21
    - Barcode reader ..... 23
    - Computer ..... 13
    - Dosing device ..... 16
    - MSB devices ..... 15
    - PC keyboard ..... 22
    - Power grid ..... 12
    - Printer ..... 20
    - Remote Box ..... 18
    - Stirrer ..... 17
    - Titration stand ..... 17
    - Touch Control ..... 11
    - USB hub ..... 20
  - Connector
    - MSB ..... 2
    - USB ..... 2
  - Controller
    - Connector ..... 9
- D**
- DET ..... 3
  - Device software
    - Update ..... 2
  - Differential potentiometry ..... 30
  - Dosing command ..... 3
    - ADD ..... 4
    - EMPTY ..... 4
  - LQH ..... 4
  - PREP ..... 4
  - Dosing device
    - Connect ..... 16
  - Driver software
    - Install ..... 13
- E**
- Electrode
    - Connect ..... 24
  - Electrode test
    - ELT ..... 4
  - Electrostatic charge ..... 7
  - EMPTY ..... 4
- I**
- Installation
    - Driver software ..... 13
  - Instrument description ..... 2
  - Instrument type ..... 9
- K**
- Keyboard
    - Connect ..... 22
- L**
- LED
    - On ..... 33
  - LQH ..... 4
- M**
- Maintenance ..... 32
  - MEAS ..... 4
  - Measuring interface ..... 2, 9
  - Measuring mode ..... 3
    - MEAS ..... 4
    - STDADD ..... 4
  - MET ..... 3
  - Metrohm Serial Bus MSB, see also "MSB" ..... 15
  - MSB
    - Connect devices ..... 15
    - Connector ..... 9
  - MSB connector ..... 2
- O**
- Overview of the instrument ..... 8
- P**
- PC keyboard
    - Connect ..... 22
  - Pin assignment ..... 35
  - Power connection ..... 9, 12, 13
  - PREP ..... 4
  - Printer ..... 20
- R**
- Remote
    - Interface ..... 35
    - Pin assignment ..... 35
  - Remote Box
    - Connect ..... 18
- S**
- Safety instructions ..... 6
  - Sensor
    - Connect ..... 24
  - Serial number ..... 9
  - Service ..... 6
  - SET ..... 3
  - STDADD ..... 4
  - Stirrer
    - Connect ..... 17
  - Stirring direction ..... 31
  - Supply voltage ..... 6
  - System test ..... 11
- T**
- Temperature sensor
    - Connect ..... 24
  - Titrand system ..... 1
  - Titration mode ..... 3
    - DET ..... 3
    - MET ..... 3
    - SET ..... 3
  - Titration stand
    - Connect ..... 17
  - Titration vessel
    - Equipping ..... 31
  - Touch Control
    - Connect ..... 11
- U**
- Update
    - Device software ..... 2
  - USB
    - Connector ..... 9
    - USB connector ..... 2



USB hub  
  Connect ..... 20