

Mass Spectrometry Fundamentals – Theory

BUILDING
BETTER SCIENCE

AGILENT AND YOU

Agilent Technologies is committed to the educational community and is willing to provide access to company-owned material.

This slide set was created by Agilent for teaching purposes only.

If you wish to use the pictures, sketches, or drawings for any other purpose, please contact Agilent first.

Introduction

Mass spectrometry (MS) is an analytical chemistry technique that helps identify the amount and type of chemicals present in a sample by measuring the mass-to-charge ratio and abundance of gas-phase ions.

A mass spectrum (plural *spectra*) is a plot of the ion signal as a function of the mass-to-charge ratio. From spectra, the mass of the molecular ion and fragments are used to determine the elemental composition or isotopic signature of a compound. This information is used to elucidate the chemical structures of molecules, such as pesticides or peptides.

Mass spectrometry works by ionizing chemical compounds to generate charged molecules or molecule fragments and measuring their mass-to-charge ratios.

Source: Wikipedia

Introduction

Nobel Prize Winning Technology

John Fenn and **Koichi Tanaka** won the Nobel Prize in Chemistry in 2002 for the development of two soft ionization technologies:

- Electrospray technology, Dr. Fenn
- Soft laser desorption, Dr. Tanaka

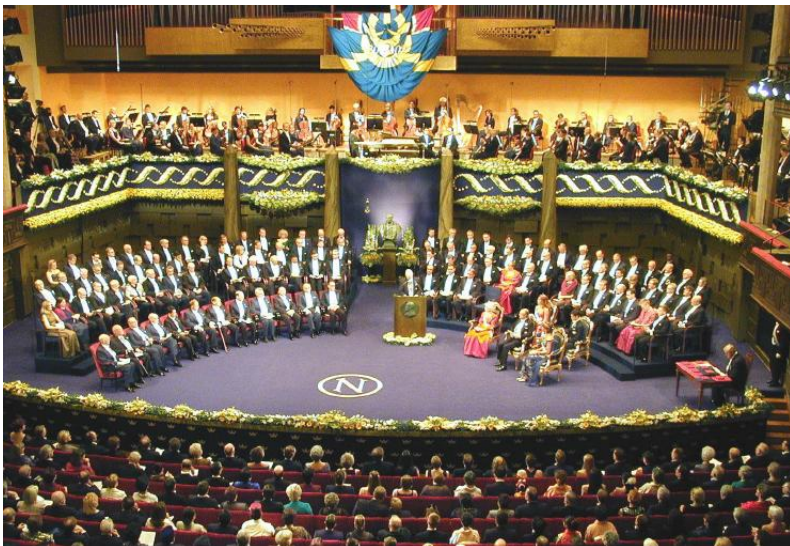

Concert Hall, Stockholm Sweden, Dec 2002



Dr. Fenn getting his Nobel Prize from the King of Sweden

Table of Contents (TOC)

Introduction

- [Basic Considerations](#)
- [Masses in Mass Spectrometry](#)
- [Fundamental Steps](#)

How It Works

- [Ionization](#)
 - [Electron Impact](#)
 - [Chemical Ionization](#)
 - [Sample Considerations \(LC-MS\)](#)
 - [Electrospray](#)
 - [Atmospheric Pressure Chemical Ionization](#)
 - [Atmospheric Pressure Photo Ionization](#)
 - [Multimode Ionization](#)
 - [MALDI](#)
 - [ICP](#)

How It Works

- [Mass Analyzer](#)
 - [Single Quadrupole](#)
 - [Triple Quadrupole](#)
 - [Ion Trap](#)
 - [Time-of-Flight](#)

Results

- [Mass Spectrum](#)
- [Single Quad vs. TOF](#)
- [Multiply Charged Ions and Deconvolution](#)

Further Information

- [Agilent Academia Webpage](#)
- [Publications](#)



Introduction

Basic Considerations

Elements can be uniquely identified by their mass. Mass Spectrometry is an analytical method to measure molecular or atomic weight.

Source: Periodic table, poster SI-0186

Compounds, consisting of different elements, can be distinguished by their mass:

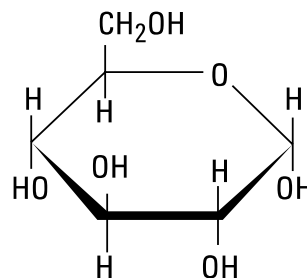

Glucose $C_6H_{12}O_6$
MW: 180,1559 g/mol

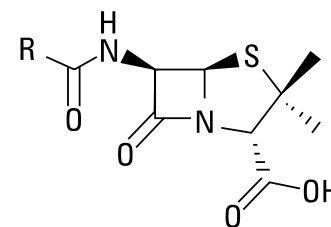

Penicillin $C_{16}H_{18}N_2O_4S$
MW: 334,39 g/mol

Introduction

Masses in Mass Spectrometry

The **average mass** of a molecule is obtained by summing the average atomic masses of the constituent elements.

Average mass of water (H₂O): $1.00794 + 1.00794 + 15.9994 = 18.01528$ Da

The **monoisotopic mass** is the sum of the masses of the atoms in a molecule using the unbound, ground-state, rest mass of the principal (most abundant) isotope for each element instead of the isotopic average mass. Monoisotopic mass is typically expressed in unified atomic mass units.

The **accurate mass** (more appropriately, the measured accurate mass) is an experimentally determined mass that allows the elemental composition to be determined. For molecules with mass below 200 u, 5 ppm accuracy is often sufficient to uniquely determine the elemental composition.

Introduction

Fundamental Steps

Typical MS procedure:

- Sample (solid, liquid, gas) is ionized
- Sample's molecules might break into charged fragments during ionization
- Ions are separated according to their mass-to-charge ratio (m/z)
- Ions are detected by a mechanism capable of detecting charged particles (e.g. electron multiplier)
- Results are displayed as spectra of the relative abundance as a function of m/z ratio
- Identification is done by correlating known masses to the identified masses or through a characteristic fragmentation pattern

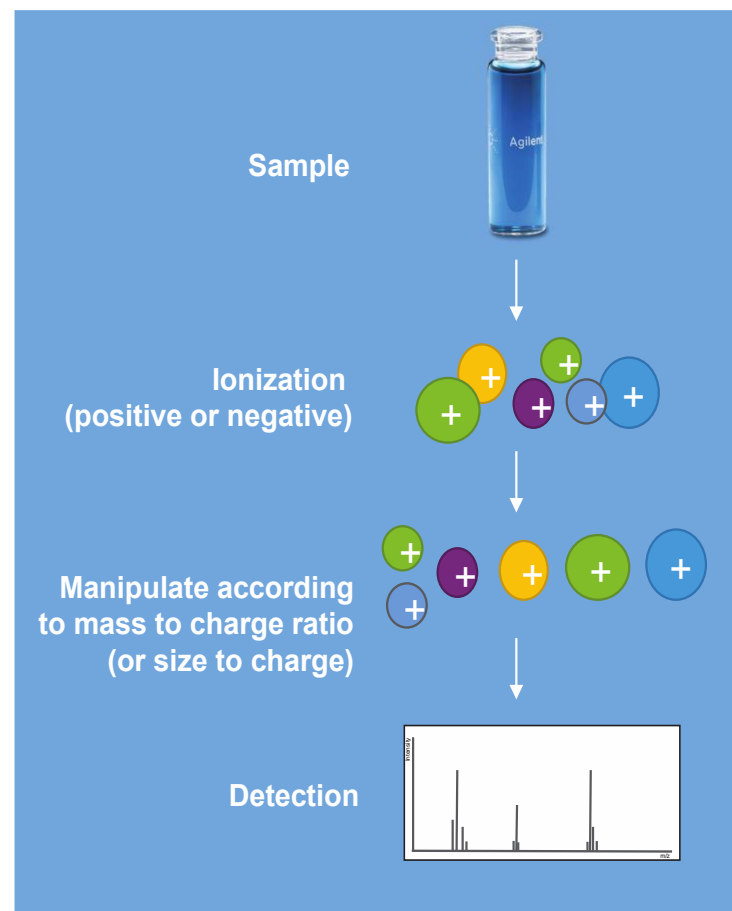

How It Works

Ionization

Before the sample can be mass analyzed, it must be ionized in the ion source.

Gaseous Sample Introduction:

- Electron Ionization (EI)
- Chemical Ionization (CI)

Liquid Sample Introduction:

- Electrospray Ionization (ESI)
- Atmospheric Pressure Chemical Ionization (APCI)
- Atmospheric Pressure Photo Ionization (APPI)
- Multimode Ionization (MMI)
- Matrix Assisted Laser Desorption Ionization (MALDI)
- Inductively Coupled Plasma (ICP)



How It Works

Ionization

Polarity of analytes determines the ionization source.

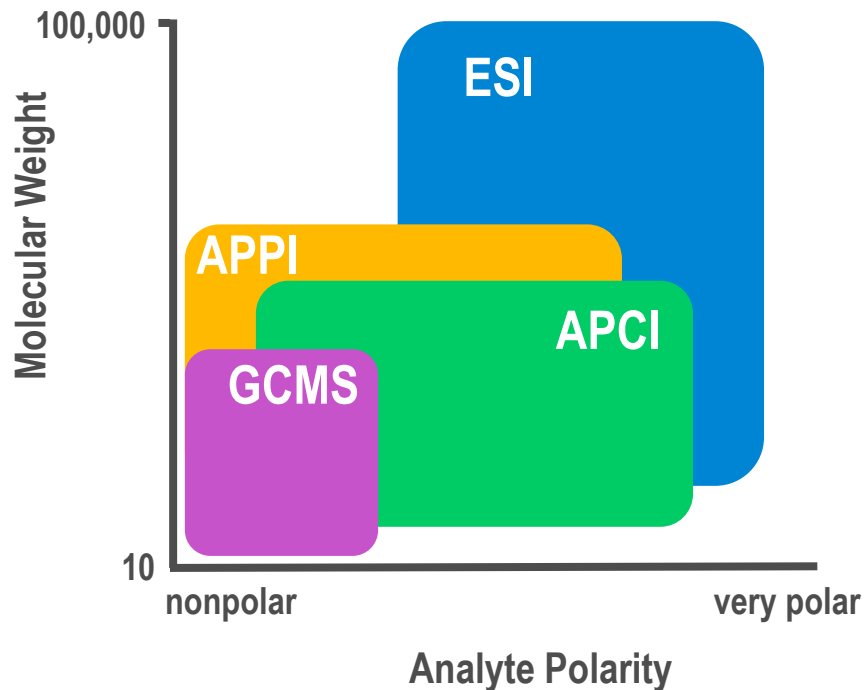

ESI	Electrospray ionization
APPI	Atmospheric pressure photo ionization
APCI	Atmospheric pressure chemical ionization
GC/MS	Gas chromatography / Mass spectrometry

How It Works

Ionization – Electron Impact (EI)

Electron Impact (EI) is well established, and is the most common method of ionization in Gas Chromatography (GC).

The molecules exiting the gas chromatograph are bombarded by an electron beam (70 eV) which removes an electron from the molecule resulting in a charged ion.

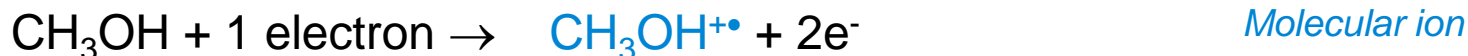

EI typically produces single charged molecular ions and fragment ions (smaller parts of the original molecules) which are used for structure elucidation.

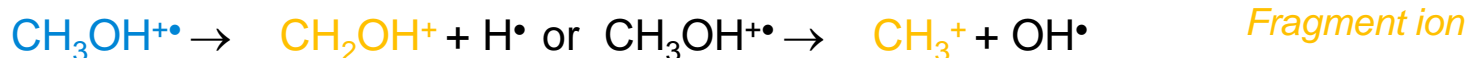

An electron or photomultiplier detects the separated ions.

The generated mass spectrum plots the signal intensity at a given m/z ratio.

How It Works

Ionization – Electron Impact (EI)

The GC/MS interface operates at high temperatures.

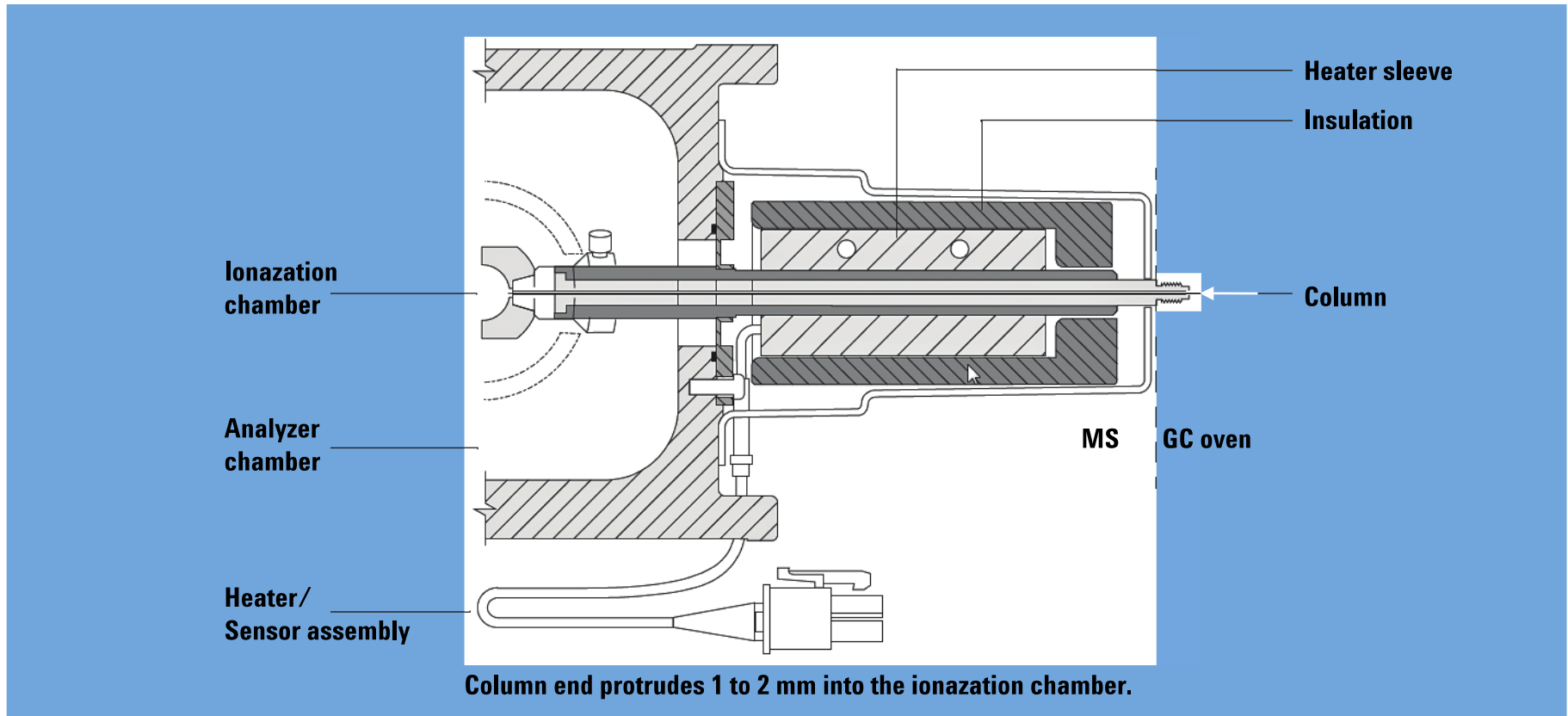

The EI GC/MS Interface. Source: [Agilent 7000 Series Triple Quad GC/MS Operation Manual](#) (p 46)

How It Works

Ionization – Chemical Ionization (CI)

EI is a direct energy transfer process with electron kinetic energy deposited directly into an analyte molecule.

CI is an indirect process involving an intermediate chemical agent. This is particularly true in positive chemical ionization (PCI). In PCI, the ion source is filled with a reagent gas which is ionized to create reagent ions which react with the analyte.

Most frequently used reagent gases: **methane**, **iso-butane** and **ammonia**.

The applied reagent gas determines the ionization and fragmentation behavior of the analyte.

The principal methane reactions are:

$\text{CH}_4 + \text{e}^- \rightarrow \text{CH}_4^+, \text{CH}_3^+, \text{CH}_2^+$ The reagent gas is ionized by electrons entering the ionization source.

$\text{CH}_4 + \text{CH}_4^+ \rightarrow \text{CH}_5^+, \text{CH}_3^\bullet$

$\text{CH}_2^+ + \text{CH}_4 \rightarrow \text{C}_2\text{H}_4^+ + \text{H}_2$

$\text{CH}_2^+ + \text{CH}_4 \rightarrow \text{C}_2\text{H}_3^+ + \text{H}_2^+\text{H}^\bullet$

$\text{CH}_3^+ + \text{CH}_4 \rightarrow \text{C}_2\text{H}_5^+ + \text{H}_2$

$\text{C}_2\text{H}_3^+ + \text{CH}_4 \rightarrow \text{C}_3\text{H}_5^+ + \text{H}_2$

How It Works

Ionization – Sample Considerations (LC/MS)

ESI



Volatility not required

Preferred technique for thermally labile analytes

Ions formed in solution

Can form multiply charged ions

APCI



Some volatility required

Analyte must be thermally stable

Ions formed in gas phase

Forms singly charged ions only

APPI



Some volatility required

Analyte must be thermally stable

Ions formed in gas phase

Forms singly charged ions only

Many compounds will ionize well using all three sources. APCI / APPI can ionize molecules that are too non-polar for ESI to ionize.



How It Works

Ionization – Sample Considerations (LC/MS)

ESI



- Ions in solution** e.g. catecholamine, sulfate conjugates, quaternary amines
- Compounds containing heteroatoms** e.g. carbamates, benzodiazepines
- Compounds that multiply charge in solution** e.g. proteins, peptides, oligonucleotides

APCI



- Compounds of intermediate MW and polarity** e.g. PAHs, PCBs, fatty acids, phthalates, alcohols
- Compounds containing heteroatoms** e.g. carbamates, benzodiazepines
- Compounds that are too non-polar for ESI response**

APPI



- Compounds of intermediate MW and intermediate to low polarity** e.g. PAHs, PCBs, fatty acids, phthalates, alcohols
- Compounds containing heteroatoms** e.g. carbamates, benzodiazepines
- Compounds that are too non-polar for ESI response**



How It Works

Ionization – Electrospray (ESI)

Electrospray ionization (ESI) is a soft ionization technique.

LC eluent is sprayed (nebulized) into a spray chamber at atmospheric pressure in the presence of a strong electrostatic field and heated drying gas. The electrostatic field occurs between the nebulizer, which is at ground in this design, and the capillary, which is at high voltage.

Suitable molecules:

- Small molecules (glucose) and large biomolecules (proteins, oligonucleotides)

Multiple charging is the phenomena in ESI that allows analysis of larger molecules (-> [Deconvolution](#))

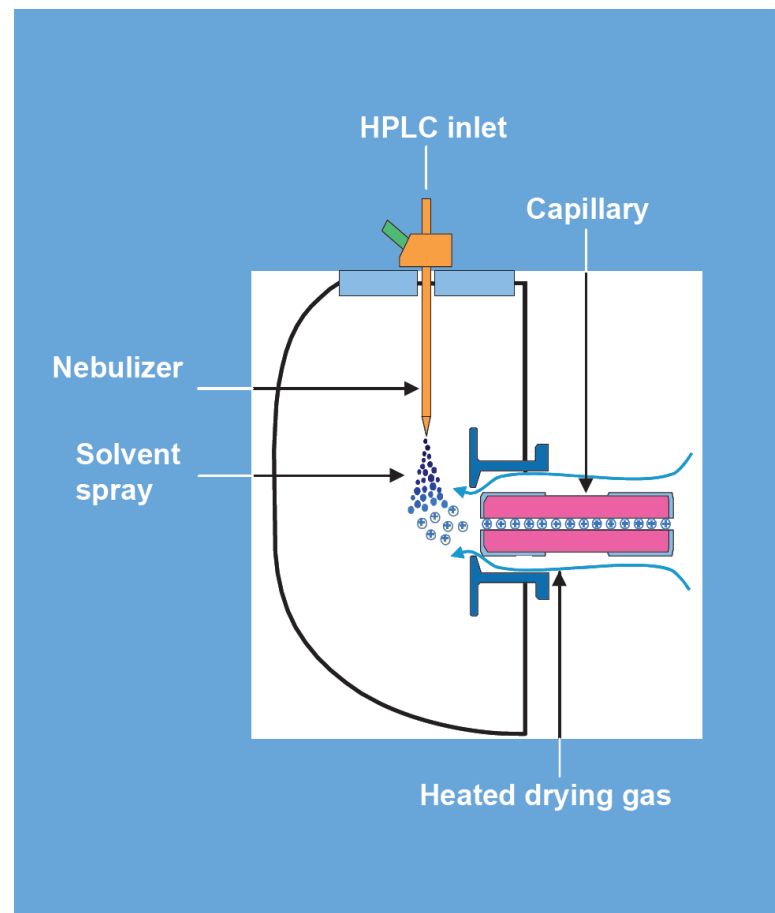

Electrospray ion source

Source: [LC/MS concept guides](#) (p 22)

How It Works

Ionization – ESI Process

From charged droplets to analyte ions

The nebulizer produces a uniform droplet size. The charged droplets are attracted toward the dielectric capillary. The heated nitrogen stream surrounding the capillary shrinks the droplets. This process is called **desolvation**.

The droplets continue to shrink until the repulsive electrostatic (Coulombic) forces exceed the droplet cohesive forces, leading to droplet explosions. This process is repeated until analyte ions are ultimately desorbed into the gas phase, driven by strong electric fields on the surface of the micro droplets. This process is called **ion evaporation**.

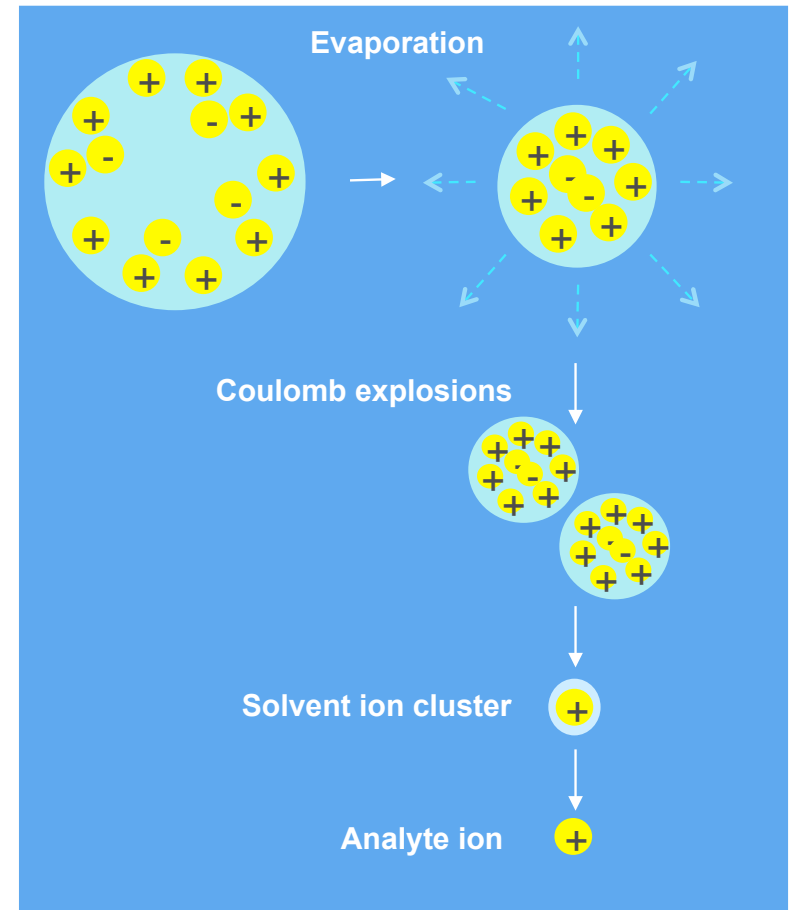

How It Works

Ionization – Atmospheric Pressure Chemical Ionization (APCI)

APCI is a gas-phase chemical ionization process. Therefore, the analyte needs to be in the gas phase for ionization.

LC eluent passes a nebulizing needle, which creates a fine spray.

The droplets are fully vaporized in a heated ceramic tube (~ 400 to 500°C).

Suitable molecules:

- Molecules < 1,500 u
- Less polar and non-polar compounds (typically analyzed by normal-phase chromatography)

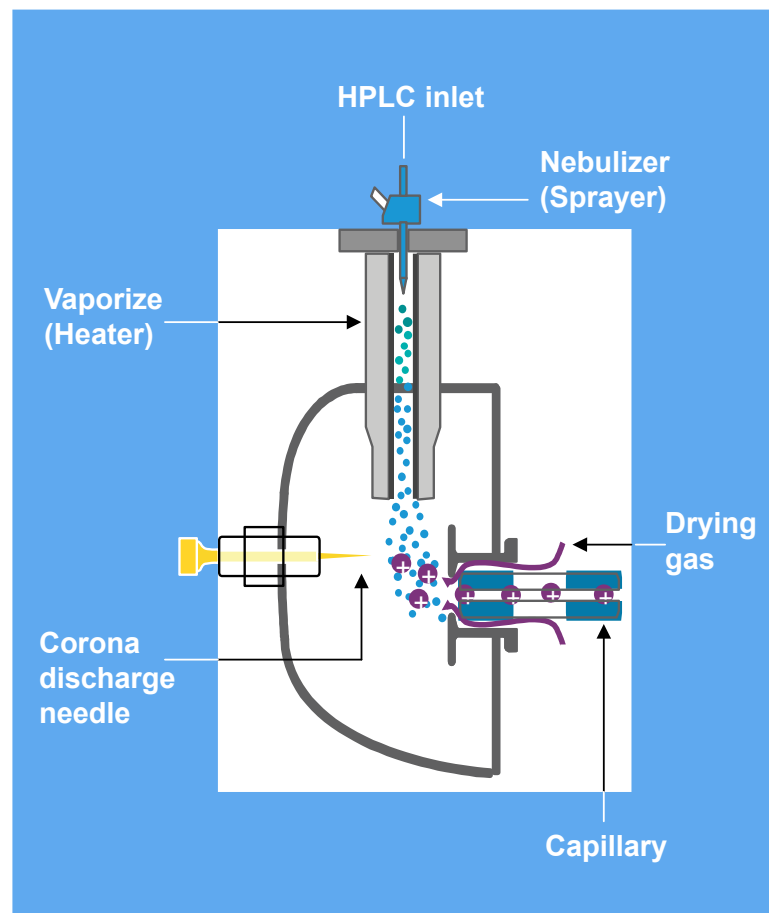

Atmospheric pressure chemical ionization source
Source: [LC/MS concept guides](#) (p 27)

How It Works

Ionization – APCI Process

This shows the evaporation and ionization processes of APCI.

Note that the analyte is not ionized until after evaporation and after the reagent gas is ionized.

The reagent gas then transfers a charge to the analyte.

Typically APCI generates just singly charged ions, however, it is possible to get doubly charged ions where the charge sites are held apart (usually by a hydrophobic region).

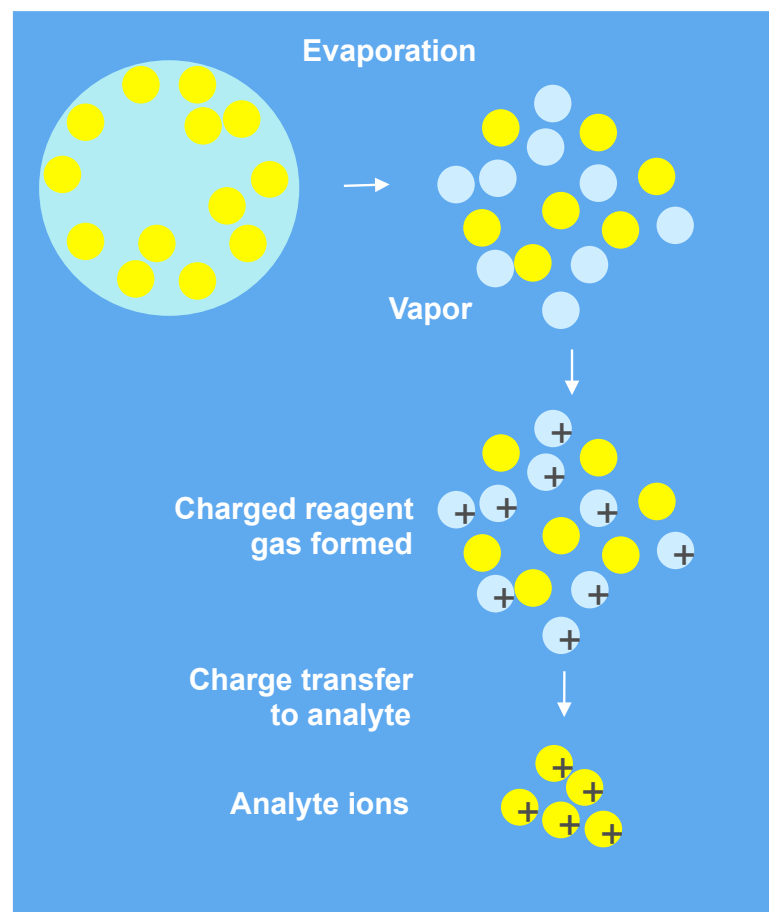

How It Works

Ionization – Atmospheric Pressure Photo Ionization (APPI)

With the APPI technique, LC eluent passes through a nebulizing needle to create a fine spray.

Droplets are fully vaporized in a heated ceramic tube.

The gas/vapor mixture passes through the ultraviolet light of a krypton lamp to ionize the sample molecules. The sample ions are then introduced into the capillary.

APPI is applicable to many of the same compounds that are typically analyzed by APCI. APPI has proven particularly valuable for analysis of non-polar, aromatic compounds.

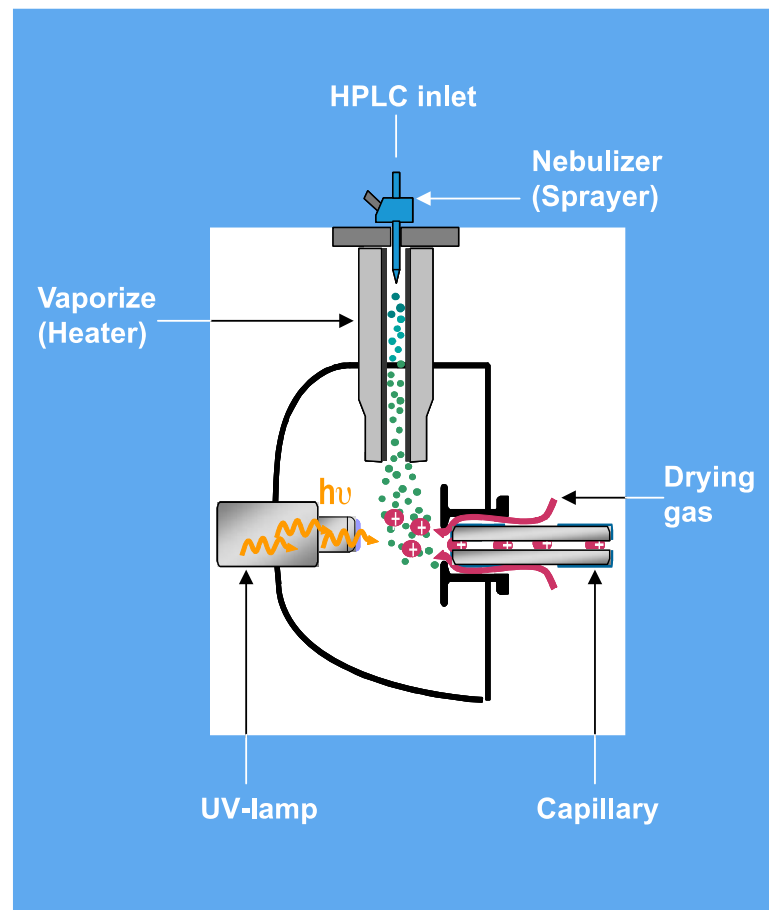

Atmospheric pressure photoionization source
Source: [LC/MS concept guides](#) (p 29)

How It Works

Ionization – APPI Process

This shows the evaporation and ionization processes of photoionization.

APPI and APCI are similar, with APPI substituting a lamp for the corona needle for ionization. APPI often also uses an additional solvent or mobile phase modifier, called a “dopant” (*D*), to assist with the photoionization process.

Direct APPI:

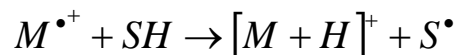
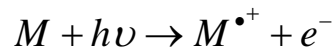

Dopant APPI:

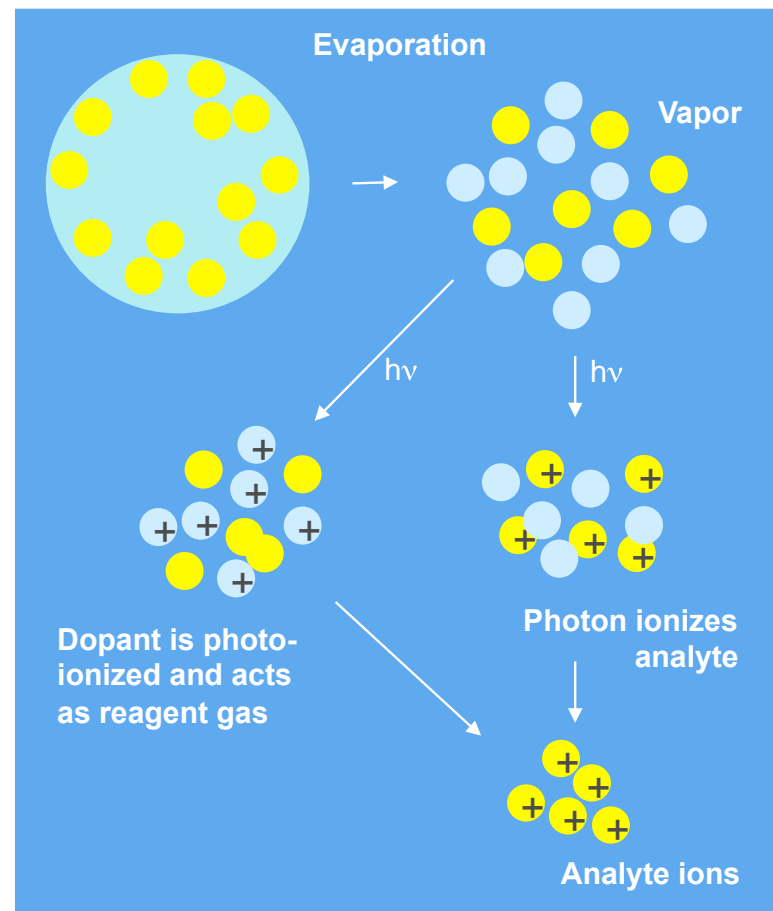
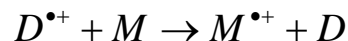
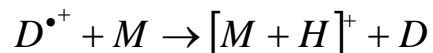
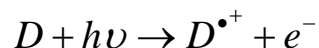

How It Works

Ionization – Multi Mode Ionization (MMI)

The multimode source is an ion source that can operate in three different modes:

- APCI
- ESI
- Simultaneous APCI/ESI

It incorporates two electrically separated, optimized zones – one for ESI and one for APCI. During simultaneous APCI/ESI, ions from both ionization modes enter the capillary and are analyzed simultaneously by the mass spectrometer.

MMI is useful for screening of unknowns, or whenever samples contain a mixture of compounds where some respond by ESI and some respond by APCI.

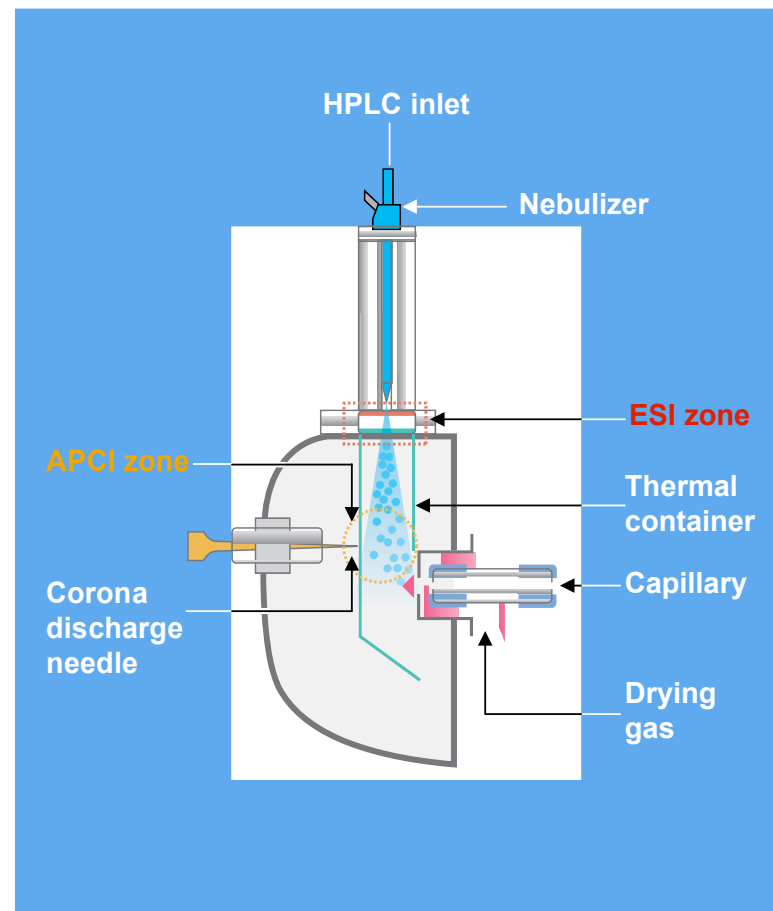

Multimode source

Source: [LC/MS concept guides](#) (p 30)

How It Works

Ionization – Matrix-Assisted Laser Desorption/Ionization (MALDI)

Matrix-assisted laser desorption/ionization (MALDI) is a soft ionization technique.

Sample is mixed with matrix and applied to a metal plate.

A pulsed laser irradiates the sample, triggering ablation and desorption.

The analyte molecules are ionized in the hot plume of ablated gases.

Ions are accelerated into the mass spectrometer.

Suitable molecules:

- Biomolecules (DNA, proteins, sugars)
- Large organic molecules (polymers)

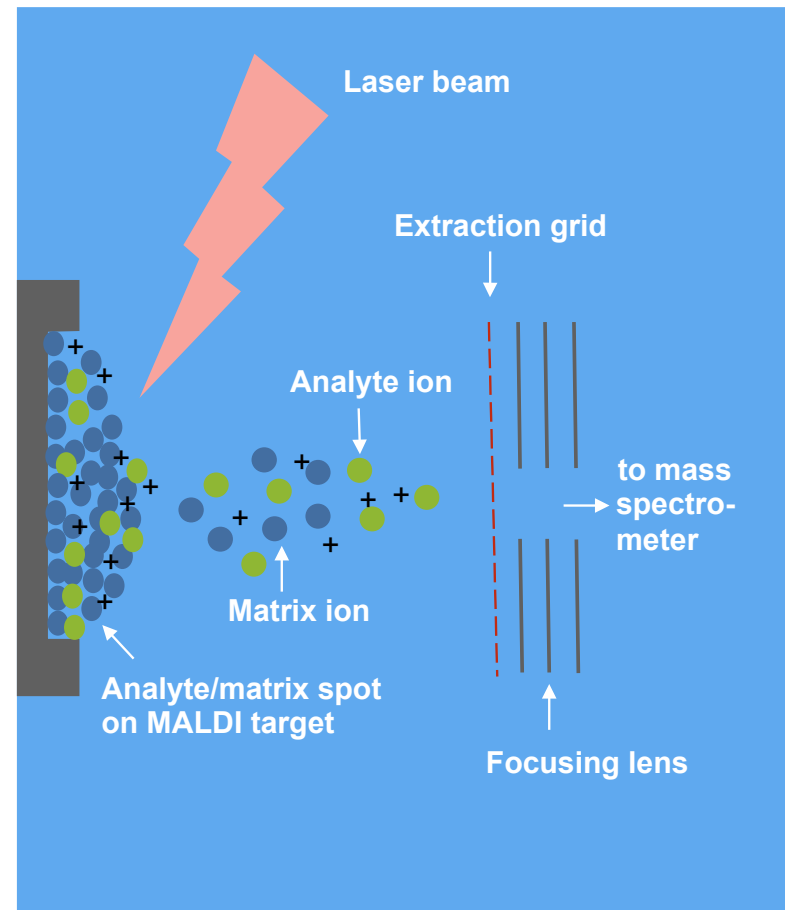

How It Works

Ionization – Inductively Coupled Plasma (ICP)

An inductively coupled plasma (ICP) instrument uses a plasma source in which the energy is supplied by electric currents which are produced by electro-magnetic induction, that is, by time varying magnetic fields. The plasma is so energetic it reduces molecules to ionized elements.

There are different types of ICP geometries available that can be coupled to different technologies:

- ICP-AES Atomic Emission Spectroscopy
- ICP-OES Optical Emission Spectroscopy
- ICP-MS Mass Spectrometry
- ICP-RIE Reactive-Ion Etching

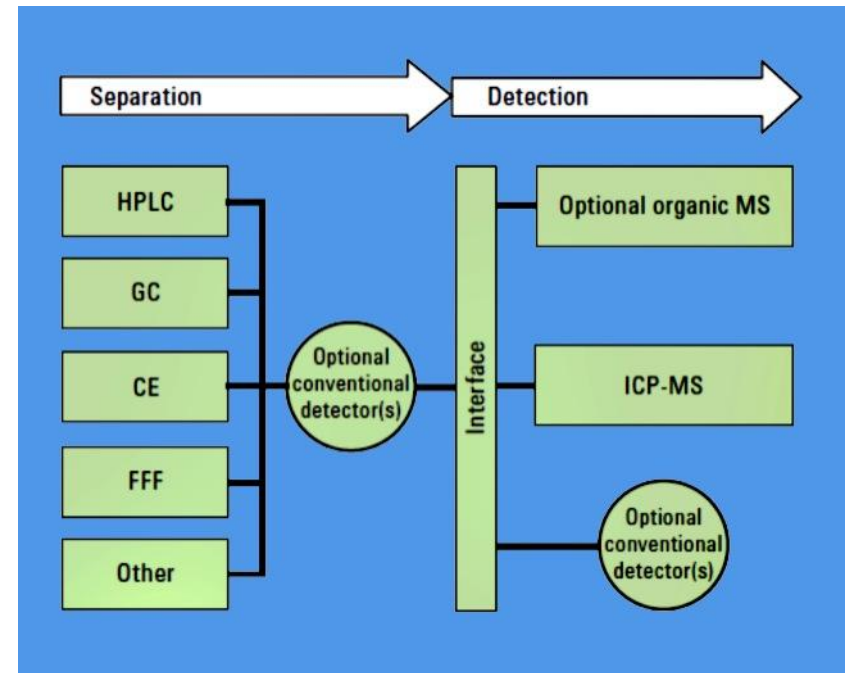

Schematic diagram showing the interrelationships of the various components in a hyphenated ICP-MS system

How It Works

Mass Analyzer

After ionization and ion transport, analytes enter the mass analyzer.

The mass spectrometer measures the ion signals resulting in a mass spectra, which can provide valuable information about the molecular weight, structure, identity, and quantity of a compound.

There are different types of mass analyzers:

- Single Quadrupole (SQ)
- Triple Quadrupole (QQQ)
- Time-of-Flight (TOF)
- Ion Trap (IT)



How It Works

Mass Analyzer – Single Quadrupole (SQ)

Charged ions generated in the ion source enter the mass analyzer.

The quadrupole mass analyzer is scanned sequentially such that only a single ion m/z may be passed at one time. All other ions are lost.

m/z - mass-to-charge ratio:

Mass of an ion (Daltons or u) divided by the number of charges on the ion

Information received: **MS only**

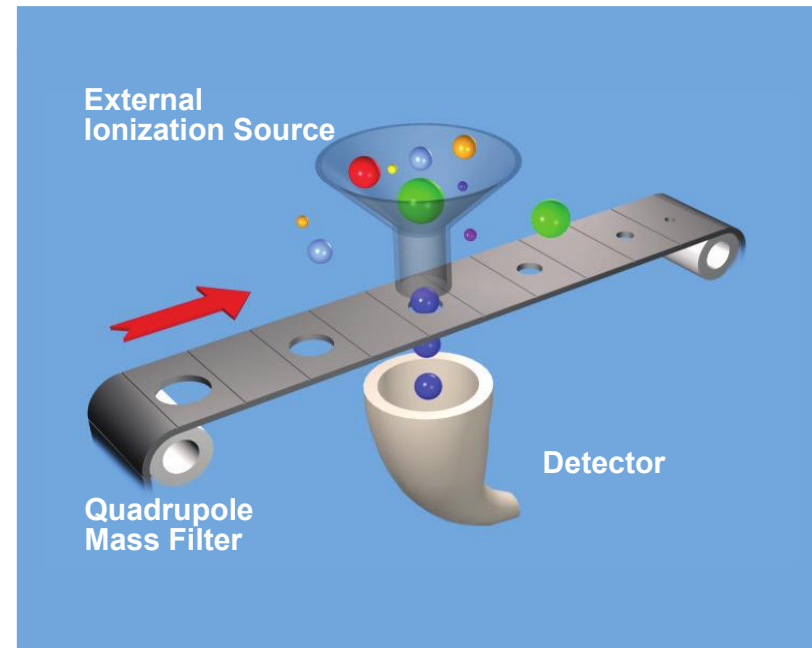

Conceptual model – Single quadrupole

How It Works

Mass Analyzer – Single Quadrupole (SQ)

Single Ion Monitoring (SIM)

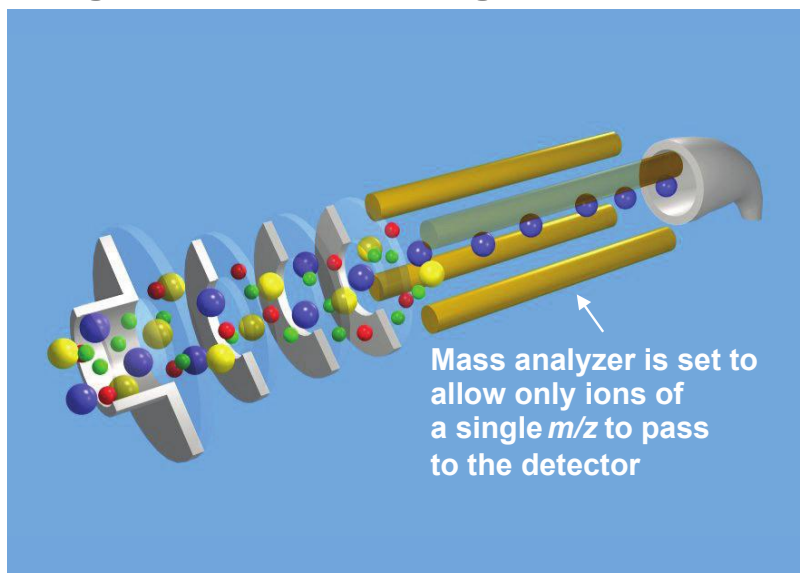

A target ion with specific m/z is monitored. SIM on a single quad permits the best sensitivity for quantitation, however it lacks specificity.

Scan Mode

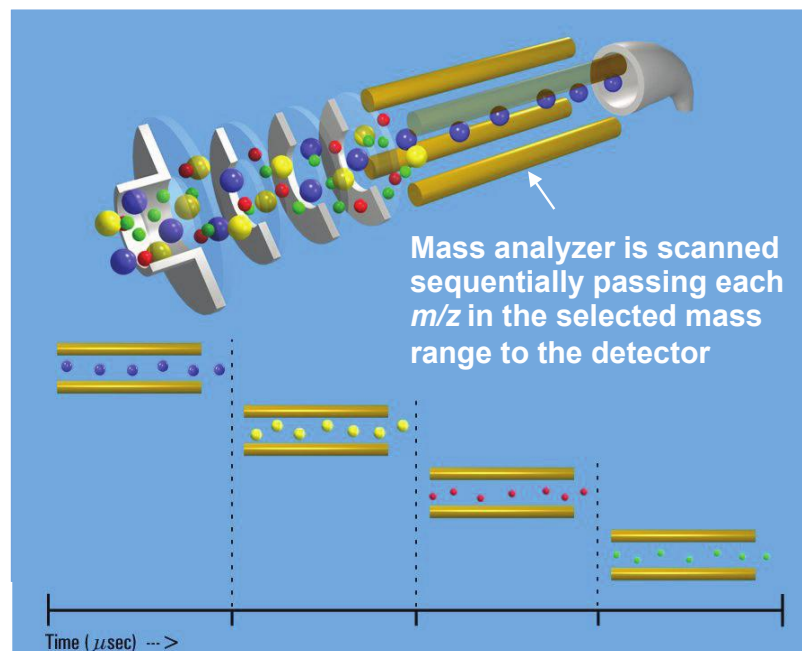

In Scan MS mode, the quadrupole mass analyzer is scanned sequentially allowing only 1 m/z at a time to pass to the detector.

How It Works

Mass Analyzer – Triple Quadrupole (QQQ)

Charged ions generated in the ion source enter the mass analyzer.

The analyzer consists of three quadrupoles (Q1-Q3) and therefore several modes of operation resulting in different information.

A common set is the following:

- Q1: used as a filter for specific m/z (precursor ion)
- Q2: used as collision cell to fragment the precursor ion and generate product ions
- Q3: set to specific m/z (SRM or MRM) or scan mode (product ion scan)

Information received: **MS and MS/MS**

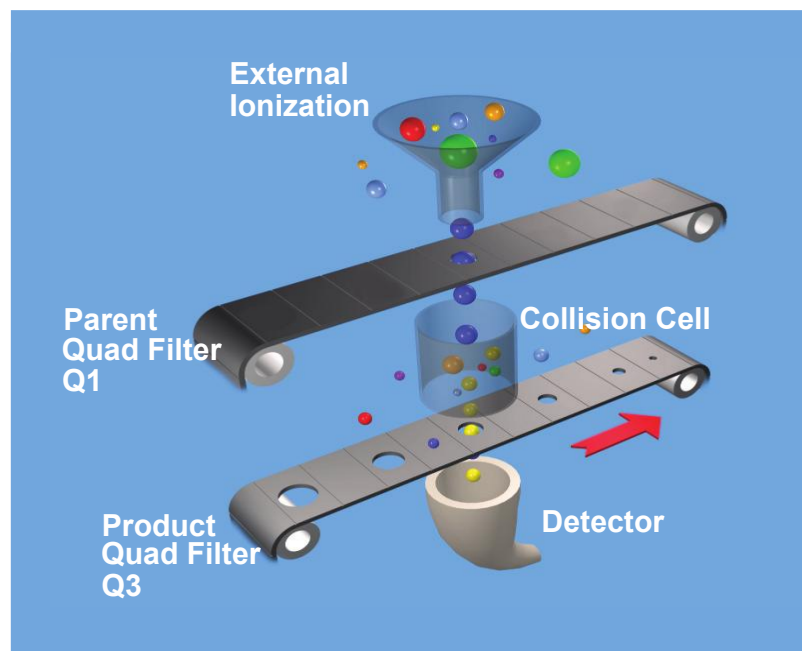

Conceptual model – Triple quadrupole
Schematic shows SRM mode

How It Works

Mass Analyzer – Triple Quadrupole (QQQ)

Multiple Reaction Monitoring (MRM)

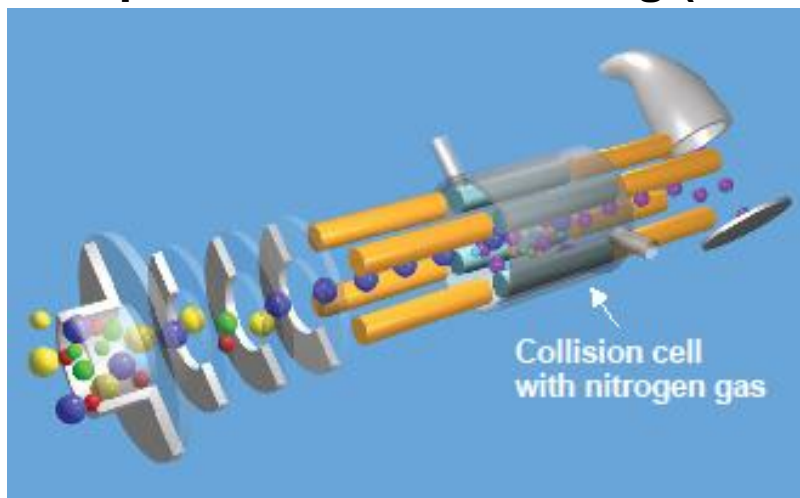

Precursor ions with single m/z are passing to collision cell. Fragment ions are generated by collision with nitrogen molecules. Q3 is set to single m/z of specific fragment ion. This is a very sensitive method and used for quantitation.

Full Scan MS/MS Mode

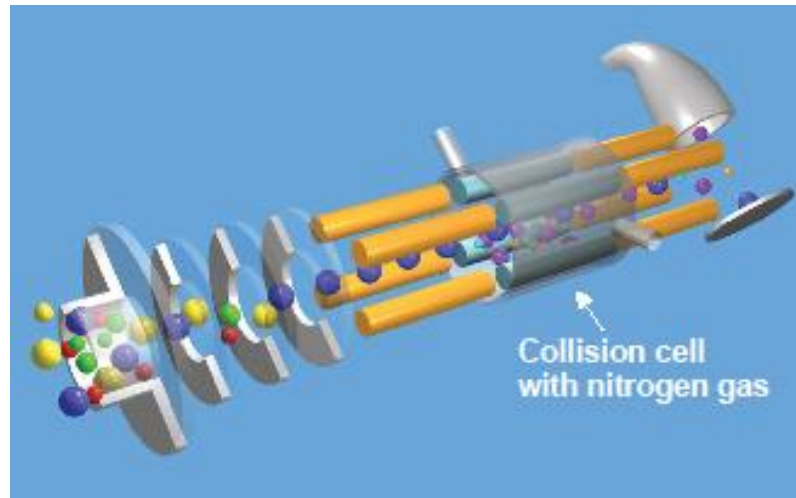

The difference in full scan mode compared to SRM/MRM is the scanning function. Q3 is scanned sequentially allowing only 1 m/z at a time to pass to the detector. A product ion spectrum is generated. This mode of operation is less sensitive compared to SRM/MRM.

How It Works

Mass Analyzer – Ion Trap (IT)

Charged ions generated in the ion source enter the mass analyzer. All ions of the selected polarity over the selected mass range can be stored at once in the trap. The ions can be manipulated in the ion trap mass analyzer – performing multiple isolation and fragmentation stages – until time to detect.

Instead of four parallel rods, the ion trap consists of a circular ring electrode plus two end caps that form a “trap”.

Information received: **MS and MS/MS**

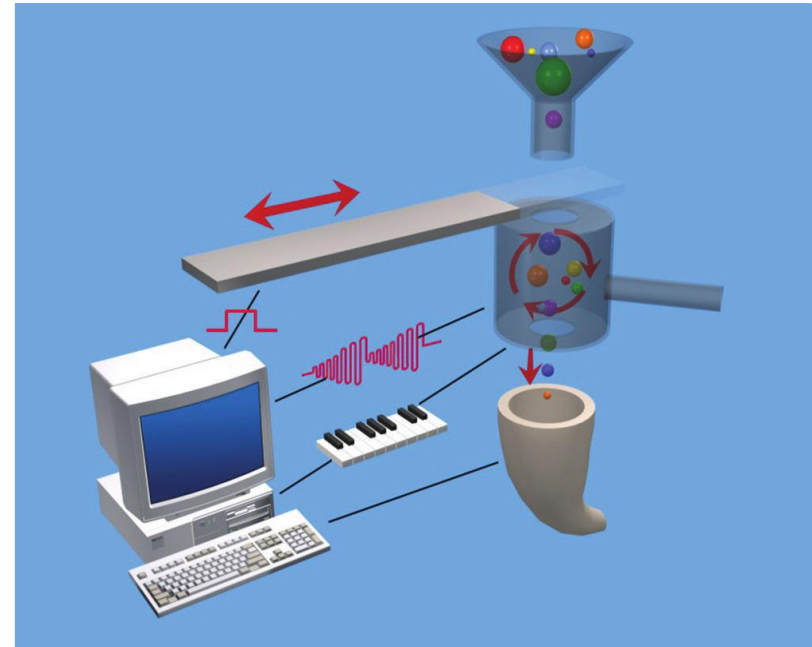

Conceptual model – Ion Trap

How It Works

Mass Analyzer – Ion Trap (IT)

Step 1: Isolation of Precursor Ion

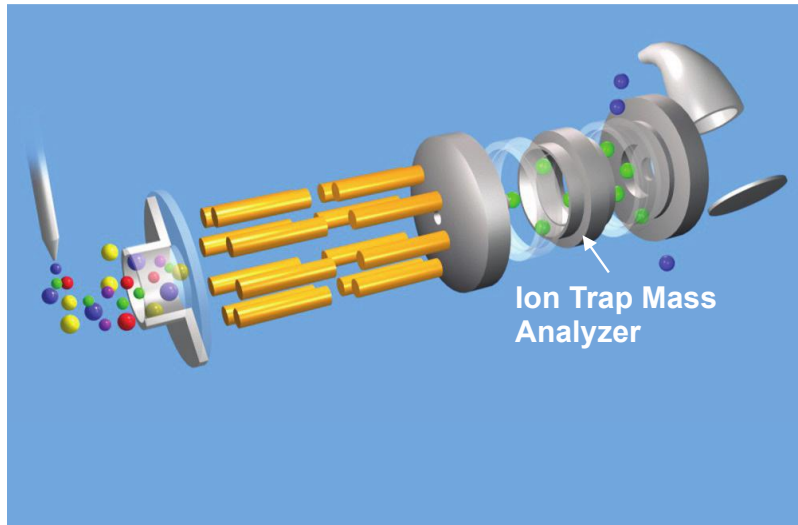

Once ion injection and accumulation are complete, the ion gate closes and ions are no longer injected into the mass analyzer. Waveforms are applied to eject masses above and below the precursor ion.

Step 2: Fragmentation of Precursor ion

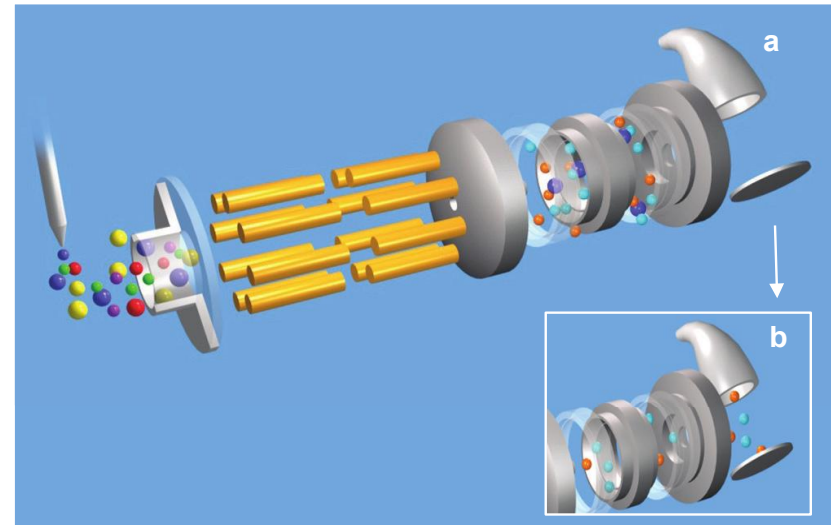

Resonance excitation of the precursor ion causes collision induced dissociation (CID) and product ions are generated (a). The full scan product ions are ejected to the detector (b).

How It Works

Mass Analyzer – Time-of-Flight (TOF)

Charged ions generated in the ion source enter the mass analyzer.

Analyzer components:

- Mass filter (Q1), optional
- Flight tube
- Collision cell (Q-TOF)

After ions have passed the quadrupole or collision cell they arrive at the ion pulser. A high voltage pulse is applied which accelerates the ions into the flight tube. An ion mirror at the end of the tube reflects the ions and sends them to the detector that records their time of arrival.

Information received:

TOF: **MS only**

Q-TOF: **MS and MS/MS**

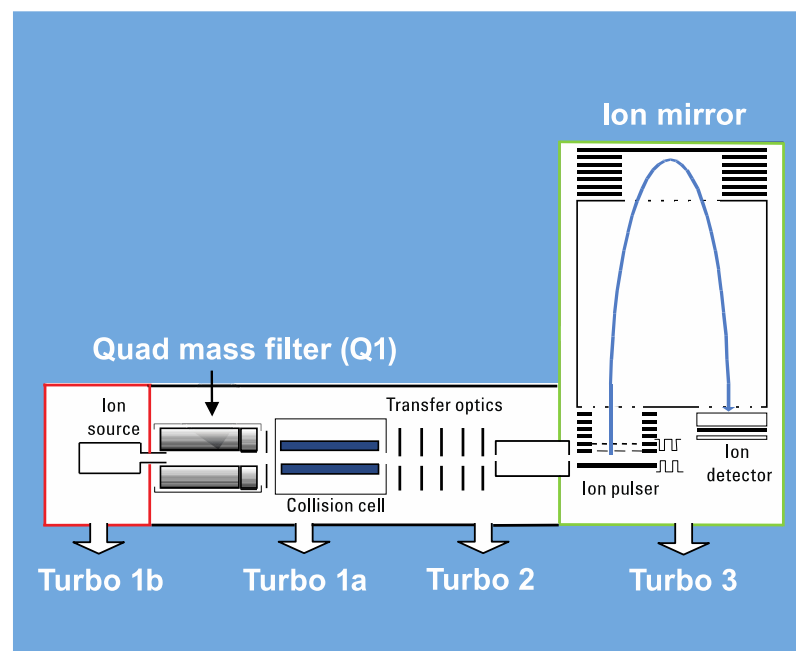

Schematic of Time-of-Flight mass spectrometer.

Source: [Time-of-Flight Mass Spectrometry](#)

Graphic shows a Q-TOF

How It Works

Mass Analyzer – Time-of-Flight (TOF)

The flight time (t) for each mass is unique and is determined by the energy (E) to which an ion is accelerated, the distance (d) it has to travel, and m/z .

$$E = 1/2mv^2$$

which is solved for m looks like:

$$m = 2E / v^2$$

and solved for v looks like:

$$v = \sqrt{(2E / m)}$$

equation 1

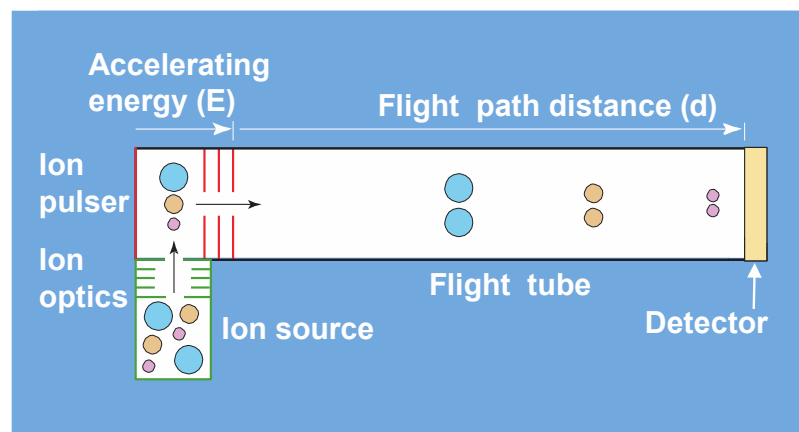

The equation says that for a given kinetic energy, E , smaller masses will have greater velocities than larger masses. Ions with lower masses arrive at the detector earlier.

Velocity is determined (and consequently the mass) by measuring the time it takes an ion to reach the detector.

How It Works

Mass Analyzer – Time-of-Flight (TOF)

The second equation is the familiar velocity (v) equals distance (d) divided by time (t): $v = d / t$

Combining equation 1 and 2 yields: $m = (2E / d^2)t^2$

For a given energy (E) and distance, the mass is proportional to the square of the flight time of the ion. E and d are kept constant and summarized in variable A which leads to a simplified equation: $m = A \cdot t^2$

To be really precise, a time delay for applying the high voltage needs to be considered as well: $t = t_m - t_0$

This results in the final equation: $m = A(t_m - t_0)^2$

Results

Example 1

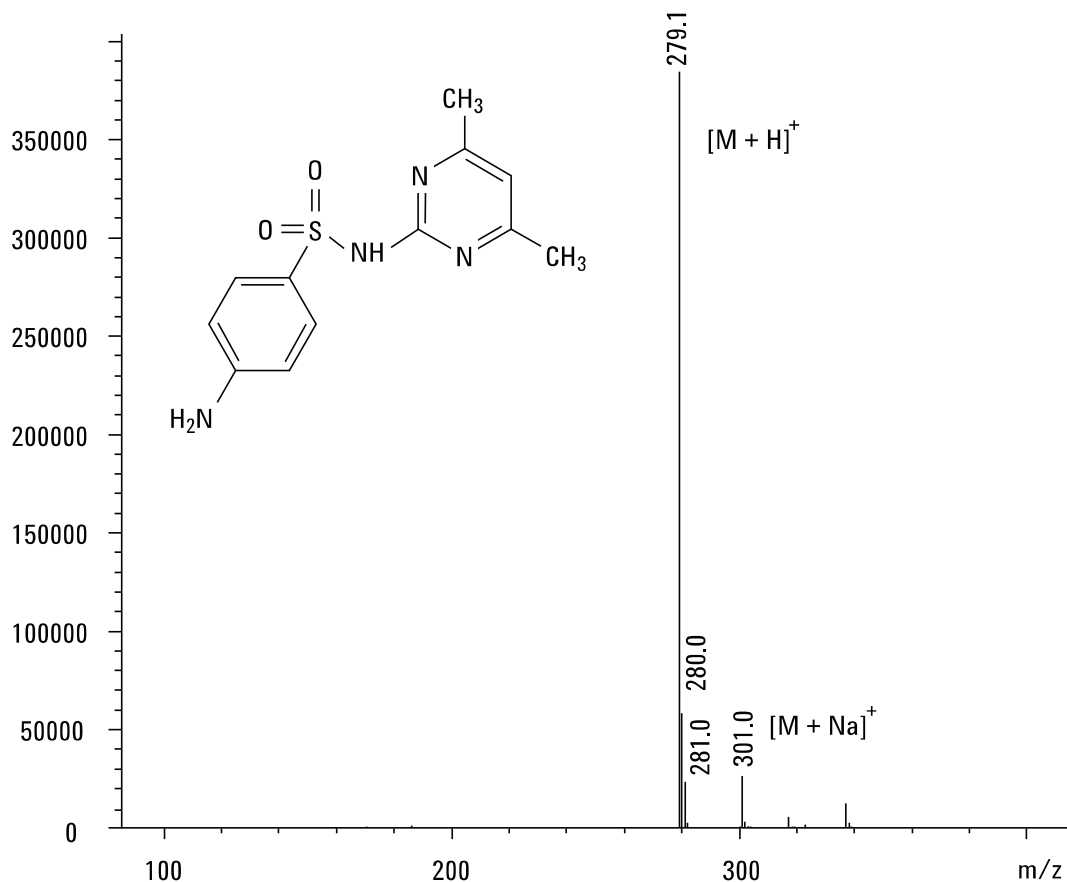

Mass spectrum of [sulfmethazine](#) analyzed with a single quadrupole mass analyzer

Molecular Formula: **C₁₂H₁₄N₄O₂S**
[M+H]⁺: 279.33

Mass spectrum of sulfmethazine.
Source: [Agilent 6100 Series Quadrupole LC/MS Systems](#) (p 17)

Results

Example 2

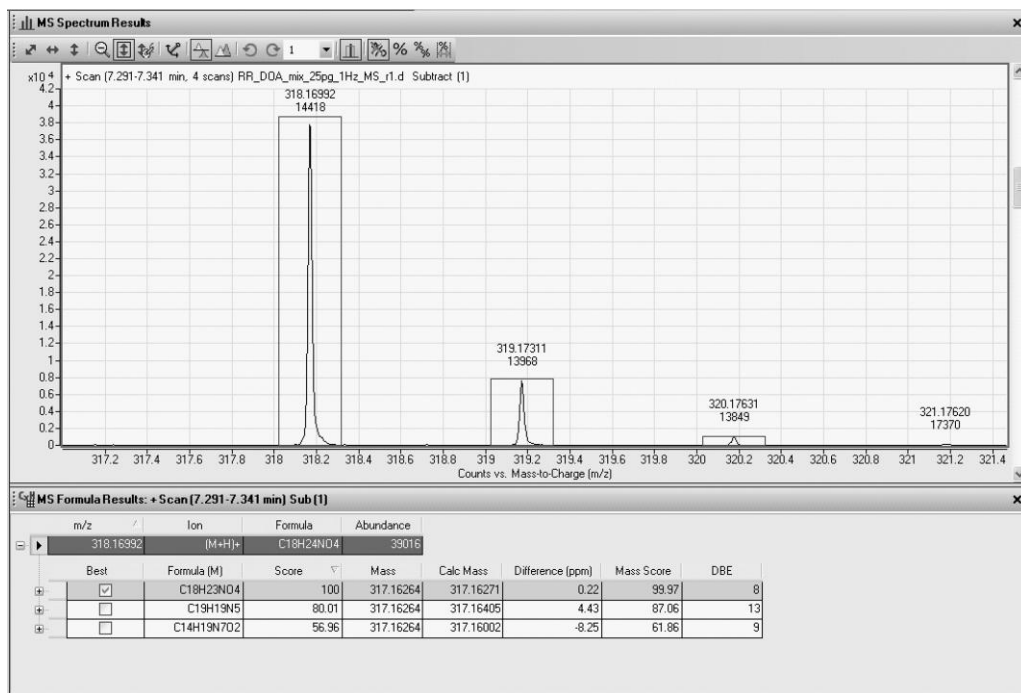

Mass spectrum of [cocaethylene](#) with a Q-TOF mass analyzer

Molecular Formula: **C₁₈H₂₃NO₄**
[M+H]⁺: **318.387**

Mass spectrum of Cocaethylene.
Source: [A comparison of several LC/MS techniques for use in toxicology](#) (Fig 36, p 37)

Results

Single Quad vs. High Resolution TOF

The analysis with a Single (Triple) quadrupole delivers nominal mass information (low resolving power), Time-of-Flight instruments can deliver accurate mass information (high resolving power).

Continuous calibration of a TOF system is needed for time-of-flight analysis to ensure best possible mass accuracy. Measurements typically deviate by only a few parts per million (ppm).

With sufficient mass resolution and mass accuracy, a TOF mass spectrometer can positively confirm elemental composition.

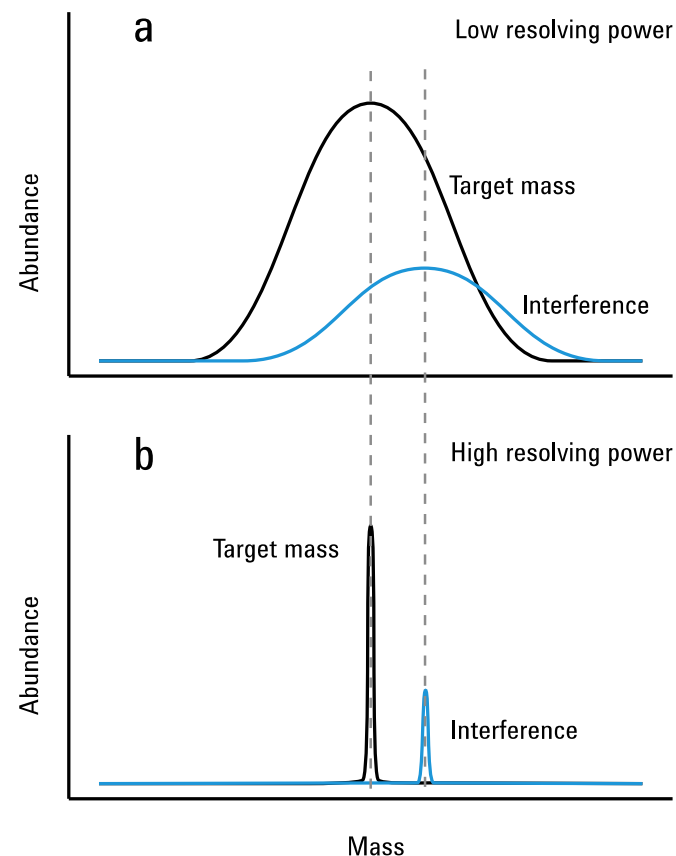

Resolving power of Single quadrupole (a) versus Time-of-Flight (b) Source: [5989-2549EN](#) (p 14)

Results

Single Quad vs. TOF

Typical Single Quadrupole mass spectrum

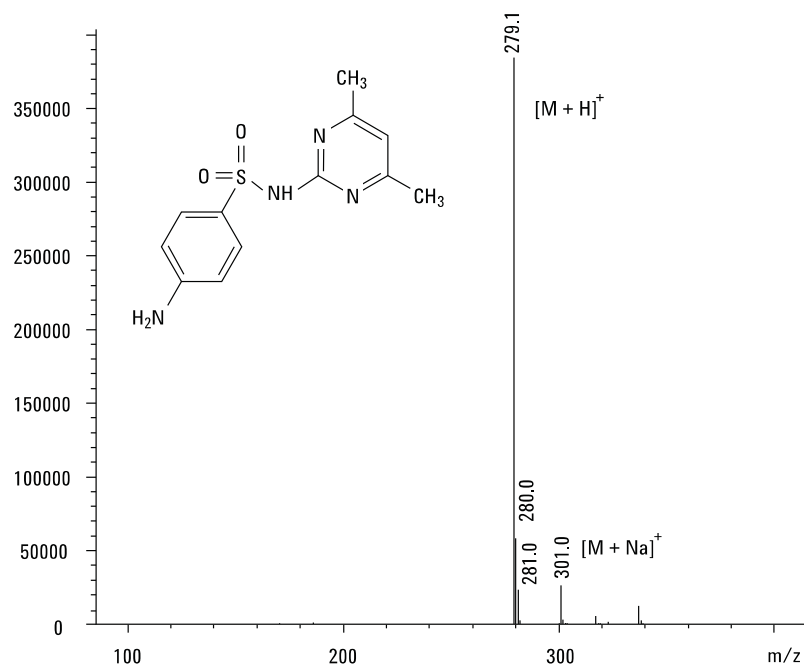

Mass spectrum of sulfamethazine.
Source: [G1960-90083](#) (p 17)

Typical TOF mass spectrum

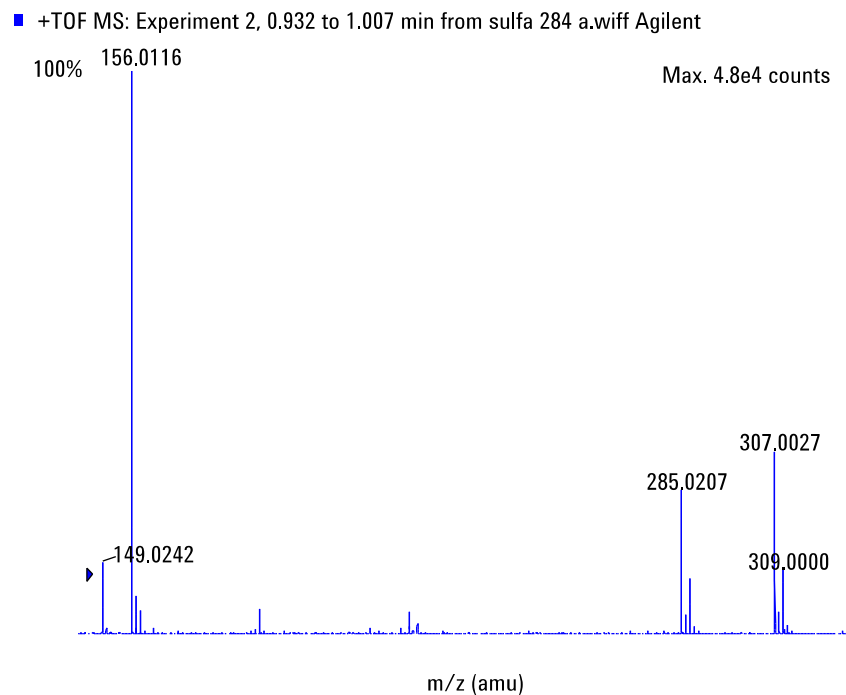

Mass spectrum of sulfachloropyridazine with adduct and fragment ions. Source: [5989-2549EN](#) (p 25)

Results

Multiply Charged Ions and Deconvolution

Depending on the analyzed molecule and the ionization technique, multiple charged ions can be generated.

Small molecules and APCI delivers single charged molecules:

The measured m/z corresponds to the molecular weight after subtracting (positive ion) or adding (negative ion) the charge carrier.

For large molecules (peptides, proteins) ionized with ESI, more than one potential charge site (for protonation or deprotonation) is available which can result in multiply charged ions:

This makes large molecules like antibodies (> 1 Mio Da) accessible to mass spectrometry since the measured ions are shifted to a more readily measure m/z range.

A mathematic algorithm is needed to determine the real molecular weight from the measured m/z . This process is known as **deconvolution**.

Results

Multiply Charged Ions and Deconvolution – Example

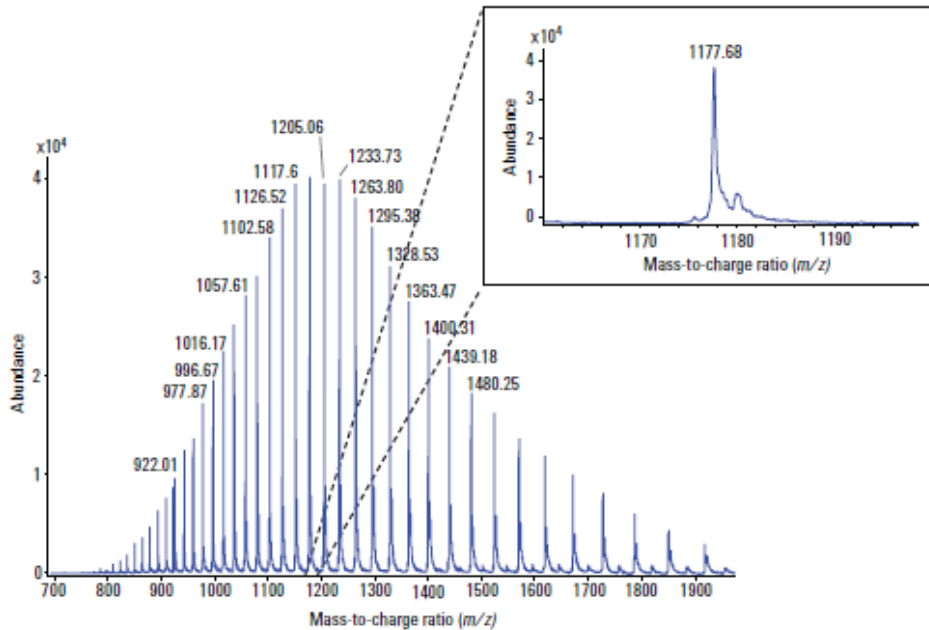

Mass spectrum of expressed glutamine synthetase.

Expected mass of unmodified glutamine synthetase:
51,772.7 u

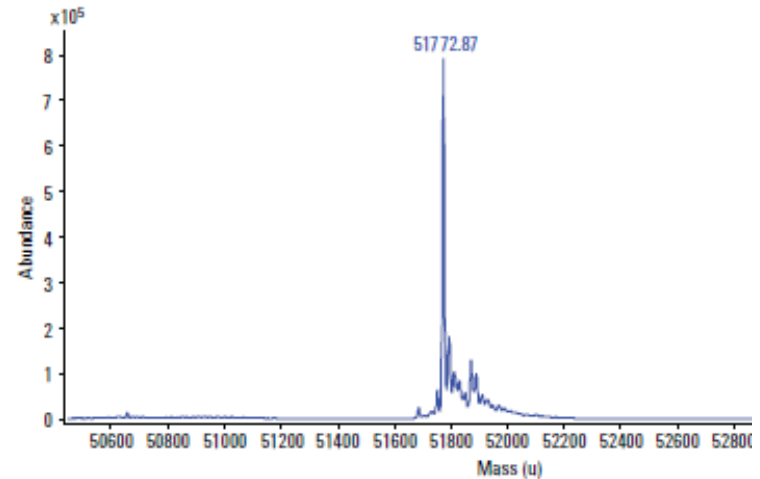

Deconvoluted mass spectrum of expressed glutamine synthetase.

Source: [Accurate-Mass LC/TOF-MS for Molecular Weight Confirmation of Intact Proteins](#) (Fig 1, p 4)

Abbreviations

Abbreviation	Definition
APCI	Atmospheric Pressure Chemical Ionization
APPI	Atmospheric Pressure Photo Ionization
CI	Chemical Ionization
CID	Collision Induced Dissociation
<i>D</i>	Dopant (APPI)
Da	Dalton
EI	Electron Impact
ESI	Electrospray Ionization
GC	Gas Chromatography
GC/MS	Gas Chromatography Mass Spectrometry
ICP	Inductively Coupled Plasma
IT	Ion Trap

Abbreviation	Definition
LC/MS	Liquid Chromatography Mass Spectrometry
<i>M</i>	Molecule Ion
MALDI	Matrix Assisted Laser Desorption Ionization
MMI	Multimode Ionization
MS	Mass Spectrometry
<i>m/z</i>	Mass to Charge Ratio
QQQ	Triple Quadrupole
SIM	Single Ion Monitoring
SH	Solvent Molecules
SQ	Single Quadrupole
MRM	Multiple Reaction Monitoring
(Q) - TOF	Time-of-Flight

Further Information

For more information on products from Agilent, visit www.agilent.com or www.agilent.com/chem/academia

For questions or suggestions about this presentation, contact academia.team@agilent.com

Publication	Title	Pub. No.
Manual	Agilent 7000 Series Triple Quad GC/MS Operation Manual	G7000-90044
Guide	Agilent 6100 Series Quadruple LC/MS systems – Concepts Guide	G1960-90083
Application compendium	Time-of-Flight Solutions in Pharmaceutical Development – the Power of Accurate Mass	5989-2549EN
Technical Overview	Time-of-Flight Mass Spectrometry	5990-9207EN
Application	Accurate-Mass LC/TOF-MS for Molecular Weight Confirmation of Intact Proteins	5989-7406EN
Application	A Comparison of Several LC/MS Techniques for Use in Toxicology	5990-3450EN
Videos	www.agilent.com/chem/teachingresources	
Images	www.agilent.com/chem/teachingresources	





THANK YOU

Publication number 5991-5857EN

