

Biotage® Extrahera™ LV-200

User Manual



Biotage® Extrahera™ LV-200

User Manual

CONTENTS

2	Biotage® Extrahera™ LV-200	19	Biotage® Extrahera™ GLP Features
1	System Overview	20	Set Up and Start a Run
1	Liquid Handling	20	Verify the System Setup
2	Working Area	20	Select the Method
2	Carousel and Lifter	20	Load the Extraction Media
2	Dual Flow Extraction (DFE)	21	Adjust the Air Pressure
3	Columns, Plates, and Sample Tubes	21	Load Solvent Pipette Tips
3	Pressure Unit	22	Load Sample Pipette Tips
3	Waste Kit and Vacuum	23	Assign Solvent Bottles and Prime
3	Safety	24	Assign Manually Loaded Solvents (Optional)
4	Visual and Audible Alarm	24	Load Carousel Plate(s)
4	Lighting	25	Enter the Report Name and a Comment (Optional)
4	Adjustable Touch Screen	25	Load the Sample Plate and Enter the Plate ID
4	Barcode and QR Scanner (Optional)	25	Start the Run
4	Biotage® Extrahera™ GLP Software License (Optional)	25	Biotage® Extrahera™ GLP Features
5	Power Failure	26	Monitor and Control a Run
6	Manage Solvents, Sample Types, Plates, Racks, and Tips	26	Monitor the Run
6	Predefined Entries	26	Pause or Abort the Run
6	Custom Entries	27	Post-Run Activities
6	Manage Solvents	27	Biotage® Extrahera™ GLP Features
8	Manage Sample Types	28	View, Export, and Delete Reports
9	Manage Extraction Media	28	View a Report
10	Manage Sample Plates	28	Export Reports
11	Manage Pipette Tips	28	Delete Reports
11	Manage Dual Flow Extraction Consumables	28	Biotage® Extrahera™ GLP Features
12	Biotage® Extrahera™ GLP Features	29	Enable/Disable the DFE Mode
13	Set Up a Method	29	Enable the DFE Mode
13	Predefined Methods	29	Disable the DFE Mode
13	New, Copy, and Edit a Method	30	Maintenance
14	Method Operations	30	Change the System Settings
15	Method Parameters	30	Export the System Logs
17	DFE Method Parameters	30	Clean the Exterior of the System
18	Biotage® Extrahera™ GLP Features	31	Clean the Interior of the System
19	Export, Import, and Delete Methods	32	Replace the Solvent Tubing
19	Export Methods	33	Clean or Replace the Waste Tubing
19	Import Methods	34	Pipette Pump Calibration and Adjustment
19	Delete Methods	35	Replace the Pressure Head Seal
		36	Replace the Fuses
		36	Drain the Filter Unit
		36	Replace the Filters in the Filter Unit

37	Manual Control
37	Door
37	Maintenance
37	Method Development
38	Set Up Reminders for Pipette Pump Calibrations
39	Troubleshooting
39	Dual Flow Extraction Tips
39	Pipette Pump
39	Pipetting Tips
39	Power Failure
40	Pressure Head
40	Pressurized Air and Nitrogen
40	Retaining Clips
40	Robot
40	Sample Cross-Contamination
40	Solvent Contamination
41	Solvent Pumps
41	Ventilation Fan
41	Waste and Lifter
41	Biotage® Extrahera™ GLP Features
42	General Information
42	Consumables and Accessories
42	Manufacturer
42	Contact Us

System Overview

Biotage® Extrahera™ LV-200 is an automation system for sample preparation methods for 96 positions plates and column racks. Extrahera LV-200 can automate:

- » Supported Liquid Extraction (SLE),
- » Solid Phase Extraction (SPE),
- » Phospholipid Depletion (PLD),
- » Protein Precipitation (PPT),
- » Dual Mode Extraction with in-situ hydrolysis (Hydro DME+), and
- » Dual Flow Extraction (DFE).

The system also offers two filtration methods, Filtration (extraction media already containing sample) and Filtration+ (with sample load and optional pretreatment).

Liquid Handling

Extrahera LV-200 is equipped with five solvent inlets found on the right hand side of the system (S1-S5). Solvents are pumped into five 25 mL disposable solvent reservoirs inside the system (in position 5 on the working area) where the robot can aspirate solvent using up to eight disposable pipette tips; see Figure 1.

The system scans the solvent level in the reservoirs (S1-S5), and fills/refills when necessary, each time a run is started and every 30 minutes during the run. Reservoirs containing solvents that are defined as highly volatile are filled just before the solvent is used for the first time in the run.



Figure 1. The robot is aspirating solvent from the solvent reservoirs inside the system using disposable pipette tips.

It is possible to have an extra solvent rack with five 25 mL, 40 mL, or 100 mL solvent reservoirs in position 6 on the working area. These reservoirs have to be filled manually by the user. Note that when running a DFE method, wash and elution solvents are loaded into the carousel (automatically or manually) and position 6 is used for the DFE column tips.

To ensure that the system cannot be set to aspirate more liquid into a pipette tip than it can accommodate, the maximum aspiration volume has to be specified for each pipette tip that is configured in the software.

After completion of a pump operation, the robot can be programmed to move the pipette tips either back to the pipette rack (to be reused) or to the pipette tip waste bin. Note that it is only possible to reuse a sample pipette tip when mixing following pretreatment and when loading a sample in aliquots; see "Large Volumes" below.

The system contains corrosion sensitive parts. Best practice is to avoid sustained continuous exposure to acidic and basic vapors by always removing the solvent reservoirs when the system is not in use, and cleaning the system following usage. Usage of concentrated strong acids (e.g. TFA and TCA) and strong inorganic acids (e.g. nitric, sulfuric, hydrochloric, and perchloric acids) in the solvent pumps is not supported.

Large Volumes

When a sample/solvent volume exceeds the specified capacity of the selected extraction plate or columns, the sample/solvent will be dispensed in aliquots, with application of positive pressure in between aliquots.

A user can choose to either reuse the sample pipette tip or use a new sample pipette tip for each aliquot. This is defined when setting up a method in the software's **Manage Methods** view. If the run requires more than the available quantity of sample pipette tips, the system will automatically pause when it runs out of tips and prompt the user to load more.

Smart Sample Loading

The Smart Sample Loading feature allows the pipette tips to move down into the sample plate/rack at a speed that enables the tips to continuously aspirate slightly below the sample surface without aspirating air. When the pipette tips have aspirated the required sample volume or are full, they stop.

To get the optimal Smart Sample Loading performance, set up the sample plate according to the instructions on page 10.

Working Area

The working area has seven positions (see Figure 2):

- » **1:** Solvent pipette tips.
- » **2:** Sample pipette tips.
- » **3:** Extraction plate or columns.
- » **4:** Sample plate.
- » **5:** Solvent reservoirs, 5 x 25 mL. Filled using the five solvent pumps.
- » **6:** Optional solvent reservoirs, 5 x 25 mL, 5 x 40 mL, or 5 x 100 mL (manually filled). Note that the 100 mL reservoir has a maximum fill volume of 90 mL. Additional solvent tips, 50 µL, 200 µL.
- » **WASTE:** Waste bin for used pipette tips.

Note: A different setup is used for dual flow chromatography; see page 2.

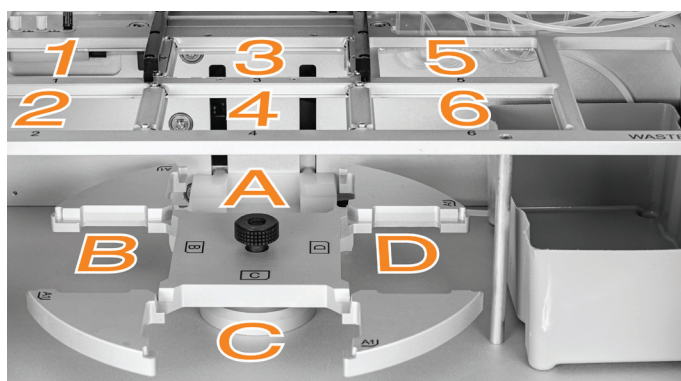

Figure 2. The working area has seven positions (1-6 and WASTE) and the carousel has four positions (A-D).

Carousel and Lifter

The carousel has three positions for collection plates (**A-C**) and one for a flow-through plate (**D**), which is used for guiding waste into the extraction waste collector eliminating the risk of cross-contamination.

Before each operation in the method, the carousel moves the flow-through plate or the specified collection plate to the inner carousel position. When in position, the plate is moved up by a lifter into a position just underneath the extraction plate or columns (see Figure 3), so that the Luer fittings of the plate or columns cannot splash droplets onto each other or adjacent wells during the operation.

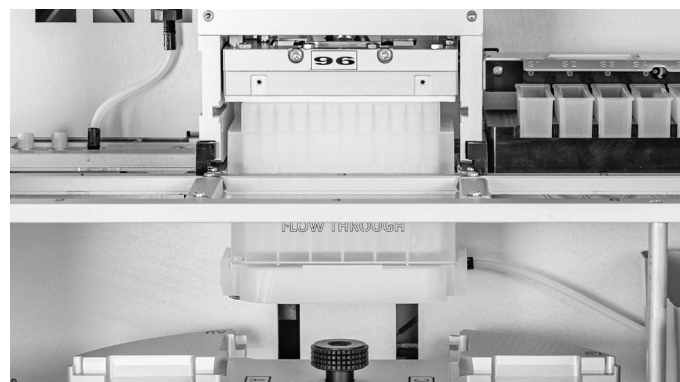

Figure 3. The plate is lifted up from the carousel to just underneath the extraction plate or columns, located in position 3 on the working area.

Dual Flow Extraction (DFE)

In dual flow chromatography, the pressure unit is not used and the extraction media (the DFE column tips) are loaded into position **6** on the working area.

Wash and elution steps are performed in position **3** using plates that are loaded into the carousel. If the method does not require a waste position, a maximum of four wash/elution plates can be used (**A-D**). Each plate can be filled either manually or by the system using one of the solvents in position **5** (S₁-S₅). In other words, if all the wash/elution plates are filled by the user, the method can use a total of up to nine different solvents.

To process a DFE method, the plate/rack frame in position **3** on the working area must be removed so that the carousel plates can be moved up by the lifter into a position where they can be accessed by pipette and DFE column tips. There is also a DFE software option that has to be enabled. For more information, see "Enable/Disable the DFE Mode" on page 29.



Figure 4. When running a DFE method, wash and elution plates are loaded into the carousel. By removing the plate/rack frame in position 3 on the working area, the carousel plates can be moved up into a position where the pipette and DFE column tips can access them.

Columns, Plates, and Sample Tubes

The following formats are supported:

Extraction: 96-well extraction plates, 96-array plates for 1 and 2 mL wells, 96-position extraction racks for 1 mL (tablets) columns (A format), and 96-position pipette racks for 200 μ L and 1 mL DFE column tips.

Sample: 1 mL x 96 and 2 mL x 96 sample plates, and 96-position retaining plate for 1.4 mL matrix sample tubes.

Collection: 1 mL x 96 and 2 mL x 96 collection plates.

Wash/Elution Plates (DFE): 1 mL x 96 and 2 mL x 96 plates,

Flow-through plate: The flow-through plate (P/N 414201SP) is used for guiding waste into the extraction waste collector eliminating the risk of cross-contamination. The plate can be cleaned and reused.

Pressure Unit

The pressure unit is designed to process extraction plates or columns using pressurized gas.

The gas connected to the **AIR** port (at the right side of the system) is used to seal the plate or columns and its pressure has to be adjusted according to how many positions in the plate/rack that are populated. Use 6 ± 0.2 bar (0.6 ± 0.02 MPa; 87 ± 3 psi) for a fully populated extraction plate/rack and lower to approximately 4 bar (0.4 MPa; 58 psi) when 50% of the plate/rack is populated and 3 bar (0.3 MPa; 44 psi) when 25% of the plate/rack is populated.

The gas connected to the **N₂** port is used when processing samples. The processing pressure is adjustable from 0 to 5 bar in the software, while the pressure into the system has to be set to 6 ± 0.2 bar (0.6 ± 0.02 MPa; 87 ± 3 psi). The gas flow when processing is between 0 and 10 mL/min during all operations except for plate dry, where it is approximately 600 mL/min at 5 bar.

The gas applied to the samples must be according to ISO 8573-1, classification 1-6-1. This is essential to prevent sample contamination and general fouling of the pressure unit. The filter unit that is supplied with the system delivers according to ISO 8573-1, class 1-x-1. If the gas applied is not according to class x-6-x, an air dryer needs to be ordered separately (P/N 416441SP).

Note that the pressure unit is not used in dual flow chromatography.

Pressure Gradients

When setting up a method, it is possible to create pressure gradients for conditioning, equilibration, sample load, wash, collection, and elution steps. For more information, see page 16.

Waste Kit and Vacuum

A laboratory vacuum source, or a vacuum pump (sold separately, P/N 356330SP), is required for collecting the waste in the 5-liter waste reservoir outside the system. Always ensure that there is sufficient volume in the waste reservoir before starting a run.

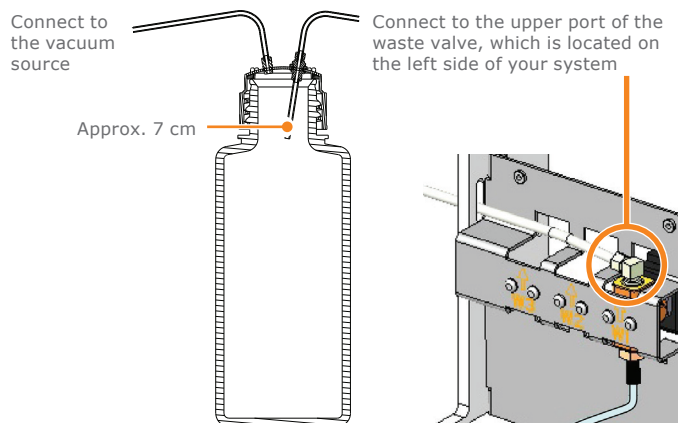

Figure 5. The setup of the waste kit.

Safety

The ventilated system enclosure protects the user against mechanical hazards and potentially harmful solvents and/or vapors. The system cannot be operated when:

- » the door is open, and/or
- » the integral system ventilation fan is not working.



Figure 6. The outlet of the Extrahera top ventilation.

Visual and Audible Alarm

The system's visual and audible alarm is triggered by non-user-initiated pauses, scheduled pauses (defined in the method), and system errors:

- » When a non-user-initiated or scheduled pause occurs, the software background flashes in blue and an alarm with short beeps sounds (see Figure 7).
- » If a system error occurs, the software background flashes in red and an alarm with longer beeps sounds (see Figure 7).

The alarm stops when the touch screen is pressed. If desired, the audible alarm can be disabled in the software's **Maintenance** view (see page 30).

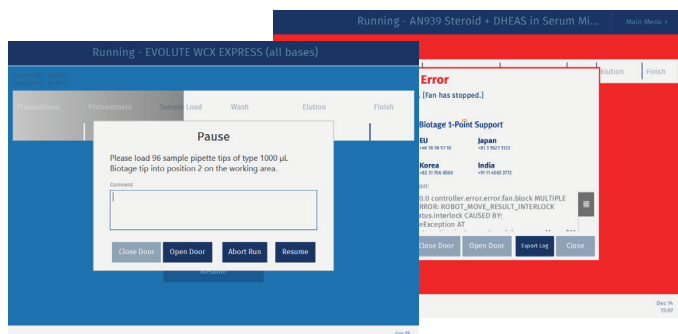

Figure 7. When a non-user-initiated or scheduled pause occurs, the software background flashes in blue. If a system error occurs, the software background flashes in red.

Lighting

To provide better visibility for the user, there are lamps available inside the system. These can be turned on and off in the software's **Maintenance** view (see page 30). There is one control for the upper lamps and one for the lower.

Adjustable Touch Screen

The system is operated through a 12" touch screen that is adjustable for user height, and can be front facing or side facing. There are two ports for connecting USB memory devices on the left side of the touch screen frame.

Barcode and QR Scanner (Optional)

The barcode and QR scanner (sold separately) can be connected to one of the two USB ports on the touch screen frame and be used instead of the touch keyboard to enter information.

Biotage® Extrahera™ GLP Software License (Optional)

With the Extrahera GLP software license, you can combine the utility of the system's advanced lab automation with the organizational features used under Good Laboratory Practices.

Highlighted GLP Features

- » **Manage**
 - » Oversee system control and access with five distinct User Roles.
 - » User roles designed to match lab personnel with their training and expertise.
- » **Secure**
 - » Maintain system and data security.
 - » Incorporated password protection, timed sessions, and restricted USB port access.
- » **Network**
 - » Network integration allows for backup/restore or export of reports and audit trails to your local area network or LIMS system.
 - » Receive e-mail alerts for system pauses or errors and view your runs on your laptop using the remote viewing option.
- » **Audit**
 - » Automatically monitor all system operations with precision tracking.
 - » Generate a clear audit trail documenting all activities, including user credentials and reasons for making any method changes.

Note: This manual mentions the GLP features briefly. For more information and detailed instructions, see the Extrahera GLP User Manual (P/N 417250).

Power Failure

Warning

- » If the system is found with the door closed and the power off, ensure to ventilate the system properly before turning the system back on.

The system has open solvent reservoirs. If the ventilation fails and solvent vapors are not removed, an explosive environment could be generated. If the system is found with the door closed and the power off, you must:

1. Ventilate the system properly by opening the door manually using the T25 Torx screwdriver supplied with the system; see Figure 8. Ensure to take the necessary precautions to avoid exposure to potentially harmful solvents and/or vapors.
2. Remove all solvent reservoirs and remove any spillage before turning the system back on.

We do not recommend that the system is left unattended for an extended period of time when using flammable solvents.



Figure 8. Open the door manually by turning the screw counterclockwise using the T25 Torx screwdriver supplied with the system.

Manage Solvents, Sample Types, Plates, Racks, and Tips

Data Administration



This bell appears in the lower right corner when important information regarding the setup is available. View the information by pressing the bell.

Solvents, sample types, extraction media (including DFE column tips), sample plates, DFE wash and elution plates, and pipette tips can be created, copied, edited, and deleted in the **Data Administration** view. It is also possible to lock a solvent to a specific reservoir in the solvent rack in position **5** on the working area.

Note: The robot is a precision instrument, i.e. it is important that you enter the correct values when setting up solvents, sample types, plates, racks, and tips in the **Data Administration** view (see Figure 9).

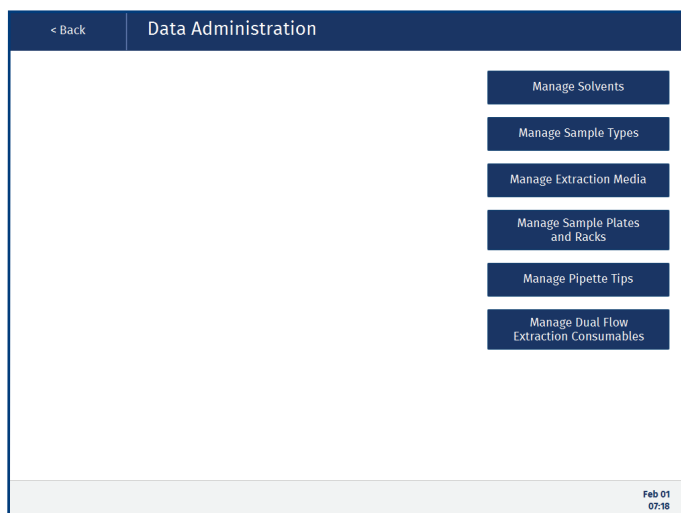

Figure 9. The Data Administration view.

Predefined Entries

The system comes with a number of predefined entries in the **Data Administration** view that cannot be edited or deleted. If desired, these can be copied and edited to your preferences.

Custom Entries

Custom entries cannot be deleted when used in a method or on the system, e.g. when a solvent is locked to a specific solvent reservoir, or when there are dependencies between entries, e.g. a pipette tip cannot be deleted when it is included in a solvent or sample type.

Manage Solvents

To add, copy, edit, view, and delete solvents, and lock a solvent to a specific solvent reservoir, press **Data Administration** in the main menu and then **Manage Solvents** (see Figure 9). The **Manage Solvents** view opens; see Figure 10.

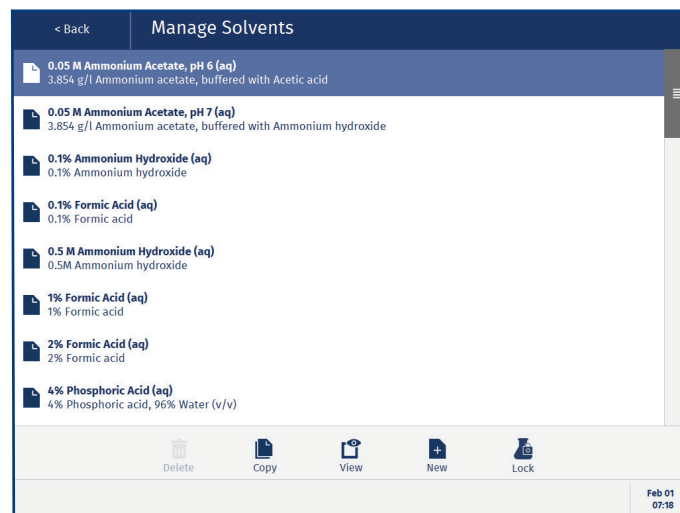

Figure 10. The Manage Solvents view.

Note: Usage of concentrated strong acids (e.g. TFA and TCA) and strong inorganic acids (e.g. nitric, sulfuric, hydrochloric, and perchloric acids) in the solvent pumps is not supported.

General Parameters

The following general parameters are available for solvents (see Figure 11):

- » **Solvent name:** The name that will be displayed in the software.
- » **Solvent description:** The solvent including all additives.
- » **Serial dispensing allowed?:** Whether serial dispensing is allowed (**Yes**) or not (**No**). Note that serial dispensing is faster, while individual dispensing has a higher precision.
- » **Highly volatile?:** Whether the solvent is highly volatile (**Yes**) or not (**No**). When a highly volatile solvent is assigned to the solvent rack in position **5** on the working area, the reservoir is filled just before the solvent is used for the first time in the run. The user will be prompted to ensure that the solvent reservoir is empty before the run is started.
- » **Requires conditioning?:** Whether the pipette tip requires conditioning (**Yes**) or not (**No**).

- » **Conditioning frequency:** How often the pipette tips are conditioned; only before the first aspiration, before each step, or before every aspiration. This field is only enabled when **Requires conditioning** is set to **Yes**.
- » **Conditioning, number of times:** The number of conditioning iterations. This field is only enabled when **Requires conditioning** is set to **Yes**.
- » **Conditioning flow rate (mL/min):** The flow rate that will be used when conditioning the pipette tip. This field is only enabled when **Requires conditioning** is set to **Yes**.
- » **Conditioning volume (% of tip capacity):** The percentage of the pipette tip capacity that will be filled with solvent when conditioning the tip. This field is only enabled when **Requires conditioning** is set to **Yes**.

- » **Aspirate post dispense?:** Whether air is aspirated into the pipette tip after dispensing solvent (**Yes**) or not (**No**).
- » **Aspirate post dispense flow rate (mL/min):** The flow rate that will be used when aspirating post dispense.
- » **Aspirate post dispense volume (µL):** The volume of the post dispense aspiration.
- » **Lower air gap flow rate (mL/min):** The flow rate that will be used when aspirating and dispensing the lower air gap.
- » **Lower air gap volume (µL):** The volume of the lower air gap.
- » **Upper air gap flow rate (mL/min):** The flow rate that will be used when aspirating and dispensing the upper air gap.
- » **Upper air gap volume (µL):** The volume of the upper air gap.
- » **Upper air gap dispense pause (ms):** The amount of time that the system will pause between the solvent dispensation and the upper air gap dispensation. The default value of 300 ms can be adjusted when dealing with viscous, volatile, or low surface tension solvents.

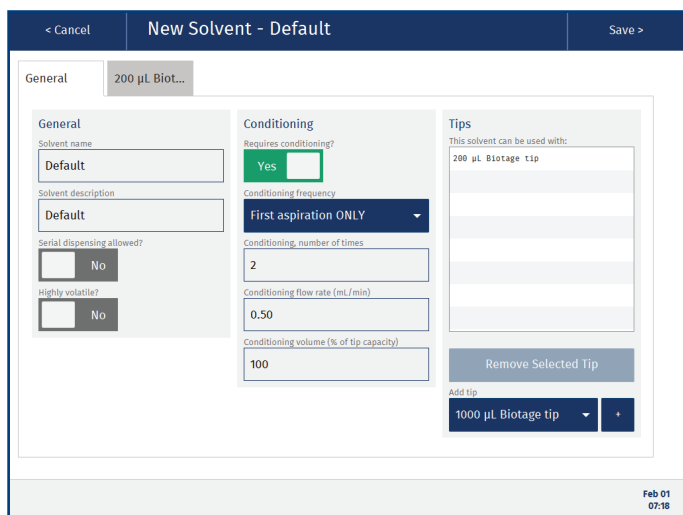
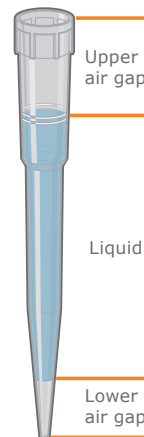

Figure 11. The general solvent parameters and the tips that can be used with the solvent. Add a tip by selecting it from the Add tip drop-down list and pressing the + button.

Tip Parameters

Note: A method cannot be run if it uses a solvent that is missing settings for the used tip.

The system allows you to have individual flow rate, post dispense, and air gap settings for each tip that the solvent will be used with. The predefined solvents include settings for the 50 µL, 200 µL, and 1000 µL pipette tips from Biotage.

To add a tip to a custom solvent, select the tip from the **Add tip** drop-down list at the **General** tab and press the **+** button (see Figure 11).

The following solvent parameters are available for each tip assigned to the solvent (see Figure 12):

- » **Aspiration flow rate (mL/min):** The flow rate that will be used when aspirating the solvent.
- » **Dispense flow rate (mL/min):** The flow rate that will be used when dispensing the solvent.

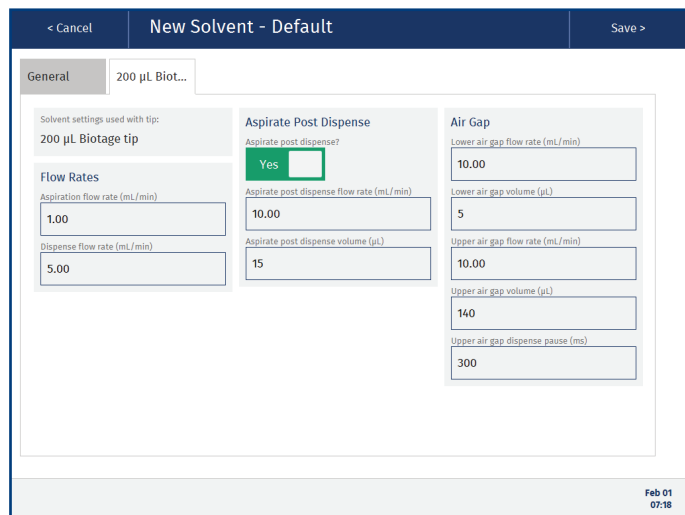

Figure 12. The parameters that can be set up for each tip that is assigned to the solvent.

Lock and Unlock a Solvent

To lock a solvent to a specific solvent reservoir in position **5** on the working area:

1. Press **Lock** in the **Manage Solvents** view (see Figure 10).
2. In the **Lock Solvents to Reservoir Positions** view, select the solvent to be locked from the desired reservoir drop-down list (see Figure 13) and select the corresponding check box.

As long as the solvent is locked to the reservoir, no other solvent can be used in that position. To unlock, clear the check box and press **Save**.

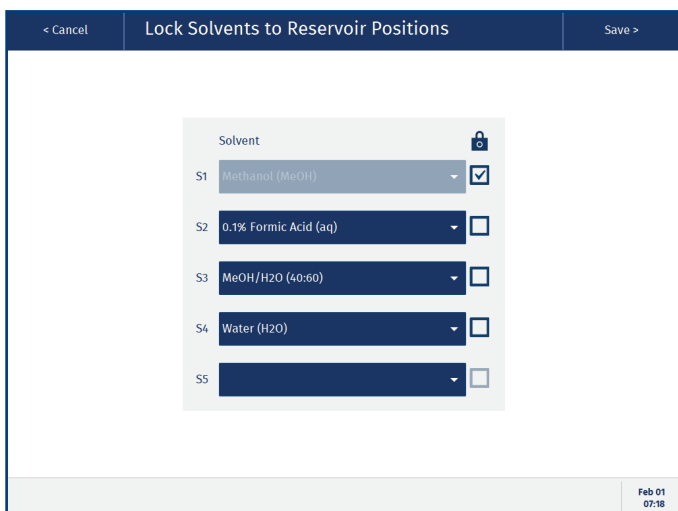

Figure 13. The Lock Solvents to Reservoir Positions view with methanol locked to reservoir S1.

Manage Sample Types

To add, copy, edit, view, and delete sample types, press **Data Administration** in the main menu and then **Manage Sample Types** (see Figure 9 on page 6). The **Manage Sample Types** view opens; see Figure 14. The sample type settings are important if you work with a wide variety of different sample matrices whose liquid handling properties can vary.

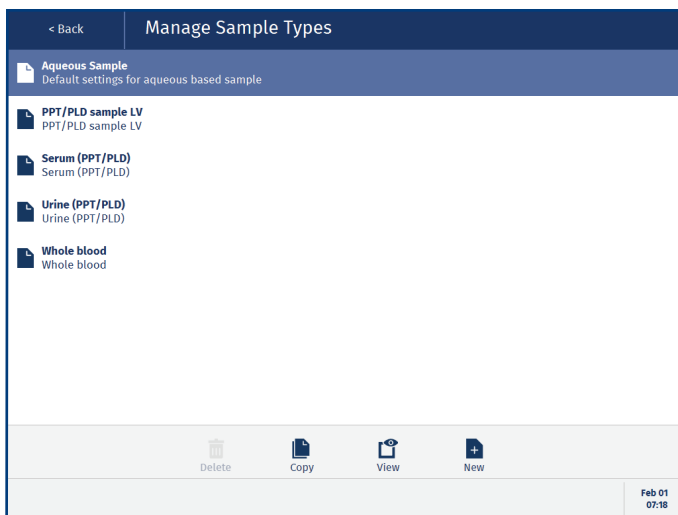

Figure 14. The Manage Sample Types view.

General Parameters

The following general parameters are available for sample types (see Figure 15):

- » **Sample name:** The name that will be displayed in the software.

- » **Sample description:** A description of the sample.

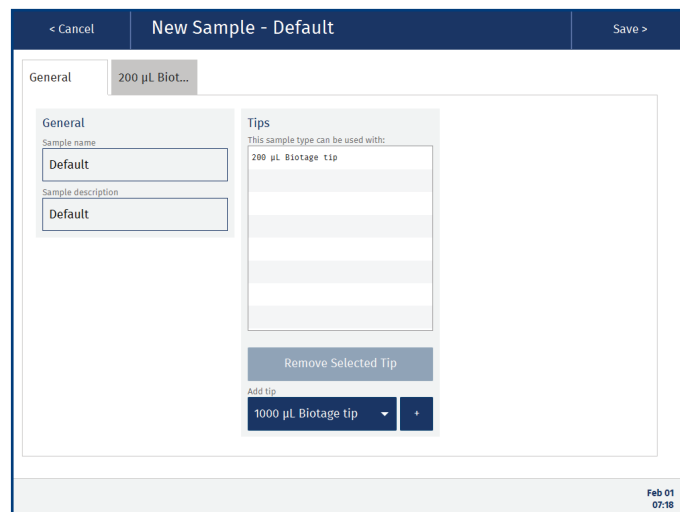

Figure 15. The general sample parameters and the tips that can be used with the sample type. Add a tip by selecting it from the Add tip drop-down list and pressing the + button.

Tip Parameters

Note: A method cannot be run if it uses a solvent that is missing settings for the used tip.

The system allows you to have individual flow rate, post dispense, and air gap settings for each tip that the sample will be used with. The predefined sample types include settings for the 50 µL, 200 µL, and 1000 µL pipette tips from Biotage.

To add a tip to a custom sample type, select the tip from the **Add tip** drop-down list at the **General** tab and press the **+** button (see Figure 15).

The following sample parameters are available for each tip assigned to the sample type (see Figure 16):

- » **Aspiration flow rate (mL/min):** The flow rate that will be used when aspirating samples.
- » **Dispense flow rate (mL/min):** The flow rate that will be used when dispensing samples.
- » **Aspirate post dispense?:** Whether air is aspirated into the pipette tip after dispensing sample (**Yes**) or not (**No**).
- » **Aspirate post dispense flow rate (mL/min):** The flow rate that will be used when aspirating air post dispense.
- » **Aspirate post dispense volume (µL):** The volume of the post dispense aspiration.
- » **Lower air gap flow rate (mL/min):** The flow rate that will be used when aspirating and dispensing the lower air gap.
- » **Lower air gap volume (µL):** The volume of the lower air gap.

- » **Upper air gap flow rate (mL/min):** The flow rate that will be used when aspirating and dispensing the upper air gap.
- » **Upper air gap volume (µL):** The volume of the upper air gap.
- » **Upper air gap dispense pause (ms):** The amount of time that the system will pause between the sample dispensation and the upper air gap dispensation. The default value of 1000 ms can be adjusted when dealing with viscous or pretreated samples that behave differently.

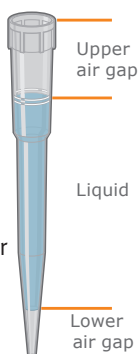

- » **Solvent/Sample dispensation height (mm):** The height where the solvent/sample is dispensed by the pipette tip. See “Tune Pipetting Heights” below.
- » **Aspiration height (mm):** The height where the sample mixture is aspirated by the pipette tip during mixing in the extraction media. See “Tune Pipetting Heights” below.

Figure 16. The parameters that can be set up for each tip that is assigned to the sample type.

Manage Extraction Media

To add, copy, edit, view, and delete extraction plates and column racks, press **Data Administration** in the main menu and then **Manage Extraction Media** (see Figure 9 on page 6).

The following parameters are available for extraction media:

- » **Name:** The extraction plate or column rack name that will be displayed in the software.
- » **Manufacturer:** The manufacturer’s name.
- » **Part number:** The manufacturer’s part number.
- » **Capacity volume (µL):** The amount of liquid that each well or column can accommodate. If the sample load/solvent volume (in the SPE method) exceeds this, the sample/solvent will be dispensed in aliquots, with application of positive pressure in between aliquots. Note that this aliquot feature is disabled when the capacity volume is set to zero, which is the default value.
- » **Format:** The number of wells or columns.
- » **Comment:** Optional information about the plate or column rack.

Figure 17. The Manage Extraction Media view.

Tune Pipetting Heights

The pipetting heights for plates and racks can either be entered manually or set using a wizard (see Figure 18). To open the software wizard, press **Tune Pipetting Heights...** when setting up the new plate or rack. Follow the instructions in the wizard.

Figure 18. Wizard for setting the pipetting heights for plates and racks.

Manage Sample Plates

To add, copy, edit, view, and delete sample plates, press **Data Administration** in the main menu and then **Manage Sample Plates and Racks** (see Figure 9 on page 6).

The following parameters are available for sample plates:

- » **Name:** The sample plate name of the that will be displayed in the software.
- » **Capacity volume (µL):** The maximum amount of liquid that each well or test tube can accommodate. To optimize the Smart Loading feature, see “Smart Sample Loading” below.
- » **Plate/rack height (mm):** The distance between the bottom of the pipette head (when in its highest position) and the top of the plate. This setting is used when the system determines a safe scan height for clog detection (GLP only). For instruction on how to measure the height, see “Measure the Sample Plate Height” below.
- » **Format:** The number of wells .
- » **Aspiration height (mm):** The height where the sample is aspirated and premixed by the pipette tip. See “Tune Pipetting Heights” on page 9. To optimize the Smart Loading feature, see “Smart Sample Loading” below.
- » **Pretreatment dispensation height (mm):** The height where pretreatment solvent is dispensed by the pipette tip. See “Tune Pipetting Heights” on page 9. To optimize the Smart Loading feature, see “Smart Sample Loading” below.

Note: The aspiration and dispensation heights used by the DFE column tip for loading the sample are defined in the method.

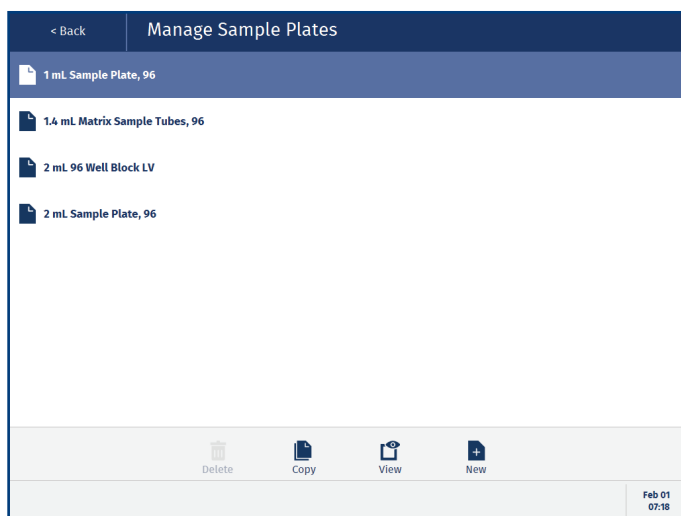

Figure 19. The Manage Sample Plates view.

Smart Sample Loading

The Smart Sample Loading feature allows the pipette tips to move down into the sample plate/rack at a speed that enables the tips to continuously aspirate slightly below the sample surface without aspirating air. When the pipette tips have aspirated the required sample volume or are full, they stop.

When a sample/solvent volume exceeds the specified capacity of the selected extraction plate or columns, the sample/solvent will be dispensed in aliquots, with the option to either reuse the sample pipette tip or use a new sample pipette tip for each aliquot. See “Large Volumes” on page 1.

To get the optimal Smart Sample Loading performance, refer to “Manage Sample Plates” and set up the sample plate according to the following:

1. Set the **Aspiration height** to 1 mm from bottom of the wells/tubes.

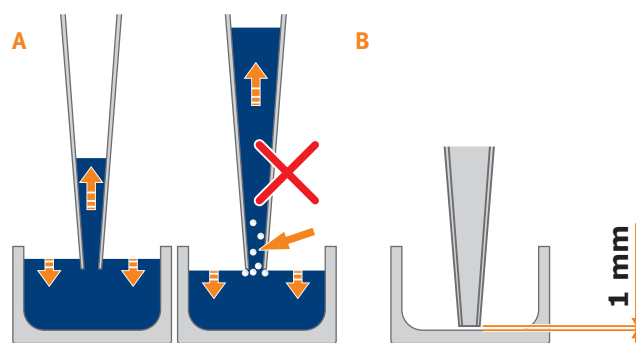

Figure 20. Figure 20a: Use the Smart Sample Loading feature to prevent aspiration of air. Figure 20b: Set the aspiration height.

2. Set the **Pretreatment dispensation height** to approximately 4 mm below the top of the wells/tubes.
3. Set the **Capacity volume** to a value in µL that corresponds to a liquid surface at 5 mm below the top of the wells/tubes.

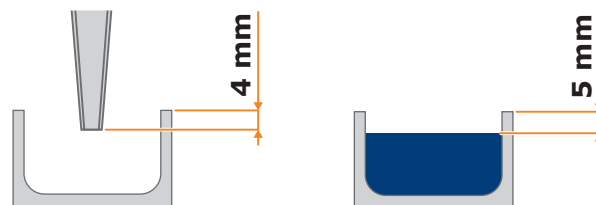

Figure 21. Image 1: Set the Pretreatment dispensation height. Image 2: Set the Capacity volume.

To turn the Smart Sample Loading function off, set the **Capacity volume** to 0 (zero) µL.

Measure the Sample Plate Height

The **Plate height** setting is used when the system determines a safe scan height for clog detection (GLP only).

1. Place the sample plate that you want to measure in position **4** on the working area.
2. Measure the distance from the surface of the working area to the top of the wells/tubes. As a reference, this value is between 36 and 61 mm for the default Biotage sample plates.
3. Set the **Plate height** to the measured value.

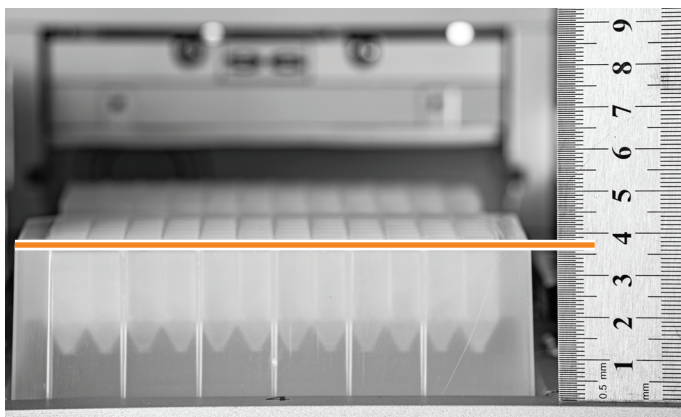

Figure 22. The height for this sample plate is 37 mm.

Manage Pipette Tips

To add, copy, edit, view, and delete pipette tips, press **Data Administration** in the main menu and then **Manage Pipette Tips** (see Figure 9 on page 6).

The following parameters are available for pipette tips:

- » **Name:** The pipette tip name that will be displayed in the software.
- » **Manufacturer:** The manufacturer’s name.
- » **Part number:** The manufacturer’s part number.
- » **Capacity (µL):** The maximum amount of liquid that can be aspirated. This setting ensures that the system cannot attempt to aspirate more liquid into the pipette tip than it can accommodate.
- » **Length (mm):** The length of the pipette tip.

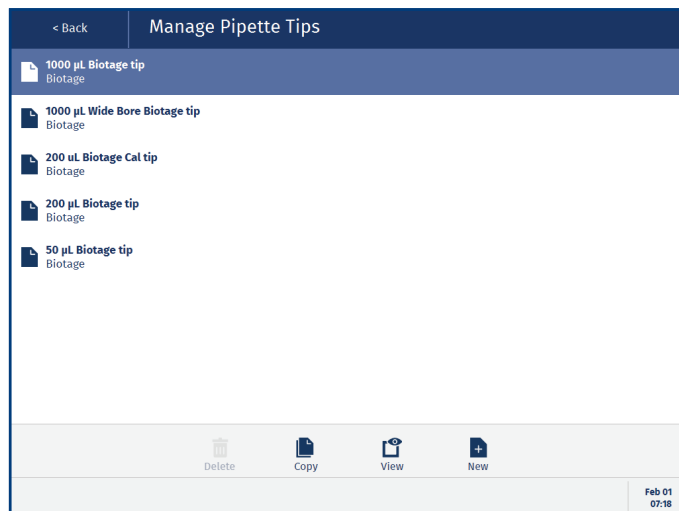

Figure 23. The Manage Pipette Tips view.

Manage Dual Flow Extraction Consumables

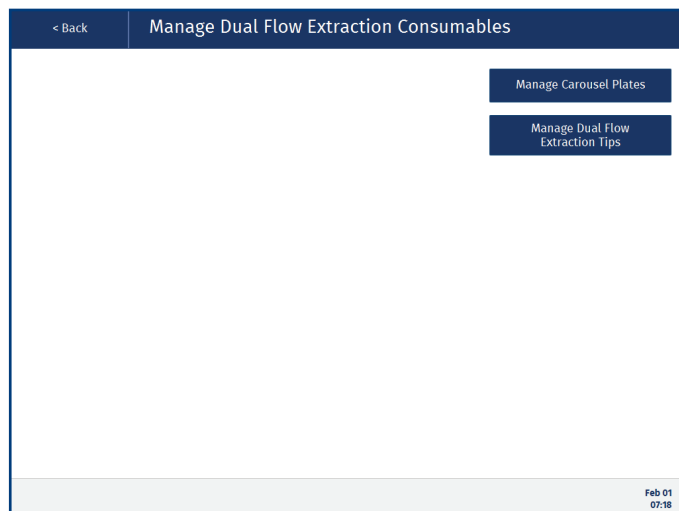

Figure 24. The Manage Dual Flow Extraction Consumables view.

Manage Carousel Plates

To add, copy, edit, view, and delete DFE carousel plates, press **Data Administration** in the main menu and then **Manage Dual Flow Extraction Consumables** (see Figure 9 on page 6) and **Manage Carousel Plates**.

The following parameters are available for DFE carousel plates:

- » **Name:** The wash/elution plate name that will be displayed in the software.
- » **Capacity volume (µL):** The maximum amount of liquid that each well can accommodate.
- » **Plate height (mm):** The height of the plate.
- » **Format:** The number of wells.

- » **Aspiration height (mm):** The height where:
 - » the DFE column tips aspirate during wash, elution, and posttreatment, and
 - » the sample pipette tips aspirate during posttreatment mixing.
- » **Dispensation height (mm):** The height where
 - » the DFE column tips dispense during wash, elution, and posttreatment,
 - » the solvent pipette tips dispense the wash/ elution/posttreatment solvent, and
 - » the sample pipette tips dispense during posttreatment mixing.

Set the aspiration and dispensation heights using the **Tune Pipetting Heights** wizard; see page 9.

Note: When setting up a DFE method, it is possible to set individual aspiration and dispensation heights for each wash and elution step. These will override the aspiration and dispensation heights set for the carousel plate.

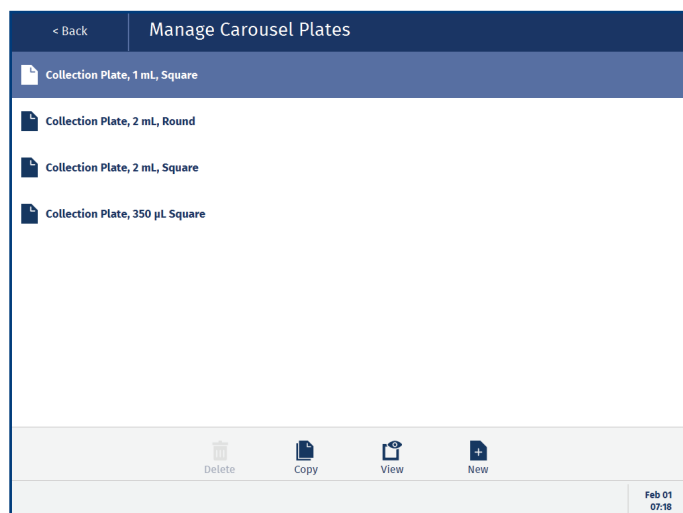

Figure 25. The Manage Carousel Plates view.

Manage Dual Flow Extraction Tips

To add, copy, edit, view, and delete DFE column tips, press **Data Administration** in the main menu and then **Manage Dual Flow Extraction Consumables** (see Figure 9 on page 6) and **Manage Dual Flow Extraction Tips**.

The following parameters are available for DFE column tips:

- » **Name:** The DFE column tip name that will be displayed in the software.
- » **Manufacturer:** The manufacturer's name.
- » **Part number:** The manufacturer's part number.
- » **Capacity (µL):** The maximum amount of liquid that can be aspirated. This setting ensures that the

system cannot attempt to aspirate more liquid into the column tip than it can accommodate.

- » **Length (mm):** The length of the DFE column tip.
- » **Media mass:** The mass of the media used in the DFE column tip.
- » **Format:** The number of positions in the pipette rack.

Figure 26. The New DFE Tip view.

Biotage® Extrahera™ GLP Features

- » Custom entries cannot be edited.
- » Deleting an unused custom entry requires that a reason for deleting and the user password are entered.
- » Locking/unlocking a solvent to a specific solvent reservoir in position **5** on the working area requires that a reason for the action and the user password are entered.
- » All creations and deletions of custom entries in the **Data Administration** view and locking and unlocking of solvents are logged in the Data Administration audit trail.

For more information, see the Extrahera GLP User Manual (P/N 417250).

Set Up a Method

Manage Methods



This bell appears in the lower right corner when important information regarding the method setup is available. View the information by pressing the bell.

Methods can be created, copied, edited, viewed, imported, exported, and deleted in the **Manage Methods** view (see Figure 27).

For instructions on how to import, export, and delete methods, see “Export, Import, and Delete Methods” on page 19.

Predefined Methods

The system comes with a number of predefined Biotage methods that cannot be modified or deleted. If desired, they can be copied and then edited to your preferences.

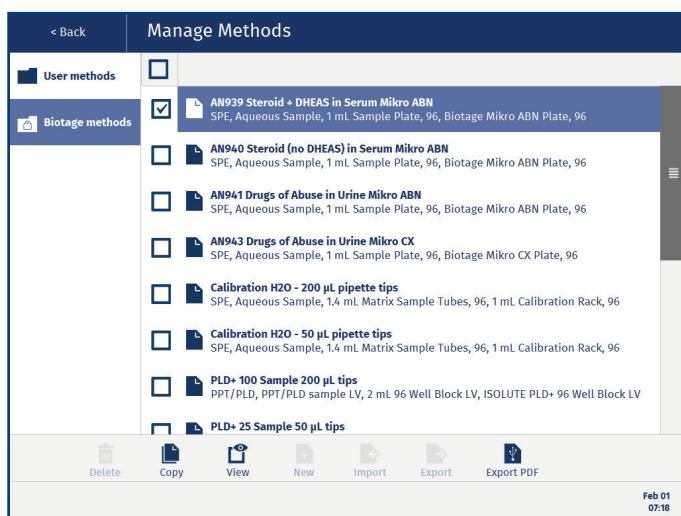

Figure 27. The Manage Methods view.

New, Copy, and Edit a Method

To create a new method, press **Manage Methods** in the main menu, select the **User methods** folder, press **New**, and then select the type of method (see Figure 28):

- » **SLE** (Supported Liquid Extraction)
- » **SPE** (Solid Phase Extraction)
- » **PPT/PLD** (Protein Precipitation/Phospholipid Depletion)
- » **Filtration** (collects filtrate from extraction media that is preloaded with sample)
- » **Filtration+** (sample load and filtration preceded by an optional pretreatment operation)
- » **Hydro DME+** (Dual Mode Extraction)
- » **DFE** (Dual Flow Extraction)

Note: There are two PPT/PLD modes, **Solvent First** or **Sample First**, where the sample is either added before or after the solvent. The mode can be changed in the **Maintenance** view (see page 30). This has to be done before you set up the method.

Note: The pressure unit is not initialized in the Filtration method and disabled in DFE method.

To copy or edit a method, select the folder containing the method, select the method, and then press **Copy** or **Edit** (see Figure 27). Copies are saved in the **User methods** folder.

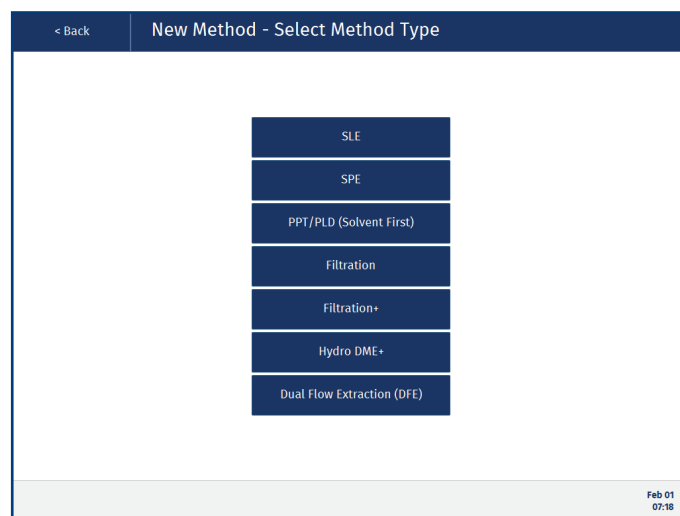

Figure 28. The Select Method Type view.

To save changes in a displayed method, press **Save** in the top pane. To return to the **Manage Methods** view without saving, press **Cancel** in the top pane.

For information on the available method parameters, see the following sections in this chapter.

Exclamation Mark

When setting up a method, the exclamation mark (⚠) shows which information is required to run the method (see Figure 29).

Methods that do not contain all the required information are highlighted with an exclamation mark (⚠) in the **Manage Methods** view (see Figure 30).

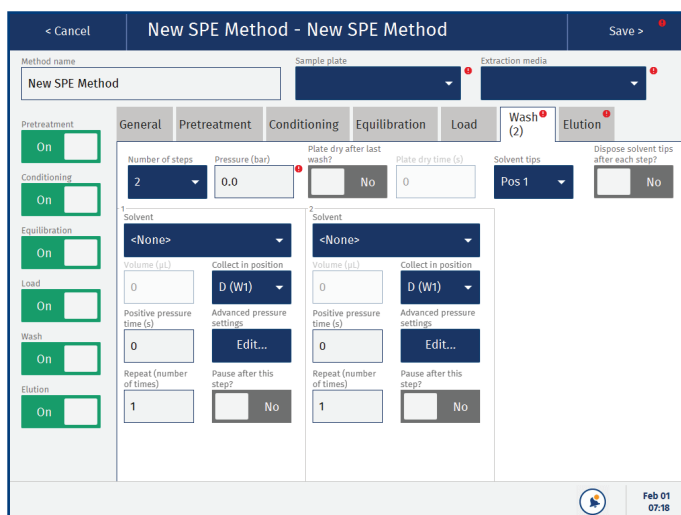

Figure 29. Setting up an SPE method. The exclamation mark (⚠) shows which information is required to run the method. For more information, press ⓘ in the lower right corner.

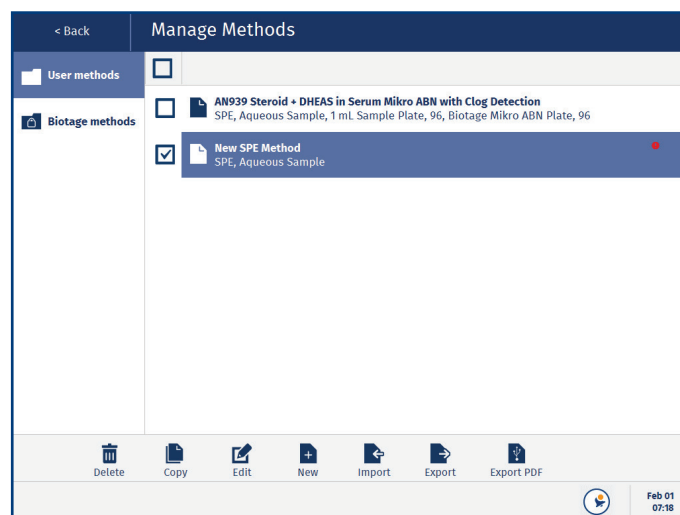

Figure 30. User methods highlighted with ⚠ do not have all the necessary information to be run and are not displayed in the Run view.

Method Operations

The following operations can be enabled or disabled when setting up a method:

Operation	SLE	SPE	PPT/ PLD	Filtration	Filtration+	Hydro DME+	DFE
Pretreatment	✓	✓ ¹			✓	✓	✓
Conditioning		✓					✓
Equilibration		✓					✓
Load/Solvent load	✓ ²	✓ ²	✓ ³		✓ ⁴	✓ ²	✓ ²
Wash		✓					✓
Elution	✓	✓					✓
Posttreatment							✓
Collection			✓	✓	✓	✓	

Table 1. Method operations that can be enabled or disabled.

¹ The pretreatment step can be moved to take place immediately before load.

² Sample load.

³ The sample is either added before or after the solvent depending on a system setting. To change this setting, press **Maintenance** in the main menu and then disable or enable the **Add solvent first** option in the **PPT/PLD Mode** field. This has to be done before you set up the method.

⁴ A load operation is incorporated into the collection operation.

The following operations has the option to use more than one type of solvent tip. In Pretreatment it is possible to assign different tips to the different sub-steps.

Operation	SLE	SPE	PPT/ PLD	Filtration	Filtration+	Hydro DME+	DFE
Pretreatment	✓	✓ ¹					
Conditioning	✓	✓					
Equilibration	✓	✓					
Load/Solvent load							
Wash	✓	✓					
Elution	✓	✓					
Posttreatment							
Collection							

Table 2. Operations that can use more than one tip.

Any combination of 50 µL, 200 µL, 1000 µL, and 1000 µL wide boar tips can be used.

Note: While all tips can be placed in position 1, only 50 µL and 200 µL tips can be placed in position 6. These tips require a special short pipette rack, see more information under Consumables and Accessories page 42.

Method Parameters

Note: For DFE method parameters, see page 17.

Available method parameters are listed in alphabetical order:

- » **Advanced pressure settings:** Press **Edit...** to set up a pressure gradient. For more information, see page 16.
- » **Air push after last elution?:** Whether to apply positive pressure with a gas flow of approximately 10 mL/min after the last elution (**Yes**) or not (**No**). SLE only.
- » **Air push time (s):** The amount of time, in seconds, that positive pressure with a gas flow of approximately 10 mL/min will be applied to the extraction plate or columns to trigger gravity loading or elution. This field is only enabled for elution when **Air push after last elution?** is set to **Yes**. SLE only. Note that this field is disabled when a pressure gradient is enabled; see “Set Up a Pressure Gradient” on page 16.
- » **Clog detection?:** GLP feature. For more information, see the Extrahera GLP User Manual (P/N 417250).
- » **Clog settings:** GLP feature. For more information, see the Extrahera GLP User Manual (P/N 417250).
- » **Collect in position:** In which position the collection platerack or the flow-through plate (waste) is to be loaded onto the carousel.
- » **Collection plate height (%):** How high, in percentage of the maximum height, the collection plate is moved up by the lifter. See Table 3 on page 16 for guidelines. Filtration only.
- » **Conditioning solvent:** The solvent to be used for pipette tip conditioning. SPE only. This field is only visible when **Tip conditioning?** is set to **Yes**.
Note: The solvent must include parameters for the pipette tip it will be used with; see “Manage Solvents” on page 6.
- » **Dispose solvent tips?:** Whether the pipette tips will be disposed of after the solvent load (**Yes**) or reused (**No**). PPT/PLD (solvent first) only.
- » **Dispose solvent tips after each step?:** Whether the pipette tips will be disposed of after each step (**Yes**) or reused (**No**). Note that it is not possible to reuse a pipette tip after sample dispensation. Not available for Filtration and PPT/PLD.
- » **Extraction media:** The type of extraction plate or columns.
- » **Method comment:** Optional information about the method.
- » **Method name:** The name of the method.
- » **Mix number of times:** The number of mixing iterations when mixing the sample with a solvent following pretreatment (except for PPT/PLD). Not available for Filtration.
- » **Mix volume (µL):** The aspiration volume when mixing the sample with a solvent following pretreatment (except for PPT/PLD). Not available for Filtration.
- » **Move pretreatment step:** Use the arrow buttons to move the pretreatment operation to the desired position, before conditioning (default) or before load. SPE only.
- » **Number of steps:** The number of steps the operation contains. Not available for Filtration and PPT/PLD.
- » **Number of times:** The number of mixing iterations in the sample plate. This field is only enabled when **Premix?** is set to **Yes**. Not available for Filtration.
- » **Pause after this step/last step/each load?** Whether to pause after a certain step or operation (**Yes**) or not (**No**). When the system is paused, it is possible to open the door to, for example, check for clogged wells or columns. Not available for Filtration and PPT/PLD.
- » **Plate dry after last elution?:** Whether to remove the last residual solvent from the sorbent bed using positive pressure at 5 bar with a gas flow of approximately 600 mL/min after the last elution (**Yes**) or not (**No**). SPE only.
- » **Plate dry after last wash?:** Whether to remove the last residual solvent from the sorbent bed using positive pressure at 5 bar with a gas flow of approximately 600 mL/min (**Yes**) or not (**No**). SPE only.
- » **Plate dry time (s):** The amount of time, in seconds, that positive pressure at 5 bar with a gas flow of approximately 600 mL/min will be applied to remove the last residual solvent from the sorbent bed. This field is only enabled when **Plate dry after last elution/wash?** is set to **Yes**. SPE only.
- » **Positive pressure time (s):** The amount of time, in seconds, that positive pressure will be applied to the extraction plate or columns. Not available for SLE. Note that this field is disabled when a pressure gradient is enabled; see “Set Up a Pressure Gradient” on page 16.
- » **Premix?:** Whether the sample will be premixed (**Yes**) or not (**No**) before it is loaded into the extraction plate or columns. Not available for Filtration.
- » **Pressure (bar):** The pressure, in bar, that will be applied to the extraction plate or columns. Not available for SLE. Note that this setting will not be used when a pressure gradient is enabled; see “Set Up a Pressure Gradient” on page 16.
- » **Repeat (number of times):** The number of times this step will be repeated. SPE and SLE only.
- » **Reuse tips for pretreatment mix and sample load?:** Whether to reuse a sample pipette tip when mixing following pretreatment, when loading a sample in aliquots, or when rinsing the wells/tubes in the sample plate (**Yes**) or not (**No**). Not available for Filtration, PPT/PLD, and Hydro DME+.
- » **Rinse repeat number of times:** The number of rinsing iterations in the sample plate. This field is only enabled when **Premix?** is set to **Yes**. SPE only. This field is only visible when **Rinsing?** is set to **Yes**.
- » **Rinse solvent:** The solvent to be used to rinse the wells/tubes in the sample plate. SPE only. This field is only visible when **Rinsing?** is set to **Yes**.
Note: The solvent must include parameters for the pipette tip it will be used with; see “Manage Solvents” on page 6.

- » **Rinse volume (μL):** The amount of rinsing solvent to be used for each well/tube in the sample plate. SPE only. This field is only visible when **Rinsing?** is set to **Yes**.
- » **Rinsing?:** Whether to remove the last residual sample from the sample plate by rinsing the wells/tubes with solvent, and then transferring the liquid to the extraction media (**Yes**) or not (**No**). SPE only.
- » **Sample pipette tip type:** The type of pipette tips to be used when loading and mixing the sample. Not available for Filtration.
- » **Sample plate/rack:** The type of sample plate or tubes. Not available for Filtration.
- » **Sample type:** The type of sample. This setting is important if you work with a wide variety of different sample matrices whose liquid handling properties can vary.
- » **Sample volume (μL):** The amount of sample to be used for each well or column in the extraction plate/rack. If the volume exceeds the specified capacity of the selected extraction plate or columns, the sample will be dispensed in aliquots, with application of positive pressure in between each aliquot. Not available for Filtration.

Note: If the capacity of the selected extraction plate or columns is set to zero, which is the default value, the system will still dispense the requested sample volume.

Note: When loading a sample in aliquots, the sample pipette tip can be reused. See Reuse tips for pretreatment mix and sample load above.

- » **Solvent:** The solvent to be used for this step. Not available for Filtration.
- Note:** The solvent must include parameters for the pipette tip(s) it will be used with; see “Manage Solvents” on page 6.
- » **Solvent tips:** The tip to be used in a specific step. When position 6 is used for additional tips it is possible to choose tips from either position 1 or position 6 for each step.
- » **Starting sample volume in plate/rack (μL):** The amount of available liquid in each well/tube in the sample plate, prior to starting the method.
- » **Tip conditioning?:** Whether to condition the pipette tip with a solvent (**Yes**) or not (**No**). SPE only.
- » **Volume (μL):** The amount of solvent to be used. Not available for Filtration.
- » **Wait time (min):** The amount of time to wait to complete the process step.

Set Up a Pressure Gradient

When setting up an SPE method, it is possible to create a pressure gradient for any conditioning, equilibration, load, wash, or elution step. Pressure gradients are also available for load and elution steps in SLE methods, and for the collection step in PPT/PLD, Filtration, Filtration+, and Hydro

DME+ methods. To set up a pressure gradient, press the **Edit...** button for the desired step (see Figure 31).

The following pressure gradient parameters are available (see Figure 31):

- » **Use advanced pressure settings?** Whether to use a pressure gradient (**Yes**) or not (**No**).
- » **Number of steps:** The number of steps the pressure gradient contains.
- » **Pressure (bar):** The pressure, in bar, that will be applied to the extraction plate or columns.
- » **Positive pressure time (s):** The amount of time, in seconds, that positive pressure will be applied to the extraction plate or columns.
- » **Air push/Plate dry:** Whether to apply positive pressure with a gas flow of approximately 10 mL/min (air push) or 600 mL/min at 5 bar (plate dry) after the pressure gradient has been completed (**Yes**) or not (**No**).
- » **Air push time/Plate dry time (s):** The amount of time, in seconds, that positive pressure will be applied to remove the last residual solvent from the sorbent bed. This field is only enabled when **Air push/Plate dry?** is set to **Yes**.

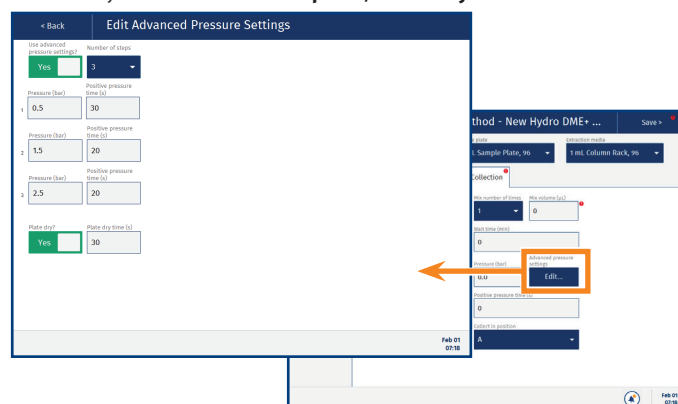

Figure 31. In the Edit Advanced Pressure Settings view, you can set up a pressure gradient for a conditioning, equilibration, sample load, wash, collection, or elution step.

Specify the Collection Plate Height (Filtration Only)

When setting up a Filtration method, you need to specify how high the collection plate is to be moved up by the lifter toward the extraction media. The height is specified in percentage of the maximum height. The table below lists the approximate settings for the **Collection plate height (%)** parameter for some combinations of collection plate and extraction media.

Collection Plate	Extraction Media	Height (%)
1/2 mL Collection Plate, 96	Extraction Plate, 96	90
1/2 mL Collection Plate, 96	1 mL Array Plate, 96	73
1/2 mL Collection Plate, 96	1 mL Column Rack, 96	73

Table 3. Examples of settings for the Collection plate height (%) parameter that is used in the Filtration method.

DFE Method Parameters

Available DFE method parameters are listed in alphabetical order:

- » **Aspiration flow rate (mL/min):** The flow rate to be used when aspirating liquid. When aspirating solvent, this setting overrides the flow rate defined for the solvent. For residual purge, see page 18.
- » **Aspiration height (mm):** The height used when aspirating from the sample plate using the DFE column tip. Press **Tune Pipetting Heights...** to set the height using a wizard; see Figure 32. For aspiration height in residual purge, see page 18.
- » **Cycle volume (µL):** The amount of liquid to be used for each cycle. For residual purge, see page 18.
- » **DFE tips:** The type of dual flow chromatography column tip to be used.
- » **Dispensation flow rate (mL/min):** The flow rate to be used when dispensing liquid. When dispensing solvent, this setting overrides the flow rate defined for the solvent. For residual purge, see page 18.
- » **Dispensation height (mm):** The height used when dispensing into the sample plate using the DFE column tip. Press **Tune Pipetting Heights...** to set the height using a wizard; see Figure 32. For dispensation height in residual purge, see page 18.
- » **Dispose solvent tips?:** Whether the pipette tips will be disposed of after dispensing the posttreatment solvent into the elution plate (**Yes**) or reused (**No**).
- » **Fill volume (µL):** The amount of solvent filled into the wash/elution plate on the carousel. The plates can be filled manually or by the system; see the **Filled by system?** setting in the method's **Carousel** tab.
- » **Filled by system?:** Whether the wash/elution solvent is loaded into the carousel plate by the user before the run is started or by the system. The system can either load the solvent in the method's preparation phase (**Yes, before method**) or straight before the wash/elution step is to be performed (**Yes, before step**). Note that the latter option requires that the DFE column tips are temporarily returned to the DFE rack in position **6**.
- » **Hold time after aspiration/dispensation (seconds):** The amount of time that the system will pause after each aspiration/dispensation.
- » **Last dispense position:** In which position the last dispensation in the step is to be performed, in the solvent reservoir or the waste position on the carousel.
- » **Method comment:** Optional information about the method.
- » **Method name:** The name of the method.
- » **Mix?:** Whether the sample/eluate is mixed (**Yes**) or not (**No**) with the pretreatment/posttreatment solvent.
- » **Mix aspiration/dispensation height (mm):** The height used for aspiration/dispensation when mixing the sample/eluate with the pretreatment/posttreatment solvent. Press **Tune Pipetting Heights...** to set the heights using a wizard; see Figure 32.
- » **Mix number of times:** The number of mixing iterations when mixing the sample/eluate with the pretreatment/posttreatment solvent. This field is only available when **Mix?** is set to **Yes**.
- » **Mix volume (µL):** The aspiration volume when mixing the sample/eluate with the pretreatment/posttreatment solvent. This field is only available when **Mix?** is set to **Yes**.
- » **Number of cycles:** The number of aspirate-hold-dispense-hold cycles.
- » **Number of steps:** The number of steps the operation contains.
- » **Pause after last cycle/step?:** Whether to pause after a certain step or operation (**Yes**) or not (**No**). When the system is paused, it is possible to open the door.
- » **Plate/rack:** The type of plate to be used in the carousel position.
- » **Purge settings:** See “DFE Method Parameters” on page 17.
- » **Residual purge:** See “DFE Method Parameters” on page 17.
- » **Sample mix tip type:** The type of pipette tip to be used when mixing sample/eluate with the pretreatment/posttreatment solvent.
- » **Sample plate/rack:** The type of sample plate or tubes.
- » **Solvent:** The solvent to be used for this step. **Note:** The solvent must include parameters for the tip(s) it will be used with (including the DFE column tip, if applicable); see “Manage Solvents” on page 6.
- » **Solvent dispensation height (mm):** The height used when dispensing the posttreatment solvent into the (last) elution plate. If there is no elution step, the system will dispense into the (last) wash plate. Press **Tune Dispensation Height...** to set the height using a wizard; see Figure 32.
- » **Starting sample volume in plate/rack (µL):** The amount of available liquid in each well/tube in the sample plate, prior to starting the method.
- » **Upper air gap volume, DFE tip (µL):** The volume of the upper air gap to be used with the specified DFE column tip. The air gap is aspirated before the DFE column tip is picked up. For residual purge, see page 18.
- » **Used for:** What the carousel position is to be used for; wash, elution, or waste.
- » **Volume (µL):** The amount of solvent to be used.
- » **Wait time (min):** The amount of time to wait to complete the pretreatment/posttreatment operation.

Tune Pipetting Heights

Use the **Tune Pipetting Heights** wizard (see Figure 32) to:

- » Set the height for aspiration and dispensation in the sample plate using the DFE column tips. Open the wizard by pressing **Tune Pipetting Heights...** at the **Load** tab.
- » Set the heights for aspiration and dispensation during a residual purge. Open the wizard by pressing **Edit...** at the **Sample/Wash/Elution** tab and then **Tune Pipetting Heights....**
- » Set the height used when dispensing the posttreatment solvent into the (last) elution plate using solvent tips. Open the wizard by pressing **Tune Dispensation Height...** at the **Posttreatment** tab.
- » Set the height for aspiration and dispensation when mixing the sample/eluate with the pretreatment/posttreatment solvent. Open the wizard by pressing **Tune Pipetting Heights...** at the **Posttreatment** tab.

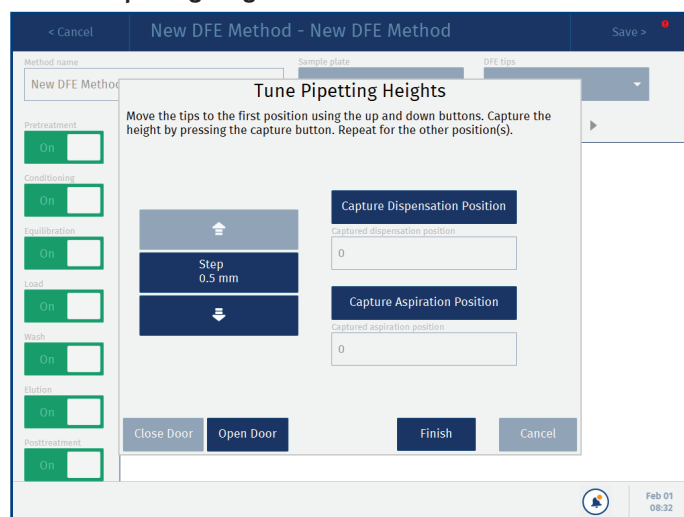

Figure 32. Wizard for setting pipetting heights.

Set Up a Residual Purge

The residual purge option allows all residual sample, wash, and/or elution solvents to be pushed out of the DFE column tips. This ensures that the tips are primed for the next step and that the risk of cross contamination is minimized.

When setting up a DFE method, it is possible to add a residual purge in any load, wash, or elution step. The following parameters are available:

- » **Aspiration flow rate (mL/min):** The flow rate to be used when aspirating air into the DFE column tip.
- » **Aspiration height (mm):** The height used when aspirating air into the DFE column tip, when positioned above the sample/wash/elution plate. Press **Tune Pipetting Heights...** to set the height using a wizard; see Figure 32.
- » **Cycle volume (µL):** The aspiration and dispensation volume used for each purge cycle.

- » **Dispensation flow rate (mL/min):** The flow rate to be used when emptying the DFE column tip.
- » **Dispensation height (mm):** The height used when emptying the DFE column tip into the sample/wash/elution plate. Press **Tune Pipetting Heights...** to set the height using a wizard; see Figure 32.
- » **Dispensation position:** Where the DFE column tip is emptied; in the sample/wash/elution plate or in the waste position in the carousel. **Number of cycles:** The number of purge iterations in the sample, wash, or elution operation.
- » **Upper air gap flow rate (mL/min):** The flow rate to be used when aspirating the upper air gap.
- » **Upper air gap volume (µL):** The volume of the upper air gap that is to be used to push out residual liquid from the DFE tip. This is performed after the last cycle of the residual purge step.

Note: The combined volume of upper air gap that is used for all residual purges that are enabled in the method cannot be greater than the **Upper air gap volume, DFE tip** set at the **Sample** tab. A warning will be triggered if it is.

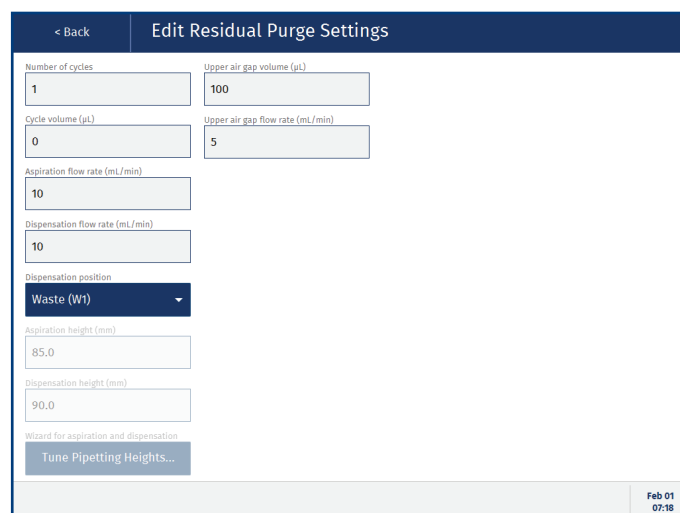

Figure 33. The Edit Residual Purge Settings view.

Biotage® Extrahera™ GLP Features

- » All methods contain a timestamp that shows when the method was last changed and by whom. More details can be found in the method audit trail.
- » Clog detection can be enabled for any load, wash, and elute step in SPE, SLE, and Filtration+ methods.
- » The contents of the report are set up in the method. It is also possible to let the operator add a comment to the report just before the report is generated by enabling the **End of run comment** option.
- » Methods that contain all information required to be run can be locked. The method is then moved to the **Locked methods** folder and cannot be modified or deleted. It can be unlocked by the same user.

For more information, see the Extrahera GLP User Manual (P/N 417250).

Export, Import, and Delete Methods

Manage Methods

For instructions on how to set up a method, see “Set Up a Method” on page 13.

Export Methods

To export method(s) for backup or to be used on another Extrahera system:

1. Connect a USB memory device to one of the USB ports on the touch screen frame.
2. Press **Manage Methods** in the main menu.
3. Select the method(s) that you want to export and press **Export**. To select all the methods in the folder, select the check box in the header.
Note: It is only possible to export the predefined Biotage methods as PDF file(s).
4. When the export is completed, press **Close** in the **Exporting Method(s)** dialog.

To export the selected method(s) as PDF file(s) instead, press **Export PDF**. Exported methods are saved in a **methods** folder.

Import Methods

1. Connect a USB memory device to one of the USB ports on the touch screen frame.
2. Press **Manage Methods** in the main menu.
3. Select the **User methods** folder and press **Import**.
4. In the **Select the File to Import** dialog, browse to the file location (if necessary), select the file, and press **Import**.
5. In the **Confirm Import** dialog, press **Yes**.
6. When the import is completed, press **Close** in the **Importing Method(s)** dialog.

If you import a method containing a solvent, pipette tip, plate, or rack that is not available on the system, it will also be imported. The decision is based on the name of the solvent, pipette tip, plate and rack, and will not consider their settings.

Delete Methods

Delete one or more methods by selecting the method(s) and pressing **Delete**. Note that all methods in the folder will be deleted if you select the check box in the header.

Biotage® Extrahera™ GLP Features

- » Methods can be exported to a USB memory device and/or a network share folder depending on which export destinations that are available/allowed on the system.
- » Methods can be imported from a USB memory device and/or a network share folder (if available).
- » Only one method at a time can be deleted. The user has to enter a reason for deleting and the user password.
- » All import, export, and delete actions performed on the system are logged in a master audit trail.

For more information, see the Extrahera GLP User Manual (P/N 417250).

Set Up and Start a Run

Run Method/Run Individual Samples

Warning

- » All samples and waste should be treated as potentially biohazardous.



This bell appears in the lower right corner when important information regarding the run setup is available. View the information by pressing the bell.

Verify the System Setup

Verify the following before operating the system:

1. Ensure that all connections are properly connected and tightened; see the “Connections” section in the Installation and Safety document supplied with the system.
2. Ensure that the extraction waste collector is in place; see F in Figure 58 on page 31.
3. Ensure that the vacuum is turned on and that there is sufficient volume in the waste reservoir.
4. If using a vacuum pump, ensure that the vacuum pump fumes are directed into a proper ventilation system.
5. Ensure that the pipette tip waste bin (below the **WASTE** position on the working area) is empty.
6. Ensure that there is a solvent rack, with reservoirs in all five rack positions, in position **5** on the working area and that the solvent feeder is in position (see Figure 34). The solvent feeder is orange in the **Prepare Run** view when it is not in position.
7. Ensure that the plate/rack frame is removed/installed and the DFE mode option is enabled/disabled according to what is required for your method; see instructions in “Enable/Disable the DFE Mode” on page 29.



Figure 34. The solvent feeder in position to deliver solvent to the five reservoirs in position 5 on the working area.

Select the Method

8. In the main menu, press **Run Method** or **Run Individual Samples**. When running individual samples, a maximum of 7 samples can be processed.

9. In the **Run – Select Method** view, select the method to run and press **Prepare Run**. Only methods relevant to the current system configuration (see step 7 above) are displayed.

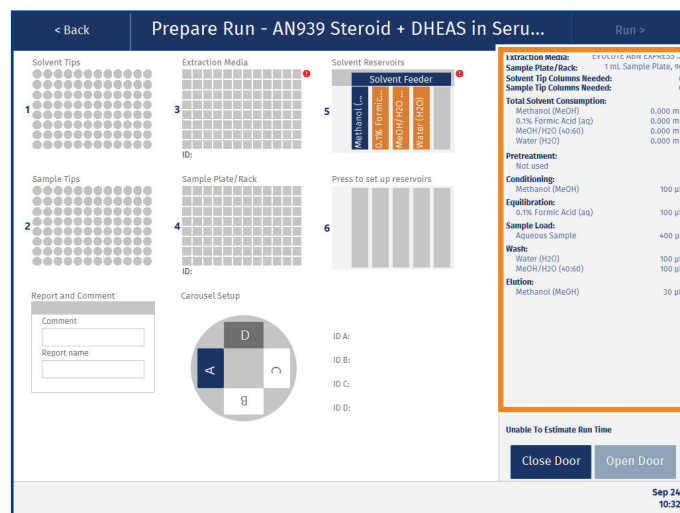

Figure 35. The run checklist in the Prepare Run view. The information is updated when the setup is changed.

Load the Extraction Media

Load Extraction Media for SPE, SLE, PPT/PLD, Filtration, Filtration +, or Hydro DME+

10. Load an extraction plate or column rack into position **3** on the working area. Ensure that the correct type of plate/rack is used; see the run checklist in the **Prepare Run** view (see Figure 35).
11. If using an array plate or column rack with empty positions:
 - » Load the wells or columns symmetrically from the outside in so that the pressure head can be positioned horizontally over the plate/rack; see Figure 36.
 - » Load wells or columns in all positions in a plate/rack column, regardless of whether they are being used or not.

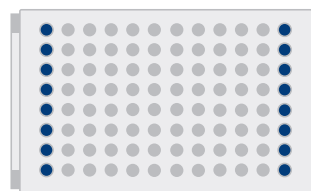

Figure 36. Load the wells/columns symmetrically from the outside in and use all positions in a plate/rack column.

Load Extraction Media for DFE

- Load the DFE column tips into a pipette rack. Ensure that the correct type of DFE column tip is used; see the run checklist in the **Prepare Run** view (see Figure 35 on page 20).
- Load the pipette rack into position **6** on the working area.

Set Up the Extraction Media in the Software and Enter the Plate/Rack ID

- Press the illustration of the extraction plate or column rack in the **Prepare Run** view (position **3** or **6**) and set up the plate/rack:
 - If you selected **Run Method** in step 8, select the plate/rack columns to be used in the **Select Columns/Set Up DFE Tips** view (see Figure 37B). To use all columns, enable the **Use all columns** option.
 - If you selected **Run Individual Samples** in step 8, the samples must be loaded in the first plate/rack column. Select the wells/columns to be used in the **Select Positions/Set Up DFE Tips** view (see Figure 37A).
 - If desired, enter the extraction plate/rack ID in the **Plate ID** text box.
 - When done, press **Save** in the top pane.

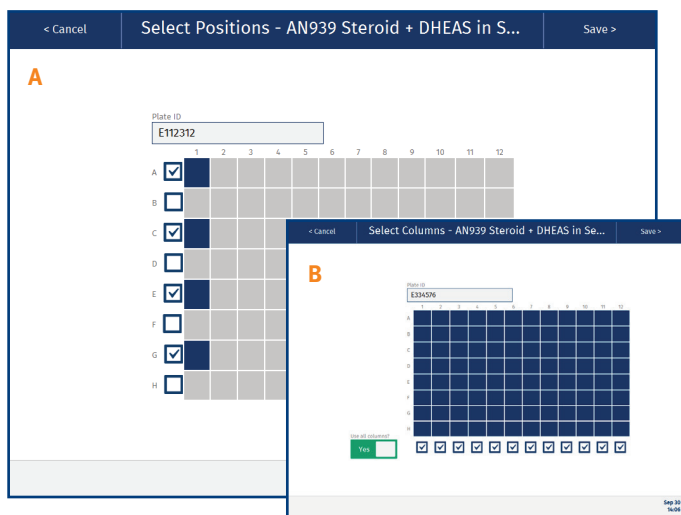

Figure 37. The Select Positions view when running individual samples (A) and the Select Columns view when running the whole plate (B).

Adjust the Air Pressure

- Adjust the pressure of the gas connected to the **AIR** port using the external pressure regulator. The gas connected to the **AIR** port is used to seal the plate or columns and its pressure has to be adjusted according to how many positions in the plate/rack that are populated:
 - » Use 6 ± 0.2 bar (0.6 ± 0.02 MPa; 87 ± 3 psi) for a fully populated extraction plate/rack.
 - » Use approximately 4 bar (0.4 MPa; 58 psi) when 50% of the extraction plate/rack is populated.
 - » Use 3 bar (0.3 MPa; 44 psi) when 25% of the extraction plate/rack is populated.



Note: The pressure unit is not used in dual flow chromatography.

Note: The pressure of the gas connected to the **N₂** port always has to be 6 ± 0.2 bar (0.6 ± 0.02 MPa; 87 ± 3 psi).



Load Solvent Pipette Tips

- Press the illustration of the solvent pipette tips in the **Prepare Run** view (position **1**) and ensure that the **Set Up Solvent Tips** view (see Figure 38) corresponds to the physical pipette rack in position **1** on the working area.

The required number of pipette tips is displayed in the **Set Up Solvent Tips** view. The number of tips reflects the number of solvents used in the method. Ensure that the correct tip type is selected in the **Pipette tip type** drop-down list.

-  Pipette tip available. (If green/red, see below.)
-  No pipette tip available. (If blue border, see below.)

Reuse of Solvent Pipette Tips

-  Pipette tip available for reuse with the solvent listed below the tips; see Figure 38.
-  Pipette tip available for reuse but will not be used in this run (wrong solvent); see Figure 38.
-  Removed pipette tip due to a previous run of individual samples; see Figure 39. Reinsert these to reuse the tips in this column.

If pipette tips from a previous run are not to be reused, remove them and clear the check box for the column(s).

Note: If a column that contains removed tips is not cleared (see Figure 39), pressing **Save** is considered a confirmation that they have been reinserted.

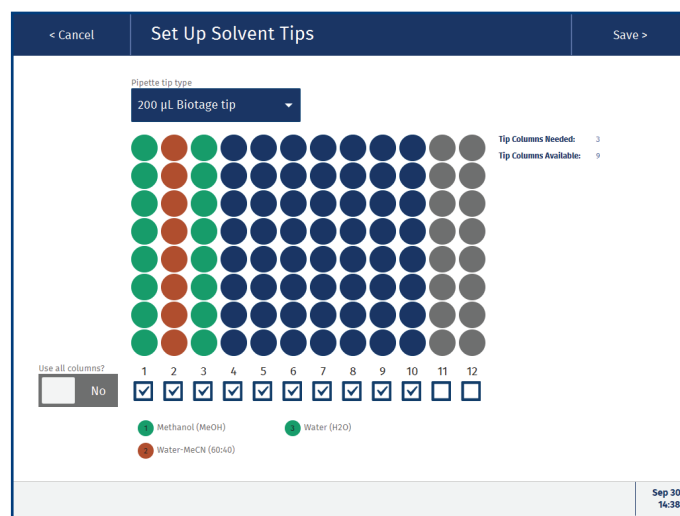

Figure 38. The Set Up Solvent Tips view.

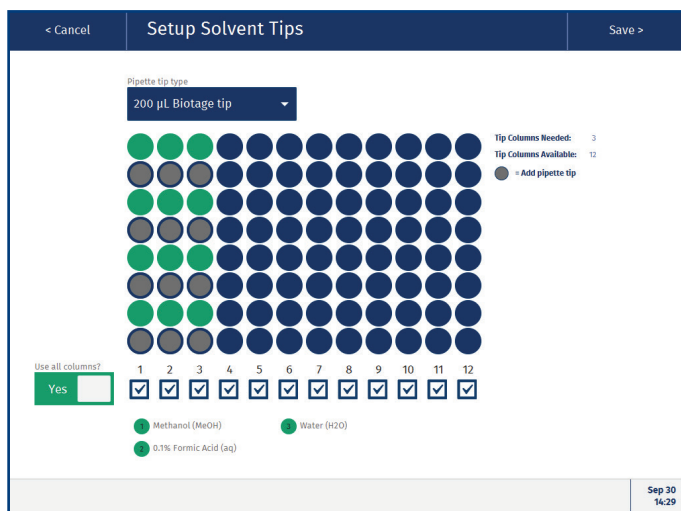





Figure 39. When setting up a run after a run of individual samples, the software highlights the positions that have to be refilled (grey circle with blue border) to reuse the pipette tips in the previous run.

Solvent Pipette Tips for Individual Samples

If running individual samples, it is important that the pipette tips are loaded correctly. The software highlights the positions that must contain pipette tips and the ones that must be empty; see Figure 40.

-  Pipette tip available but will not be used.
-  This pipette tip will be used. If green, it is reused from the previous run for the solvent listed below the tips; see Figure 40.
-  Remove this pipette tip.

15. When done, press **Save** in the top pane to confirm the setup.

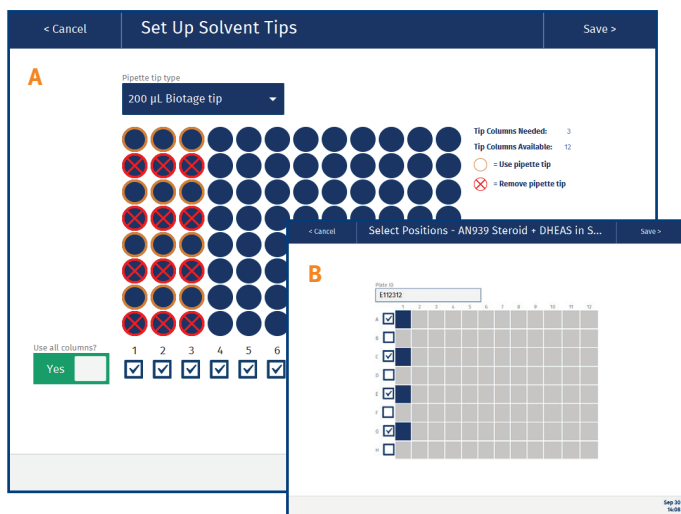

Figure 40. The Set Up Solvent Tips view (A) when running individual samples in position A1, C3, E5, and G1 on the extraction media (B).

Load Sample Pipette Tips



16. Press the illustration of the sample pipette tips in the **Prepare Run** view (position 2) and ensure that the **Set Up Sample Tips** view (see Figure 41) corresponds to the physical pipette rack in position 2 on the working area.

The required number of tips is displayed in the **Set Up Sample Tips** view. If the run requires more than the available quantity of sample pipette tips, the system will automatically pause when it runs out of tips and prompt the user to load more.

The sample pipette tip type is defined in the method. If the wrong tip type is selected in the **Pipette tip type** drop-down list, the software will notify you and the run cannot be started.

Sample Pipette Tips for Individual Samples

If running individual samples, it is important that the pipette tips are loaded correctly. The software highlights the positions that must contain pipette tips and the ones that must be empty; see Figure 41A.

-  Pipette tip available but will not be used.
-  This pipette tip will be used.
-  Remove this pipette tip.

17. When done, press **Save** in the top pane to confirm the setup.

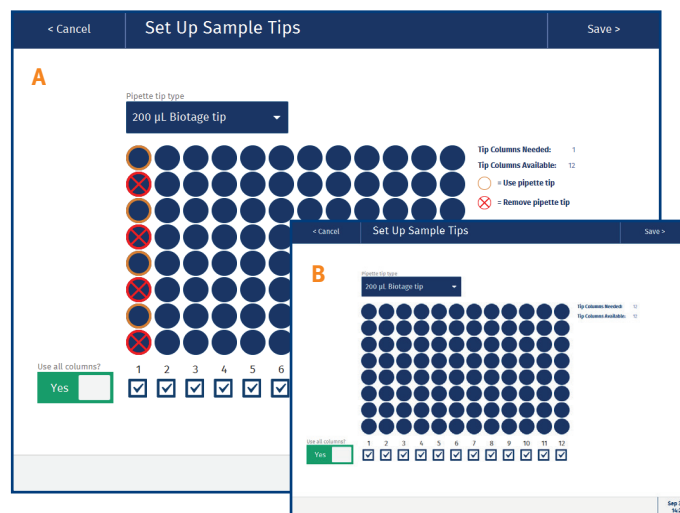

Figure 41. The Set Up Sample Tips view when running individual samples (A) and when running whole plate/rack columns (B).

Assign Solvent Bottles and Prime

Note: Each reservoir has a dead volume of 4 mL to prevent the system from aspirating air.

Note: When a solvent defined as highly volatile (see page 6) is assigned to a solvent reservoir in position **5**, that reservoir is filled just before the solvent is used for the first time in the run.

18. Ensure that the solvent bottles (S1-S5) contain the necessary amount of the solvents needed for the run; see **Total Solvent Consumption** in the run checklist in the **Prepare Run** view (see Figure 35 on page 20).

When any of the solvents used on the system has to be exchanged, the miscibility of the solvent presently connected and the new solvent to be connected is important and has to be considered. The use of a miscible co-solvent is advised and will minimize the time taken for successful priming and therefore the volume of solvent wasted during multiple prime occurrences.

Ensure that no foreign matter (e.g. molecular sieve) is present in the bottles. If necessary, filter the liquids. Use appropriate caps on the bottles to prevent harmful solvent vapors from escaping and the contents from being spilled. Always place the bottles on the side of the system.

19. Press the illustration of the solvent reservoirs in the **Prepare Run** view (position **5**) and ensure that the solvent bottles (S1-S5) are assigned correctly in the **Assign Solvents** view (Figure 42). If necessary, change by using the drop-down lists.
20. If a solvent reservoir is orange in the **Assign Solvents** view (see Figure 42), prime the solvent inlet line:
- Ensure that the solvent reservoir (in position **5** on the working area) is empty. If not, replace it with a new one.
 - Press **Prime....**
 - In the **Prime** view (see Figure 43), enter the prime volume and press **Prime**. Approximately 2-3 times 15 mL is required to fill the solvent inlet line and pump with the new solvent.
- Note:** The reservoir can contain a maximum of 25 mL.
- Ensure that no air bubbles are visible in the tubing. If necessary, empty the solvent reservoir and prime again.
 - When you have finished priming, press **OK** in the top pane and repeat the procedure for any other inlet that needs to be primed.

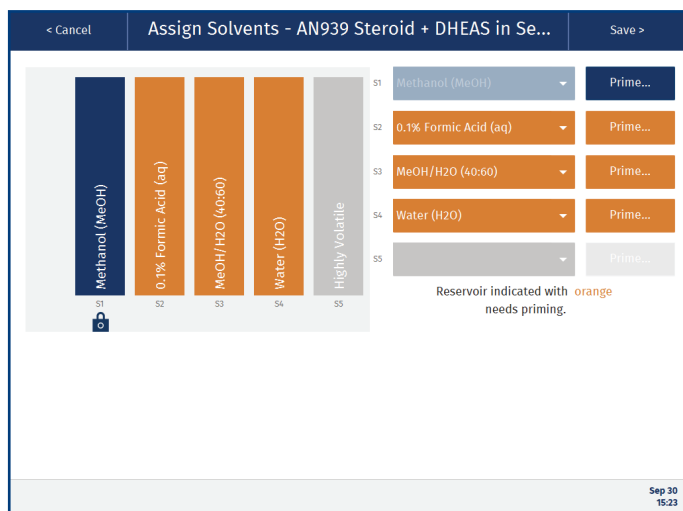

Figure 42. An orange solvent reservoir needs to be primed. A grey reservoir is either empty or not used in this run. Methanol is locked to S1 in this example and cannot be moved.

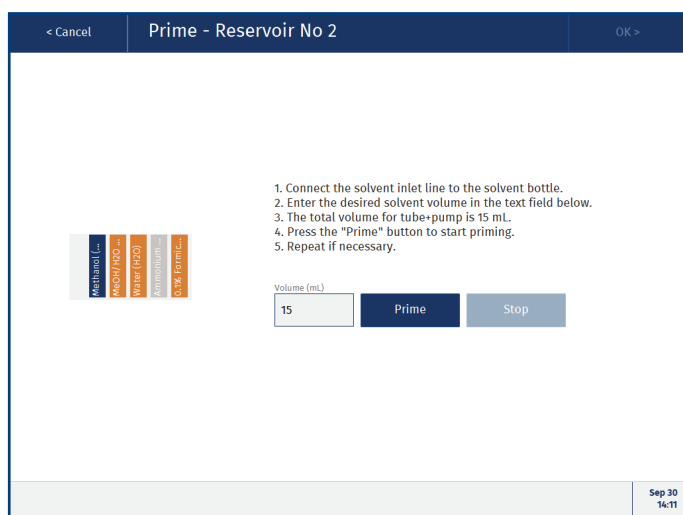

Figure 43. The Prime view for solvent reservoir S4.

- When done, press **Save** in the top pane.
- Ensure that the solvent feeder is in position, i.e. that it is blue in the **Prepare Run** view. The solvent feeder is orange when pushed back.

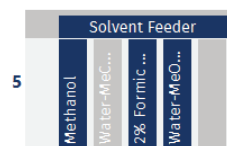

Figure 44. The Solvent Feeder is blue in the Prepare Run view when it is positioned over the reservoirs and orange when it has been pushed back.

Assign Manually Loaded Solvents (Optional)

If more than five solvents are required to run the method or if you prefer to load the solvents manually, setup a solvent rack in position **6** on the working area.

Note: The reservoirs cannot be refilled during the run.

Note: Each reservoir has a dead volume of 4 mL to prevent the system from aspirating air.

Note: We recommend that solvents that are defined as highly volatile are assigned to the solvent bottles; see “Assign Solvent Bottles and Prime” above.

Note: When running DFE methods, position **6** is used for the DFE column tips and cannot be used for solvents.

23. Press the illustration of the optional solvent reservoirs in the **Prepare Run** view (position **6**).

24. In the **Select Position 6 Accessory** view, select the 25 mL reservoir option, and press **Save**.

25. Press the illustration of the optional solvent reservoirs in the **Prepare Run** view (position **6**) and assign a solvent to each reservoir to be used; see Figure 45.

If a reservoir is orange, the total volume of that solvent is less than required for the run. Add another reservoir with the same solvent or consider having the solvent in one of the five solvent bottles (see “Assign Solvent Bottles and Prime” above).

26. When done, press **Save** in the top pane.

27. Fill a solvent rack with solvent reservoirs containing 25 mL of the solvents defined in step 25 and load the rack into position **6** on the working area.

The screenshot shows the 'Assign Solvents' interface for 'AN939 Steroid + DH...'. It displays five reservoirs labeled S6 through S10. S6 is assigned 'Water (H2O)', S7 is assigned '2% Formic Acid (aq)', and S8, S9, and S10 are currently empty. A warning message states: 'The required solvent volume is larger than the available volume in the reservoir(s) indicated with orange. Please assign the solvent(s) highlighted in orange to an additional reservoir(s). Ensure to fill each reservoir required with 25 mL of the appropriate solvent. Note that each reservoir has a dead volume of 4 mL to prevent the system from aspirating air.' The interface includes 'Cancel' and 'Save >' buttons at the top.

Figure 45. The reservoirs in position 6 have to be filled manually and cannot be refilled during the run. If a reservoir is orange, the total volume of that solvent is less than required for the run.

Load Carousel Plate(s)

Set Up the Carousel for SPE, SLE, PPT/PLD, Filtration, Filtration +, or Hydro DME+

28. Press the illustration of the carousel setup in the **Prepare Run** view.

29. Load the 96-well collection plate(s) onto the carousel as specified in the method; see the **Set Up Carousel** view (see Figure 46). Ensure to load them in the correct direction; see the location of the A1 position of the plate in Figure 47.

30. Load a flow-through plate for 96 plates and columns (P/N 414201SP) into position **D**.

The plate is used for guiding waste into the extraction waste collector, eliminating the risk of cross-contamination.

31. If desired, enter the IDs of the plates in the **Plate ID** text boxes. When done, press **Save** in the top pane.

Set Up the Carousel for DFE

28. Press the illustration of the carousel setup in the **Prepare Run** view.

29. Load DFE carousel risers (P/N 416868SP), plates, and solvents (if applicable) into the carousel as shown in the **Set Up Carousel** view (see Figure 46):

a. Load a DFE carousel riser into all carousel positions to be used for wash and elution.

b. If a waste position is defined in the method, load a flow-through plate for 96 plates and columns (P/N 414201SP) into that position. Do not use a DFE carousel riser.

c. Load the correct amount of the defined solvent into each wash/elution plate that is not to be filled by the system.

Note: If there is a pause in the method before the load step, the solvents can be loaded at that point.

d. Load the wash/elution plates into the correct carousel positions.

30. If desired, enter the IDs of the plates in the **Plate ID** text boxes.

31. When done, press **Save** in the top pane.

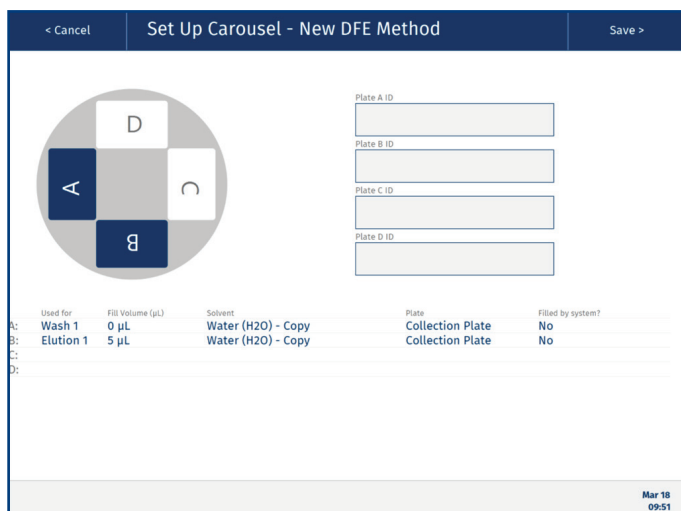

Figure 46. The Set Up Carousel view when setting up a DFE run on an Extrahera LV-200 system.

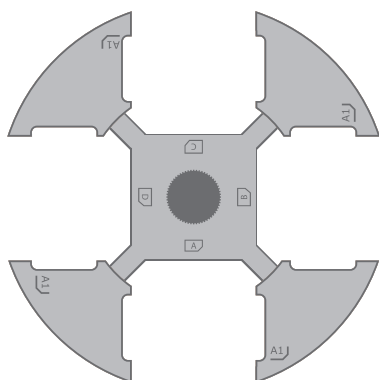

Figure 47. Ensure that the collection plates are loaded correctly into the carousel. Note the location of the A1 position of the plate.

Enter the Report Name and a Comment (Optional)

The name will be used in the **Reports** view and in the file name when exporting the report (see page 28). If no name is entered, the method name will be used.

32. Press the **Report and Comment** field in the **Prepare Run** view.
33. In the **Report Name and Comment** view, add a comment in the **Comment** text box and enter the name of the report in the **Report name** text box.
34. When done, press **Save** in the top pane.

Load the Sample Plate and Enter the Plate ID

35. Load the sample plate into position **4** on the working area. Ensure that the correct type of plate is used; see the run checklist in the **Prepare Run** view (see Figure 35 on page 20).
36. If desired, enter the sample plate ID by pressing the illustration of the sample plate in the **Prepare Run** view (position **4**) and entering the ID in the **Plate ID** text box.

Start the Run

37. In the **Prepare Run** view, press **Run** in the top pane. The **Run** dialog opens.
38. When a highly volatile solvent is assigned to a solvent reservoir in position **5**, its position is highlighted in the **Run** dialog (see Figure 48). Ensure that all highlighted reservoirs are empty.
39. To start the run, press **Run**.

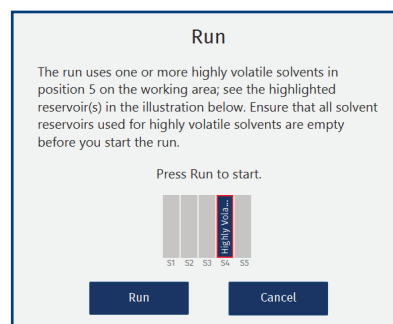

Figure 48. The Run dialog when using a highly volatile solvent in reservoir S4 on the working area.

Biotage® Extrahera™ GLP Features

- » The method audit trail can be accessed from the **Prepare Run** view.
- » Sample information can be entered, manually or by importing a sample batch worklist, by pressing the sample plate illustration in position **4**.
- » Carousel plate IDs can be entered by pressing the illustration of the carousel setup.
- » Pipette rack IDs can be entered in the **Set Up Solvent Tips** and **Set Up Sample Tips** views for position **1** and **2** on the working area.
- » Solvent IDs can be entered in the **Assign Solvents** view for position **5** and **6** on the working area.

For more information, see the Extrahera GLP User Manual (P/N 417250).

Monitor and Control a Run

Running

Monitor the Run

The progress of the run is displayed in the **Running** view; see Figure 49. If the method has been run before, the estimated time left is displayed in the top left corner.

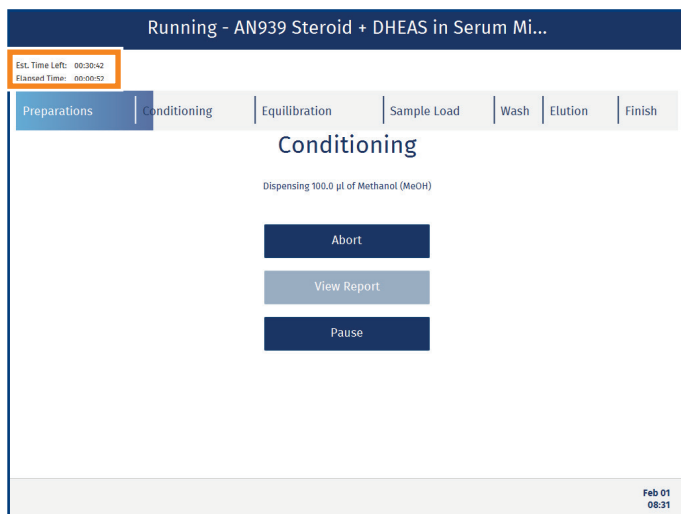

Figure 49. The Running view with the estimated time left displayed in the top left corner.

Visual and Audible Alarm

When a non-user-initiated or scheduled pause (defined in the method) occurs, the software background flashes in blue and an alarm with short beeps sounds. See Figure 50.

If a system error occurs, the software background flashes in red and an alarm with longer beeps sounds. See Figure 50.

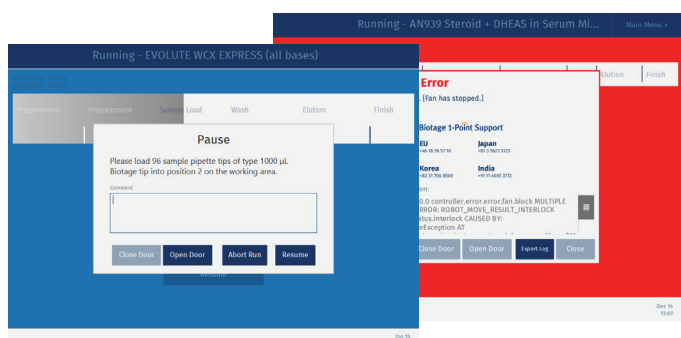

Figure 50. When a non-user-initiated or scheduled pause occurs, the software background flashes in blue (image in the front). If a system error occurs, the software background flashes in red (image in the back).

The alarm stops when the touch screen is pressed. If desired, the audible alarm can be disabled in the **Maintenance** view (see page 30).

Pause or Abort the Run

If you need to pause or abort a run that is in progress, press **Pause** or **Abort** in the **Running** view (see Figure 49). Note that the system will finish the task in progress before it pauses or ends the run. To cancel a “queued” pause, press **Cancel Pause**.

Pause

When the **Pause** dialog opens (see Figure 51), it is possible to open the door to, for example, load more pipette tips or check for clogged wells. If desired, a pause comment for the report can be entered. The report will also show when and for how long the door was opened.

If you wish to resume the run, press **Close Door** and then **Resume**. If you wish to abort the run, press **Abort Run**.

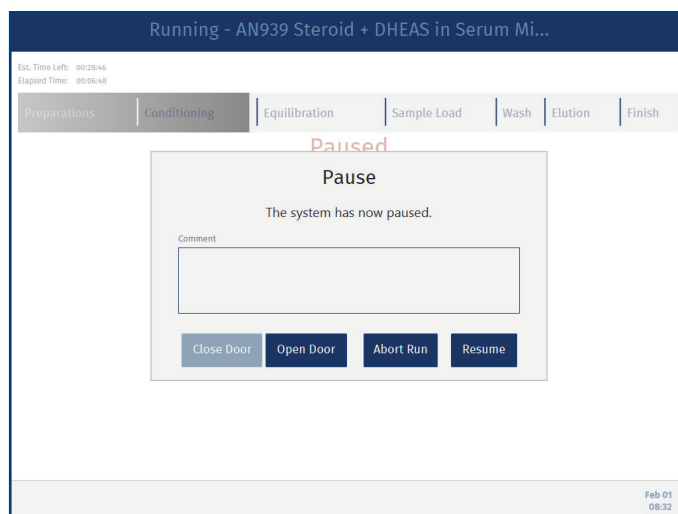

Figure 51. The Pause dialog.

Abort

When the **Abort** dialog opens, enter an abort comment for the report (if desired) and then press **Restore** to dispose of the pipette tips in use or return the DFE column tips in use (if any) and restore the system, i.e. return the pipette head, pressure unit, carousel, and lifter to their home positions.

When the run has been cancelled, please ensure that the correct number of pipette tips are available in the pipette racks (positions **1** and **2** on the working area) according to the setup in the **Prepare Run** view before starting a new run.

Post-Run Activities

Warning

- » All samples and waste should be treated as potentially biohazardous.
- » Handle chemical and liquid waste according to the Safety Data Sheets and to local/national guidelines on laboratory safety procedures.

1. Remove all plates and racks, and empty the pipette tip waste bin.
2. If the waste reservoir is full, open the waste valve to release the pressure, turn off the vacuum, and then empty the reservoir.
3. If you are leaving the system, you should also:
 - a. Empty the solvent reservoirs in position **5** and **6** on the working area and replace them with new, empty reservoirs.

Note: The solvent reservoirs are disposable.
 - b. Clean the extraction waste collector and the flow-through plate; see “Clean the Accessories” on page 31.
4. When necessary, clean the exterior and interior of the system and all the accessories as described on page 30.

Biotage® Extrahera™ GLP Features

- » E-mail notifications can be received when user interaction is required for your runs, and when they have been completed.
- » Clog detection can be enabled for any load, wash, and elute step in SPE and SLE methods, and the collection step in Filtration+ methods. If the **Clogged Wells Detected** dialog opens, the user is given the option to apply pressure (if enabled in the method), resume the run, or abort the run.
- » If the method has the **End of run comment** option enabled, the **End of Run** dialog opens when the run has been completed but before the report is generated.

For more information, see the Extrahera GLP User Manual (P/N 417250).

View, Export, and Delete Reports

Reports

Reports can be viewed, exported, and deleted in the **Reports** view; see Figure 52.

View a Report

The reports are organized in folders by month of creation, and can be sorted in chronological or alphabetical order within a folder by pressing the **Run Date** or **Report Name** header.

To display a report, select it and press **View**.

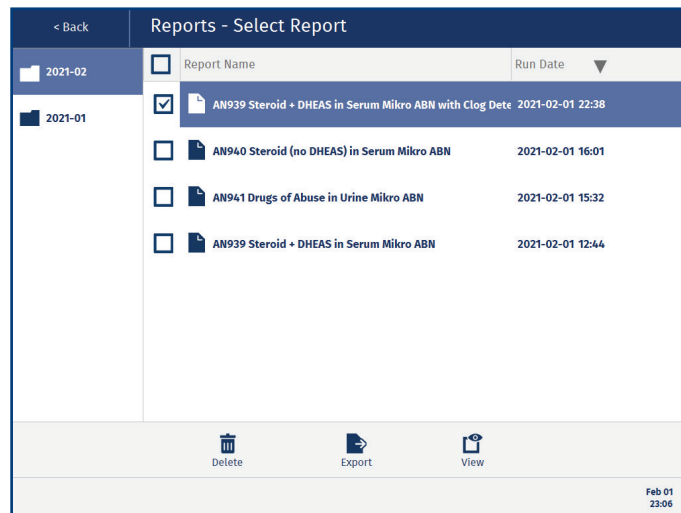

Figure 52. The Reports view. The reports can be sorted in chronological or alphabetical order.

Export Reports

1. Connect a USB memory device to one of the USB ports on the touch screen frame.
2. Select the report(s) that you want to export and press **Export**. To select all the reports in the folder, select the check box in the header.

The reports are saved as PDF files in a **reports** folder. The file name is based on the report name, run date, and start time, e.g. AN939_Steroid+_DHEAS_in_Serum_Mikro_ABN_20210201_1244.pdf.

Delete Reports

Note: Deleted reports cannot be recovered.

Delete one or more reports by selecting the report(s) and pressing **Delete**. Note that all reports in the folder will be deleted if you select the check box in the header.

Biotage® Extrahera™ GLP Features

- » Instead of saving the reports on the system, the reports can be saved in a network share folder.
- » Reports can be exported to a USB memory device and/or a network share folder depending on which export destinations that are available/allowed on the system.
- » Reports can be downloaded from the remote viewer (if enabled).
- » Only one report at a time can be deleted as the audit trail first has to be exported. The user has to enter a reason for deleting and the user password.
- » All import, export, and delete actions performed on the system, and all downloads of reports from the remote viewer are logged in a master audit trail.

For more information, see the Extrahera GLP User Manual (P/N 417250).

Enable/Disable the DFE Mode

In Dual Flow Extraction (DFE), the pressure unit is not used, the extraction media (the DFE column tips) are loaded into position 6 on the working area, and wash and elution operations are performed in position 3 using plates on the carousel.

For the lift to be able to move the carousel plates up into a position where they can be accessed by pipette and DFE column tips, the plate/rack frame in position 3 on the working area has to be removed and the **DFE mode** software option enabled.

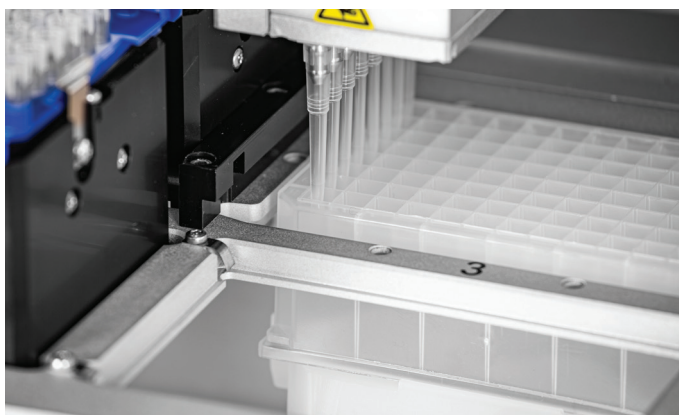

Figure 53. When running a DFE method, wash and elution plates are loaded into the carousel. By removing the plate/rack frame in position 3 on the working area, the carousel plates can be moved up into a position where the pipette and DFE column tips can access them.

Warning

- » The rack/plate frame in position 3 on the working area must be removed when the **DFE mode** option is enabled in the software, and installed when the **DFE mode** option is disabled.
- » Do not use a DFE carousel riser in combination with the flow-through plate.
- » Do not use a DFE carousel riser with the plate/rack frame installed in position 3.

Enable the DFE Mode

1. When the system is idle, remove any plates/racks located in position 3 and 4 on the working area.
2. Remove the plate/rack frame in position 3 using a T10 Torx screwdriver. Hold the frame in position while unscrewing the six screws (see Figure 55).
3. Clean the frame using a soft and clean cloth. The cloth can be dry or lightly dampened with a cleaning solution that is suitable for the residues. Store the frame and the six screws in a clean and dry place until the next use.
4. Press **Maintenance** in the software's main menu.
5. Enable the **DFE mode** option; see Figure 56 on page 30.

6. In the **Confirm Removal of Frame** dialog, press **OK** to confirm that the plate/rack frame is removed (see Figure 54).

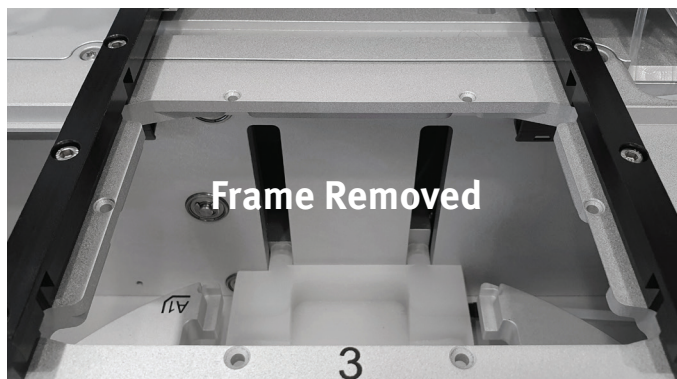

Figure 54. With the plate/rack frame removed, it is possible to run DFE methods.

Disable the DFE Mode

1. When the system is idle, remove any plate located in position 4 on the working area.
2. Install the plate/rack frame in position 3 using the six screws and a Torx 10 screwdriver; see Figure 55.
3. Press **Maintenance** in the software's main menu.
4. Disable the **DFE mode** option; see Figure 56 on page 30.
5. In the **Confirm Plate/Rack Frame** dialog, press **OK** to confirm that the plate/rack frame is in place (see Figure 55).

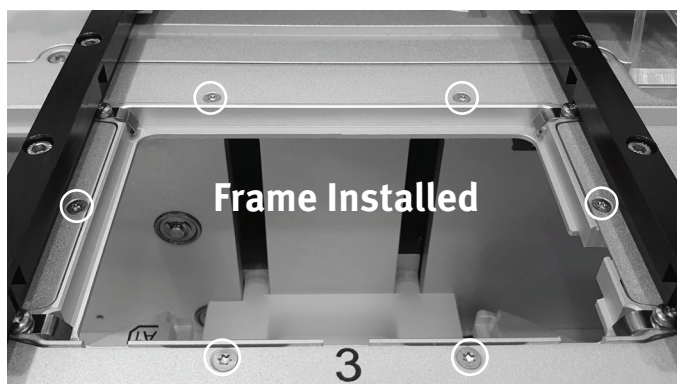

Figure 55. With the plate/rack frame in place, it is possible to load an extraction plate/rack into position 3 and run any method except for DFE.

Maintenance

Maintenance

The **Maintenance** view (see Figure 56) contains the system settings listed in the “Change the System Settings” section below and the following maintenance features:

- » **Calibrate Pipette Pump:** See “Pipette Pump Calibration and Adjustment” on page 34.
- » **Manual Control:** Used for method development and maintenance tasks; see page 37.
- » **Flush Solvent Inlets:** Used for cleaning the solvent pump and tubing and for emptying the tubing before replacing it (see “Replace the Solvent Tubing” on page 32).
- » **Export Logs:** Used for exporting the system logs when they are required for troubleshooting by Biotage® 1-Point Support™; see “Export the System Logs” below.
- » **Re-Initialize System:** Used for restoring the system to its initial state, i.e. the system returns the pipette head, pressure unit, carousel, and lifter to their home positions.

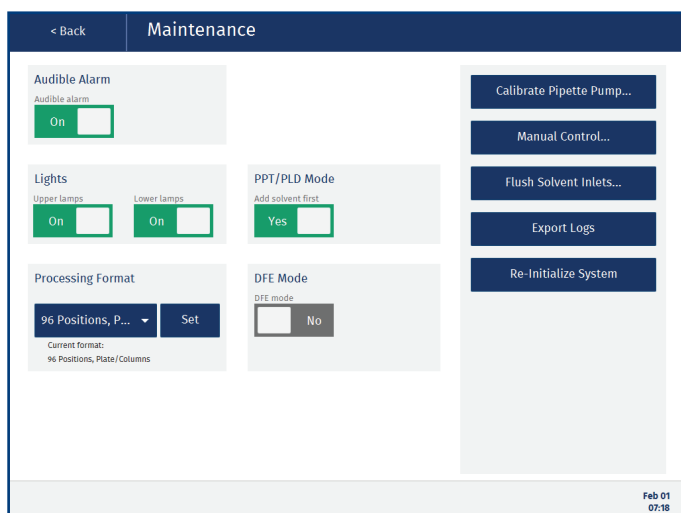

Figure 56. The Maintenance view.

Change the System Settings

In the **Maintenance** view, the following system settings are available (see Figure 56):

- » **Audible Alarm:** Whether an audible alarm will sound or not for non-user-initiated pauses, scheduled pauses (defined in the method), and system errors. For more information, see “Visual and Audible Alarm” on page 4.
- » **Lights:** Whether the lamps inside the system will be lit or not when the system is on. There is one control for the upper lamps and one for the lower.

- » **Processing Format:** The type of extraction media that can be processed on the system.
- » **PPT/PLD Mode:** Whether the sample will be added before or after the solvent. This setting is used when creating new PPT/PLD methods and does not affect a method that has already been created.

Biotage® Extrahera™ GLP Feature

The sample batch worklist headers can be configured by pressing **Headers...** in the **Maintenance** view. For more information, see the Extrahera GLP User Manual (P/N 417250).

Export the System Logs

When reporting a problem with your system to Biotage 1-Point Support, you may be requested to send in the system logs.

1. Connect a USB memory device to one of the USB ports on the touch screen frame.
2. Press **Export Logs**.

The logs are saved as a zip file in a **logs** folder. The file name is *logs_serialnumber_date_time.zip*.

Note: The system log files are password protected and can only be read by Biotage 1-Point Support.

Biotage® Extrahera™ GLP Feature

The system log files can be exported to a USB memory device and/or a network share folder depending on which export destinations that are available/allowed on the system.

Clean the Exterior of the System

Warning

- » Ensure that the system is turned off and the power cord is disconnected before cleaning.
- » Never leave solvents, samples, or waste inside the system when the ventilation is turned off.

If the touch screen has been contaminated by chemicals, it must be cleaned immediately.

1. Shut down the system by pressing **Shut Down** in the main menu or login view (GLP) and then **Yes** to confirm.
2. When the message saying that it is safe to turn off the system appears on the screen, turn off the system and disconnect the power cord.
3. If there are solvent racks that contain liquid in position **5** and **6** on the working area, empty the racks or place them in a fume hood until the system has been switched back on.

4. Remove any plates and racks that contain solvent and/or sample and empty the pipette tip waste bin.
5. Clean the touch screen and the exterior of the system, using a soft and clean cloth. The cloth can be dry or lightly dampened with a neutral detergent or alcohol.
6. When the system has been cleaned, connect the power cord and turn on the system.

Clean the Interior of the System

Warning

- » Ensure that the system is turned off and the power cord is disconnected before cleaning.
- » All samples and waste should be treated as potentially biohazardous.
- » Never leave solvents, samples, or waste inside the system when the ventilation is turned off.
- » Handle chemical and liquid waste according to the Safety Data Sheets and to local/national guidelines on laboratory safety procedures.

1. Shut down the system by pressing **Shut Down** in the main menu or login view (GLP) and then **Yes** to confirm.
 2. When the message saying that it is safe to turn off the system appears on the screen, turn off the system and disconnect the power cord.
 3. If there are solvent racks that contain liquid in position **5** and **6** on the working area, empty the racks or place them in a fume hood until the system has been switched back on.
 4. Remove any plates and racks that contain solvent and/or sample and empty the pipette tip waste bin.
 5. Clean the interior of the system, using a soft and clean cloth. The cloth can be dry or lightly dampened with a cleaning solution that is suitable for the residues. If desired, the carousel can be removed for better access by unscrewing the center knob (see Figure 57).
- Note:** Only use water, IPA, or ethanol when cleaning the door and the side walls.
6. Allow the system to dry completely before reconnecting the power cord and turning it back on.

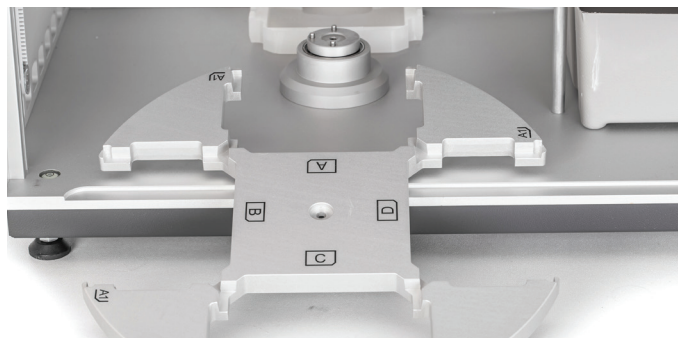

Figure 57. The carousel can be removed for better access when cleaning the interior of the system.

Clean the Accessories

When necessary, clean the column rack (if used) solvent rack(s), pipette racks, pipette tip waste bin, extraction waste collector, flow-through plate, and DFE carousel risers (if used) using a dishwasher program for plastic with a maximum cleaning temperature of 95°C.

To clean without using a laboratory dishwasher, use soap, water, and/or ethanol.

Note: The solvent reservoirs used inside the system are disposable.

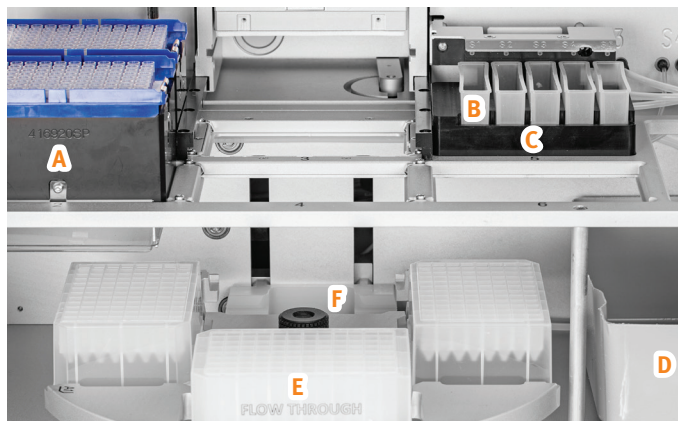

Figure 58. A = pipette rack, B = solvent reservoir, C = solvent rack, D = pipette tip waste bin, E = flow-through plate, and F = extraction waste collector.

Remove the Extraction Waste Collector

1. Press **Maintenance** in the main menu and then **Manual Control...**
2. If there are plates on the carousel, press **Open** in the **Door** field (if applicable) and remove them.
3. Press **Close** in the **Door** field.

4. If there is liquid in the extraction waste collector and/or in the waste tubing, ensure that the vacuum is on and press **Open** in the **Waste Valve** field to clean the waste tubing. When done, press **Close** in the **Waste Valve** field.
 - a. Ensure that the vacuum is on.
 - b. When the liquid has been removed, press **Close** in the **Waste Valve** field.
5. Press **Move Out** in the **Pressure Unit** field.
6. Press **Raise** in the **Extraction Waste Collector** field.
7. Open the door by pressing **Open** in the **Door** field.
8. Remove the extraction waste collector by pulling it straight out.
9. Unscrew the waste tube connected on the right side of the extraction waste collector; see Figure 59.
10. Ensure that the O-rings on the mounting pins are correctly seated; see Figure 59.



Figure 59. Removing the extraction waste collector. In this image, the carousel has been removed, which is not required. The mounting pins are highlighted.

Reinstall the Extraction Waste Collector

When the extraction waste collector has been cleaned, put it back in place and restore the system to its initial state:

1. Reconnect the waste tube to the extraction waste collector and put the extraction waste back in place.
2. Restore the system to its initial state by pressing **Back** in the top pane, **Re-Initialize System** in the **Maintenance** view, and then **Yes** to confirm.

Replace the Solvent Tubing

Warning

- » Ensure that the system is turned off and the power cord is disconnected before replacing the tubing.
- » Never leave solvents, samples, or waste inside the system when the ventilation is turned off.
- » Use only tubing, nuts, and ferrules supplied by Biotage.
- » Use caution when finger-tightening fittings to prevent stripped threads or crushed ferrules.
- » Handle chemical and liquid waste according to the Safety Data Sheets and to local/national guidelines on laboratory safety procedures.

1. Empty the solvent inlet lines of liquid by flushing with air:
 - a. Remove the solvent inlet lines from their bottles and place them in an empty, clean bottle.
 - b. Ensure that you have five empty solvent reservoirs in the solvent rack in position **5** on the working area.
 - c. Press **Maintenance** in the main menu and then **Flush Solvent Inlets...**
 - d. Enter the flush volume for S1. 25 mL is required to empty the solvent inlet line and pump of liquid.
 - e. Press **Flush** for S1.
 - f. When done flushing the inlet line with air, repeat steps d through e for the other solvent inlet lines (S2-S5).
2. Shut down the system by pressing **Shut Down** in the main menu or login view (GLP) and then **Yes** to confirm.
3. When the message saying that it is safe to turn off the system appears on the screen, turn off the system and disconnect the power cord.
4. Remove the solvent rack in position **5** on the working area and empty it of solvent.
5. If there is a solvent rack in position **6** on the working area that contains liquid, empty the rack or place it in a fume hood until the system has been switched back on.
6. Remove any plates and racks that contain solvent and/or sample and empty the pipette tip waste bin.
7. Remove the solvent feeder by pulling it straight out.
8. To replace the five solvent inlet lines (see Figure 60), unscrew them from the back wall and mount new ones. Ensure to tighten the screw connectors properly.



Figure 60. The solvent inlet connections at the back wall.

9. To replace the five solvent tubes between the back wall and the solvent feeder:
 - a. Unscrew the tubes from the back wall (see Figure 61).
 - b. Open the solvent feeder by unscrewing the two screws and remove the old tubes.
 - c. Reassemble the solvent feeder with new tubes.
 - d. Connect the new tubes to the back wall. Ensure to tighten the screw connectors properly.

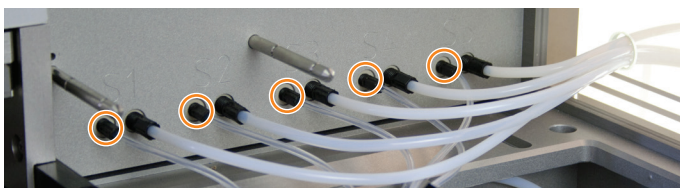

Figure 61. The connections on the back wall for the five solvent tubes connected to the solvent feeder.

10. Put the solvent feeder back in place. Ensure that the tubes are positioned correctly; see Figure 62.



Figure 62. All the solvent tubes in position.

11. Put the solvent rack back in place and pull out the solvent feeder; see Figure 63.



Figure 63. The solvent feeder in position.

12. When done, connect the power cord and turn on the system.
13. Press **Maintenance** in the main menu and check all tubes and connections for leaks using the **Flush Solvent Inlets** function. If a leak is detected, tighten the solvent's two screw connectors on the back wall. If air is visible in one of the tubes between the back wall and the solvent feeder, tighten the inlet line connector for that solvent.

Note: A solvent that is not cleared from its inlet line (S1-S5) in the **Flush Solvent Inlets** view will appear in the same position in the **Prepare Run** view.

Clean or Replace the Waste Tubing

Warning

- » Clean the waste tubing regularly to avoid leakage caused by the tubing getting clogged.
- » Use only tubing, nuts, and ferrules supplied by Biotage.
- » Use caution when finger-tightening fittings to prevent stripped threads or crushed ferrules.

Clean the Waste Tubing

1. Remove the extraction waste collector and disconnect the waste tube from the extraction waste collector as described in "Remove the Extraction Waste Collector" on page 31.
2. Insert the waste tube into a container with a cleaning solution that is suitable for the residues.
3. Ensure that the vacuum is on and press **Open** in the **Waste Valve** field to clean the waste tubing. When done, press **Close** in the **Waste Valve** field.
4. Remove the container with the cleaning solution.
5. Put the waste tube and extraction waste collector back in place and restore the system to its initial state as described in "Reinstall the Extraction Waste Collector" on page 32.

Replace the Waste Tubing

1. Press **Maintenance** in the main menu and then **Manual Control...**
2. If there is liquid in the extraction waste collector and/or in the waste tubing, ensure that the vacuum is on and press **Open** in the **Waste Valve** field to empty the waste tubing. When done, press **Close** in the **Waste Valve** field.
3. To replace the waste tube connected between the extraction waste collector and the waste manifold (see A in Figure 64):
 - a. If there are plates on the carousel, press **Open** in the **Door** field (if applicable) and remove them.
 - b. Press **Close** in the **Door** field.
 - c. Press **Move Out** in the **Pressure Unit** field.
 - d. Press **Raise** in the **Extraction Waste Collector** field.
 - e. Press **Open** in the **Door** field.
 - f. Remove the extraction waste collector by pulling it straight out.
 - g. Unscrew and replace the tube (see A in Figure 64). Ensure to secure the tube in the correct position using the holders/clips that are highlighted.
 - h. Put the extraction waste collector back in place.
4. To replace the waste tube between the waste manifold and the waste valve, turn off the vacuum and unscrew and replace the tube (see B in Figure 64).

5. To replace the waste outlet tubing connected between the waste valve and the waste reservoir (see C in Figure 64):
 - a. Turn off the vacuum.
 - b. Release the pressure in the tubing by pressing **Open** in the **Waste Valve** field.
 - c. If the door is closed, press **Open** in the **Door** field.
 - d. Unscrew and replace the tubing (see C in Figure 64).
 - e. Close the waste valve by pressing **Close** in the **Waste Valve** field.
6. When done, restore the system to its initial state by pressing **Back** in the top pane, **Re-Initialize System** in the **Maintenance** view, and then **Yes** to confirm.

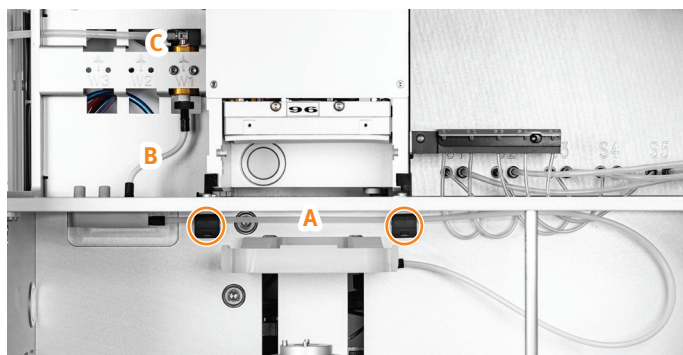

Figure 64. The three waste tubes (A, B, and C). Note the two tube holders/clips above the extraction waste collector.

Pipette Pump Calibration and Adjustment

You need a 96-well sample plate, the appropriate number of tubes for individual weighing (see “Calibrate”), a scale with 0.1 mg readability, and deionized water.

Set Up Calibration Methods

Calibrate using two calibration volumes that are appropriate for your applications. To calibrate the whole interval for a pipette tip, use the calibration volumes 5 μL and 50 μL (the 50 μL tip) or 20 μL and 200 μL (the 200 μL tip).

Either use two of the predefined calibration methods or create your own methods by copying a predefined method and changing the calibration volume.

Calibrate

Calibrate an aspiration volume as described below. If the accuracy is not within specification, adjust as described in “Adjustment” below and then calibrate again. If the precision is outside the specification, see “Pipette Pump” on page 39.

1. Weigh empty tubes and place them in the sample plate. We recommend that you use 12 tubes for each pipette nozzle, i.e. in total 96 tubes, which means that
2. Press **Run Method** in the main menu.

3. Select the method for the volume to be calibrated and press **Prepare Run** in the top pane.
4. Press the illustration of the extraction media (position 3), enable the **Use all columns** option or select e.g. every second column and run the sample plate in several runs (see note below), and then press **Save** in the top pane.

Note: To minimize evaporation, the plate can be divided into several runs.
5. Prime the solvent pump until water comes out of the solvent feeder:
 - a. Press the illustration of the solvent reservoirs in the **Prepare Run** view (positions 5).
 - b. Press **Prime...** for the solvent inlet line that contains water.
 - c. Ensure that the solvent reservoir is empty. If not, replace it with a new, empty one.
 - d. Enter the prime volume. Approximately 2-3 times 15 mL is required to fill the solvent inlet line and pump with water.

Note: The solvent reservoir can contain a maximum of 25 mL.
 - e. Press **Prime**.
 - f. If necessary, empty the solvent reservoir and prime again. Ensure that there are no air bubbles visible in the tubes. If you have problems with air bubbles, check the solvent’s screw connectors on the back wall.
 - g. When you have finished priming, press **OK** and then **Save** in the top pane.

Note: You only need to prime before the first calibration.
6. If desired, enter the sample plate ID.
7. Press **Run**.
8. When finished, weigh the individual tubes again and calculate:
 - a. Individual volumes. Take temperature into account when choosing the water density value.
 - b. Average, accuracy, and coefficient of variation (CV) for the individual channels and the entire set.
9. If the accuracy is outside the specification, adjust the system as described below. The technical specifications are the following for the 5000 μL pipette tip (P/N 417007), but it is your responsibility to ensure that the result is within the tolerance for your applications:
 - » Specifications for the 50 μL pipette tip (P/N 417008):
 - At 5 μL : $\pm 5.0\%$ accuracy and 5.0% CV
 - At 10 μL : $\pm 5.0\%$ accuracy and 5.0% CV
 - At 25 μL : $\pm 4.0\%$ accuracy and 2.5% CV
 - At 50 μL : $\pm 2.5\%$ accuracy and 2.0% CV
 - » Specifications for the 200 μL pipette tip (P/N 417009):
 - At 20 μL : $\pm 5.0\%$ accuracy and 5.0% CV
 - At 100 μL : $\pm 2.0\%$ accuracy and 1.5% CV
 - At 200 μL : $\pm 1.5\%$ accuracy and 1.0% CV

Adjustment

If the accuracy is outside the specification, adjust the system as described below and repeat the calibration.

1. Press **Maintenance** in the main menu.
2. Press **Calibrate Pipette Pump...**
3. Select the pipette tip used for the calibration from the **Pipette tip type** drop-down list.
4. Set **Desired volume one** to the first calibration volume.
5. Set **Obtained volume one** for the first calibration volume to the average for the entire set as calculated in the calibration step above.
6. Set **Desired volume two** to the second calibration volume.
7. Set **Obtained volume two** for the second calibration volume to the average for the entire set as calculated in the calibration step above.
8. Press **Calculate**. The calculated calibration coefficient and offset is displayed.
9. If you want to use the calculated values, press **Apply** and then **Save** in the top pane.
10. Verify that the accuracy is within specification by repeating the calibration.

Figure 65. The Calibrate Pipette Pump view.

It is possible to restore an old set of calibration coefficient and offset values by selecting the values, pressing **Restore Selected Values**, and then pressing **Save** in the top pane. Note that the coefficient and offset values that are used when performing a calibration are taken into account when calculating new values.

Replace the Pressure Head Seal

1. Remove any plates located in position **3** and **4** on the working area.
2. Remove the two screws holding the pressure head to the pressure unit using the T20 Torx screwdriver supplied with the system; see Figure 66.

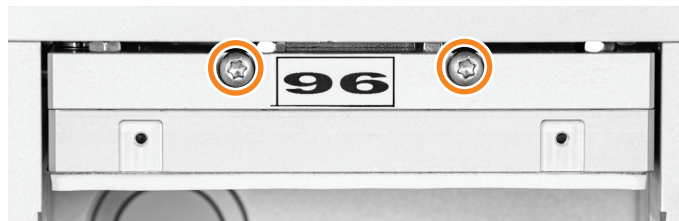

Figure 66. The two screws attaching the pressure head to the pressure unit.

3. Remove the pressure head by pulling it down and then pulling it out.
4. Disconnect the gas tubes from the pressure head by pushing in the collar of each connector against the fitting and pulling the tubing out.
5. Put the pressure head on a clean and lint-free surface.
6. Pull off the old pressure head seal. Note that the seal cannot be reused.
7. Remove the paper liner on the new self-adhesive pressure head seal.
8. Apply the seal to the pressure head. Ensure that there are no air bubbles between the seal and the pressure head.
9. Reconnect the gas tubes. Ensure that the tubes are properly fastened by pulling on them, and that the tubes are on the left side of the bracket as shown in Figure 67.
10. Put the pressure head back in place using the two screws. Do not overtighten the screws.

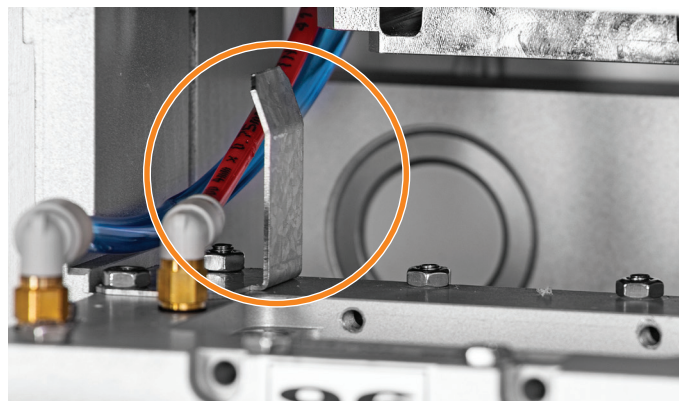

Figure 67. Ensure that the gas tubes are on the left side of the highlighted bracket.

Replace the Fuses

Warning

- » Ensure that the system is turned off and the power cord is disconnected before replacing the fuses.
- » Use only exact replacement fuses supplied by Biotage. Incorrect fuses create a potential fire hazard.
- » Never leave solvents, samples, or waste inside the system when the ventilation is turned off.

1. Shut down the system by pressing **Shut Down** in the main menu or login view (GLP) and then **Yes** to confirm.
2. When the message saying that it is safe to turn off the system appears on the screen, turn off the system and disconnect the power cord.
3. If there are solvent racks that contain liquid in position **5** and **6** on the working area, empty the racks or place them in a fume hood until the system has been switched back on.
4. Remove any plates and racks that contain solvent and/or sample and empty the pipette tip waste bin.
5. Unscrew the two fuse holders at the power inlet on the right side of the system; see Figure 68.

Note: Do not touch the metal surfaces with your hands after the fuses have been cleaned.

7. Replace both of the old fuses.
8. Put the two fuse holders back in place.

Note: If the fuses blow shortly after replacing them, contact Biotage 1-Point Support.

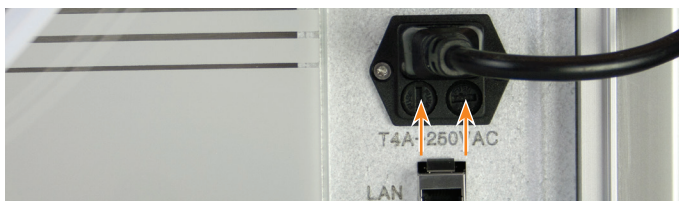

Figure 68. Fuse holders at the power inlet.

Drain the Filter Unit

When liquid is visible in either sight glass of the first two filters (the two filters to the left in Figure 69), drain them by opening the screw at the bottom of the filters.

Replace the Filters in the Filter Unit

We recommend that the three filters in the filter unit are replaced once every year (P/N 416492SP includes all three filters).

If you can see red spots in the color check window on the last filter (the filter to the right in Figure 69), replace it immediately.

1. Before replacing the filters, the pressure head must be removed to protect it from contamination; see steps 1 through 5 in “Replace the Pressure Head Seal” on page 35.
2. Disconnect the filter unit from the system.
3. Replace the filters.
4. Put the filter unit back in place.



Figure 69. The setup of the filter unit for the N₂ port.

5. Purge the system:
 - a. Press **Maintenance** in the main menu and then **Manual Control....**
 - b. In the **Manual Control** view (see Figure 70), press **Close** in the **Door** field.
 - c. Press **Move Out** in the **Pressure Unit** field.
 - d. Enter 0.5 bar and 15 seconds in the **Pressure Head - Processing** field and then press **Start**.
 - e. Press **Move In** in the **Pressure Unit** field.
 - f. Press **Open** in the **Door** field.

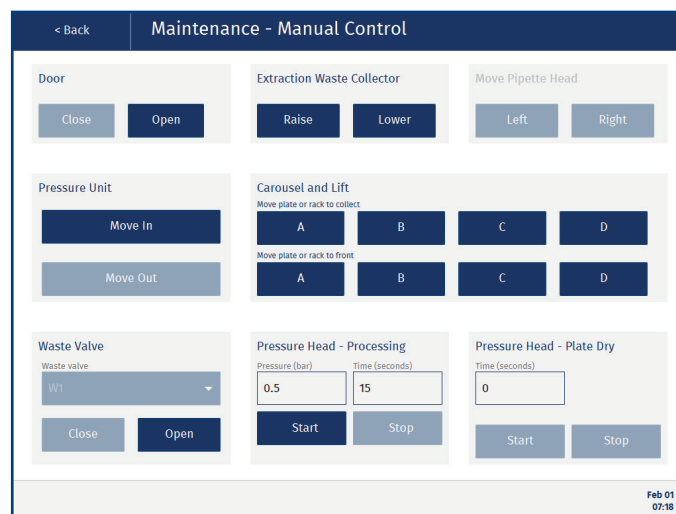

Figure 70. The Manual Control view.

6. Put the pressure head back in place; see steps 9 and 10 in “Replace the Pressure Head Seal” on page 35.
7. When you are done, restore the system to its initial state by pressing **Back** in the top pane, **Re-Initialize System** in the **Maintenance** view, and then **Yes** to confirm.

Manual Control

Maintenance

To control the system manually e.g. to perform method development (not DFE) or maintenance tasks (see page 30), press **Maintenance** in the main menu and then **Manual Control...**

Note: All functions except for the waste valve control are disabled when the door is open.

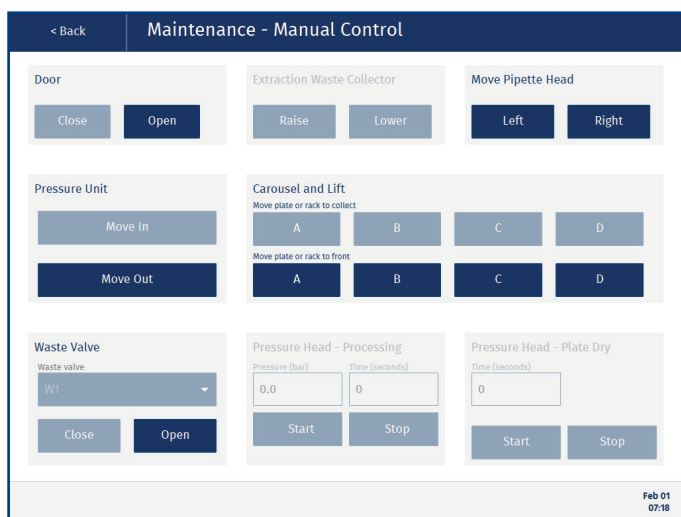

Figure 71. The Manual Control view.

Door

Functionality for opening and closing the door.

Note: After the door is closed, the carousel is homed and, if applicable, the pressure head is moved in, the pipette head is moved to the right, and the extraction waste collector is lowered.

Maintenance

Extraction Waste Collector

Functionality for raising the extraction waste collector so that it can be removed. Used in the following maintenance tasks: “Clean the Accessories” on page 31 and “Clean or Replace the Waste Tubing” on page 33.

Note: It is not possible to raise the extraction waste collector when the pressure unit is in its inner position.

Move Pipette Head

Functionality for moving the pipette head into a position where it can be easily accessed to e.g. clean the nozzles.

Note: It is not possible to move the pipette head when the pressure unit is in its outer position.

Waste Valve

Functionality for opening and closing the waste valve. Used in the following maintenance tasks: “Remove the Extraction Waste Collector” on page 31 and “Clean or Replace the Waste Tubing” on page 33.

Pressure Unit and Pressure Head

Functionality for moving the pressure head and applying pressure is required when the system has to be purged; see “Replace the Filters in the Filter Unit” on page 36).

Method Development

This section is not applicable for DFE methods.

Pressure Unit

To process an extraction plate or column rack (in position **3** on the working area), first move the pressure head in position by pressing **Move Out** in the **Pressure Unit** field.

To unload an extraction plate/rack, press **Move In** in the **Pressure Unit** field. To open the door, press **Open** in the **Door** field.

Carousel and Lift

To lift a flow-through plate or a collection plate on the carousel to the position just underneath the extraction plate or column rack, press its position (**A-D**) using the **Move plate or rack to collect** buttons.

To unload or load a flow-through plate or a collection plate on the carousel, press its position (**A-D**) using the **Move plate or rack to front** buttons. This lowers the lift and moves the selected position to the outer position. To open the door, press **Open** in the **Door** field.

Note: It is not possible to lift a collection plate when the pressure unit is in its inner position.

Waste Valve

When using a flow-through plate, the vacuum must be turned on and the waste valve opened in the **Waste Valve** field before applying pressure.

Pressure Head

To apply a processing pressure with a gas flow of between 0 and 10 mL/min, enter the desired pressure (up to 5 bar) and time in the **Pressure Head - Processing** field and then press **Start**.

To apply a plate dry with a gas flow of approximately 600 mL/min and a pressure at 5 bar, enter the desired time in the **Pressure Head - Plate Dry** field and press **Start**.

Note: The pressure head must be moved out to apply pressure.

Set Up Reminders for Pipette Pump Calibrations

System Administration

The pipette pump can be calibrated for all types of pipette and DFE tips that are used on the system. Reminders for pipette pump calibrations can be set up in the **System Administration** view (see Figure 72).

The following settings are available:

- » **Notifications:** If enabled, the system will notify the user that a pipette pump calibration has expired at startup and/or before a run is started, depending on the setting for the following two options.
 - Note:** If none of the following two options are enabled, the user will not be notified but the reports will contain a note that the run was performed with an expired pipette pump calibration.
- » **Notify during startup:** The system will pop up a notification at startup.
- » **Notify before starting a run:** The system will pop up a notification before a run is started.
- » **Time between notifications:** How often the pipette pump should be calibrated; once a month, once every third month, once every sixth month, or once a year.

The pipette pump can be calibrated in the **Maintenance** view (see page 34).

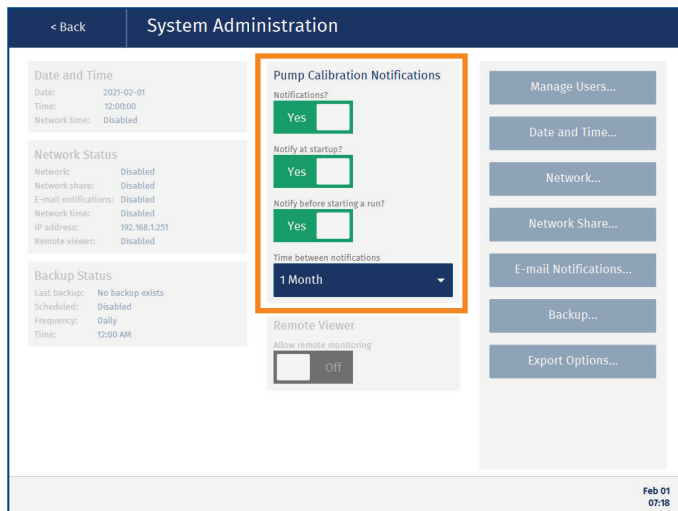

Figure 72. The Pump Calibration Notifications section in the System Administration view. The rest of the features in this view require an Extrahera GLP software license.

Troubleshooting

If you need to restore the system to its initial state, press **Maintenance** in the main menu, press **Re-Initialize System**, and then **Yes** to confirm.

Dual Flow Extraction Tips

If you see big differences in the volumes being aspirated into the DFE column tips, fluid may have entered the pump:

- » Contact Biotage 1-Point Support.
- » Check that the capacity parameter for the DFE column tip is set to the correct value; see “Manage Dual Flow Extraction Tips” on page 12.

If the DFE column tips collide with system components or consumables during the process:

- » Check that the correct DFE column tips are placed in the pipette rack in position **6**.
- » Check that the length parameter for the tip is set to the correct value; see “Manage Dual Flow Extraction Tips” on page 12.
- » Check that the sample plate in position **4** is correctly tuned; see “Manage Sample Plates” on page 10.
- » Check that the wash and elution plates on the carousel are correctly tuned; see “Manage Carousel Plates” on page 11.
- » Check that the aspiration and dispensation heights are defined correctly for the load operation in the used DFE method.
- » Check that the aspiration and dispensation heights are defined correctly for any residual purges in the load, wash, and elution operations in the used DFE method.

If the pipette rack in position **6** is moved out of its position by the robot, it may be because the retaining clips on the pipette rack are worn out and need to be replaced (P/N 414307SP). If replacing the clips does not solve the problem, please contact Biotage 1-Point Support.

Pipette Pump

If you suspect that the pipetting precision or accuracy is incorrect, calibrate and adjust the system as described in “Pipette Pump Calibration and Adjustment” on page 34.

If the precision of the system is outside the specification when measured as described on page 34:

- » Check that the correct pipette tip type is used.
- » Check that new pipette tips are used.

- » Check that the nozzles on the pipette head are securely tightened.
- » If the precision is still outside the specification, contact Biotage 1-Point Support.

Pipetting Tips

Check that the pipette tip waste bin has sufficient space for pipette tips being disposed during the run and that the waste bin is correctly positioned with no collision risk for the carousel or the door.

If you see big differences in the volumes being aspirated into the pipette tips, fluid may have entered the pump:

- » Contact Biotage 1-Point Support.
- » Check that the capacity parameter for the pipette tip is set to the correct value; see “Manage Pipette Tips” on page 11. If the pipette tips collide with system components or consumables during the process:
- » Check that the correct pipette tips are placed in the pipette rack in position **1** or **2**.
- » Check that the length parameter for the pipette tip is set to the correct value; see “Manage Pipette Tips” on page 11.
- » Check that the sample plate position **4** is correctly tuned; see “Manage Sample Plates” on page 10.
- » Check that the extraction plate or column rack in position **3** (if used) is correctly tuned; see “Manage Extraction Media” on page 9.
- » Check that the DFE wash and elution plates on the carousel (if used) are correctly tuned; see “Manage Carousel Plates” on page 11.

If the pipette rack in position **1** or **2** is moved out of its position by the robot, it may be because the retaining clips on the pipette rack are worn out and need to be replaced (P/N 414307SP). If replacing the clips does not solve the problem, please contact Biotage 1-Point Support.

Power Failure

The system has open solvent reservoirs. If the ventilation fails and solvent vapors are not removed, an explosive environment can be generated. If the system is found with the door closed and the power off, you must ventilate the system properly before turning it back on. Follow the instructions in “Power Failure” on page 5.

Pressure Head

If the pressure head collides with the extraction plate or columns:

- » Check that the extraction plate or columns are supported and correctly configured.
- » Check that the extraction plate or columns are correctly positioned and level.

Pressurized Air and Nitrogen

If there is a leakage when pressurized air or nitrogen is applied:

- » Check that the gas tubing is securely attached.
- » Check that the correct gas tubing is used; the outer diameter should be 6 mm and the inner diameter 4 mm. Always use tubing supplied by Biotage.

If the pressure head does not move down or up:

- » Check that the **AIR** inlet at the right side of the system is connected to pressurized air or nitrogen and that the pressure is suitable for the method. Use 6 ± 0.2 bar (0.6 ± 0.02 MPa; 87 ± 3 psi) for a fully populated extraction plate/rack and lower to approximately 4 bar (0.4 MPa; 58 psi) when 50% of the plate/rack is populated and 3 bar (0.3 MPa; 44 psi) when 25% of the plate/rack is populated.
- » Check that all external valves for the incoming air are open.

If the extraction plate or columns do not empty:

- » Check that the **N₂** inlet at the right side of the system is connected to nitrogen or pressurized air at 6 ± 0.2 bar (0.6 ± 0.02 MPa; 87 ± 3 psi).
- » Check that the **AIR** inlet at the right side of the system is connected to pressurized air or nitrogen and that the pressure is suitable for the method. The gas connected to the **AIR** port is used to seal the plate/columns and its pressure has to be adjusted according to how many positions in the plate/column rack that are populated. Use 6 ± 0.2 bar (0.6 ± 0.02 MPa; 87 ± 3 psi) for a fully populated extraction plate/rack and lower to approximately 4 bar (0.4 MPa; 58 psi) when 50% of the plate/rack is populated and 3 bar (0.3 MPa; 44 psi) when 25% of the plate/rack is populated.
- » Check that all external valves for the incoming pressurized air and/or nitrogen are open.
- » Check that the extraction plate or columns are not damaged.
- » Check that the gas tubes are connected properly to the pressure head and that the pressure head seal and tubing is not damaged. See instructions on how to remove the pressure head in “Replace the Pressure Head Seal” on page 35.

Retaining Clips

Position **3** and **4** on the working area have retaining clips to keep the plate/rack in position. If it is difficult to insert or remove a plate/rack or the extraction plate/rack is moved out of its position when the pressure head is lifted, the retaining clips may need to be replaced or adjusted. By default, there are two strong clips to the right and two weak to the left (P/N 416128SP). See Figure 73.

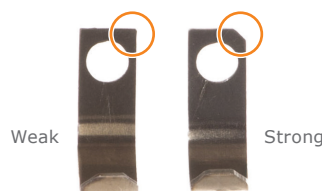

Figure 73. Retaining clips, weak and strong.

If the pipette rack in position **1**, **2** or **6** is moved out of its position by the robot, it may be because the retaining clips on the pipette rack are worn out and need to be replaced (P/N 414307SP). If replacing the clips does not solve the problem, please contact Biotage 1-Point Support.

Robot

If the robot fails to pick up pipette or DFE column tips or they fall off:

- » Check that the correct pipette/DFE column tip type is used.
- » Check that the pipette rack is in the correct position.
- » Check that the pipette rack, tip tray (delivered with the tips), and tips are not damaged.
- » Check that new tips are used.

Sample Cross-Contamination

To eliminate the risk of sample cross-contamination in the extraction plate or column rack, always use a flow-through plate in the waste position on the carousel and ensure that the pressure head seal is clean and not damaged (see “Replace the Pressure Head Seal” on page 35).

Solvent Contamination

If you suspect contamination after changing a solvent:

- » Clean the solvent pump and tubing thoroughly using the **Flush Solvent Inlets** function at the **Maintenance** view. Repeat the flush cycle until the pump and tubing are clean.
- » If necessary, change the solvent tubing as described in “Replace the Solvent Tubing” on page 32.

Solvent Pumps

If the pumped volume is too low:

- » Check the solvent level in the solvent bottle.
- » Check that the solvent bottle is placed at the same height as the system.
- » Flush the solvent pump and tubing repeatedly using the **Flush Solvent Inlets** function at the **Maintenance** view. If this does not help, check that the solvent's two screw connectors on the back wall (behind the sample rack) are securely tightened and flush again.

If solvent leaks from the solvent tubing in the back wall:

- » Check that the screw connectors are securely tightened.
- » Check that the correct tubing is used. Always use tubing supplied by Biotage.
- » Remove spillage; see “Clean the Interior of the System” on page 31.

If solvent leaks from behind the back wall, shut down the system, remove any solvents, samples, and waste inside the system, and contact Biotage 1-Point Support.

Ventilation Fan

If the integral system ventilation fan stops working, shut down the system, remove any solvents, samples, and waste inside the system, and contact Biotage 1-Point Support.

The system has open solvent reservoirs. If the ventilation fails and solvent vapors are not removed, an explosive environment can be generated. If the system is found with the door closed and the power off, you must ventilate the system properly before turning it back on. Follow the instructions in “Power Failure” on page 5.

Waste and Lifter

If the system does not evacuate waste:

- » Check that the system is connected to a vacuum pump or another vacuum source.
- » Check that the vacuum pump or source is operational.
- » Check that the vacuum tubing is not blocked.
- » Check that the extraction waste collector is not clogged. If clogged, clean as described in “Clean the Accessories” on page 31.
- » Check that the tube between the extraction waste collector and the waste reservoir is not clogged or blocked. If necessary, clean or replace the tube as described in “Clean or Replace the Waste Tubing” on page 33.
- » Remove any spillage; see “Clean the Interior of the System” on page 31.

If the extraction waste collector leaks, check that the tube between the extraction waste collector and the waste valve is securely tightened.

If the extraction waste collector does not reach its lower position, ensure that nothing is stuck underneath the extraction waste collector.

Biotage® Extrahera™ GLP Features

Clog Detection

- » If the plate/rack height scan fails, check that there is an extraction plate or rack in position **3** on the working area.
- » If the reference scan fails; check that the extraction plate/rack is supported with clog detection.
- » If the clog detection fails/gives false results:
 - » Check that your extraction plate/rack is supported with clog detection.
 - » Check that the solvent or solvent combination is compatible with clog detection.
 - » Change the clog sensitivity setting.

For more information, see the Extrahera GLP User Manual (P/N 417250).

General Information

Consumables and Accessories

Only genuine Biotage accessories must be used in the system. To order consumables and accessories, see contact information on the back of this document or visit our website www.biotage.com.

For a complete list, please visit our website www.biotage.com.

Part No.	Description	Qty
417508	Biotage® Extrahera™ LV-200 GLP Package - On Site Activation	1
415040	Configuration Kit 96 Positions Dual Flow	1
415604SP	Pressure Head Seal Self Adhesive 96 Positions	5
414253SP	Column Rack 96 x 1 mL (tabless)	1
121-5202	96-Well Collection Plate, 1 mL, Square	50
121-5203	96-Well Collection Plate, 2 mL, Square	50
121-5213	96-Well Collection Plate, 2 mL, Round	50
413991SP	Solvent Rack for 25 mL Reservoirs	1
414045SP	Solvent Reservoir 25 mL	25
417315SP	Solvent Rack for 40 mL Reservoirs	1
417324SP	Solvent Reservoir 40 mL	5
415560SP	Solvent Rack for 100 mL Reservoirs	1
414214SP	Solvent Reservoir 100 mL	5
417423SP	Pipette Rack Short (position 6 only)	1
414330SP	Kit, Solvent Inlet Lines (S1-S5)	5
414579	Solvent Safety Kit (inc. GL45 Caps, Filters and Bottles, Qty 5)	1
416920SP	Pipette Rack LV/MV (for Solvent, Sample, and DFE tips)	1
417008	Biotage Disposable Tips 50 µL, Clear	10x96
417009	Biotage Disposable Tips 200 µL, Clear	10x96
414141	Biotage Disposable Tips 1000 µL Clear	10x96
416444	Biotage Disposable Tips 1000 µL Wide Bore, Clear	10x96
414201SP	Flow-Through Plate for 96 Plates and Columns	1
414703SP	Spacer for µElution and SPEC Fixed Well Plates	1
416868SP	DFE Carousel Riser	1
414702SP	Matrix Tube Retaining Plate	1
416128SP	Retaining Clip Kit, 4 Weak and 4 Strong	1
414272SP	Waste Kit incl. Waste Reservoir 5 L and Tubing	1

Part No.	Description	Qty
414218SP	Pipette Tip Waste Bin	1
415985SP	Extraction Waste Collector for Lifter	1
414137SP	Waste Tubing	1
411916SP	Fuse, 4A/250VAC, 5x20mm	5
C67361	Mains Cord-Set (EU)	1
C65902	Mains Cord-Set (US/CA)	1
C128195	Mains Cord-Set (UK)	1
416440SP	Filter Unit	1
416441SP	Air Dryer	1
416492SP	Replacement Filters for Filter Unit	1
356330SP	Vacuum Pump ME1C, 100 to 230VAC 50/60Hz	1
415149	Handheld Barcode and QR Scanner	1

Manufacturer



Biotage GB Limited United Kingdom for
Biotage Sweden AB

Contact Us

Biotage Sweden AB

Box 8
SE-751 03 Uppsala
SWEDEN

Visiting address: Vimpelgatan 5

Phone: +46 18 56 59 00

Fax: +46 18 59 19 22

E-mail: info@biotage.com

Website: www.biotage.com

Please contact your local Biotage representative. See contact information on the back of this document or visit our website www.biotage.com.

Your Complete Partner for Effective Chemistry

Biotage is a worldwide supplier of instruments and accessories designed to facilitate the work of scientists in life sciences. With our deep knowledge of the industry, academic contacts and in-house R&D teams, we can deliver the best solutions to your challenges. We take great pride in our flexibility and ability to meet our customer's individual needs. With strong foundations in analytical, organic, process, and biomolecule chemistry, we can offer the widest range of solutions available on the market.

EUROPE

Main Office: +46 18 565900
Toll Free: +800 18 565710
Fax: +46 18 591922
Order Tel: +46 18 565710
Order Fax: +46 18 565705
order@biotage.com
Support Tel: +46 18 56 59 11
Support Fax: +46 18 56 57 11
eu-1-pointsupport@biotage.com

NORTH & LATIN AMERICA

Main Office: +1 704 654 4900
Toll Free: +1 800 446 4752
Fax: +1 704 654 4917
Order Tel: +1 704 654 4900
Order Fax: +1 434 296 8217
ordermailbox@biotage.com
Support Tel: +1 800 446 4752
Outside US: +1 704 654 4900
us-1-pointsupport@biotage.com

JAPAN

Tel: +81 3 5627 3123
Fax: +81 3 5627 3121
jp_order@biotage.com
jp-1-pointsupport@biotage.com

CHINA

Tel: +86 21 68162810
Fax: +86 21 68162829
cn_order@biotage.com
cn-1-pointsupport@biotage.com

KOREA

Tel: +82 31 706 8500
Fax: +82 31 706 8510
korea_info@biotage.com
kr-1-pointsupport@biotage.com

INDIA

Tel: +91 11 45653772
india@biotage.com

Distributors in other regions
are listed on www.biotage.com

Part Number: 417251-A

© 2021 Biotage. All rights reserved. No material may be reproduced or published without the written permission of Biotage. Information in this document is subject to change without notice and does not represent any commitment from Biotage. E&OE. A list of all trademarks owned by Biotage AB is available at www.biotage.com/legal. Other product and company names mentioned herein may be trademarks or registered trademarks and/or service marks of their respective owners, and are used only for explanation and to the owners' benefit, without intent to infringe.

